

Genau  
mein  
Klima.

KAMPMANN

Product  
Overview

Our cover building:

# Revo Munich

“Standard hotels were yesterday.” That’s the brand message on the hotel’s website. The trendy concept hotel with both rooms and serviced apartments opened in November 2022.

The stylish hotel has 607 rooms. It offers different types of rooms, from studios to loft apartments, which can be booked for a few days or up to several weeks. The community area provides a cinema, gaming areas or a bike workshop for guests to use.

Revo München GmbH is thus offering precisely what people are asking for today. **Serviced apartments** specialising in long stays have been experiencing a boom for some time.



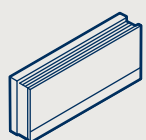

**612**  
Venkon



**91**  
KaCool D AF

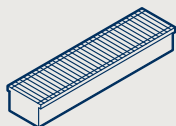

**42 metres**  
Katherm NK 380

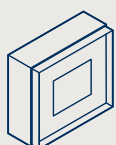

**36**  
KaControl SEL secondary air  
control panel with BACnet

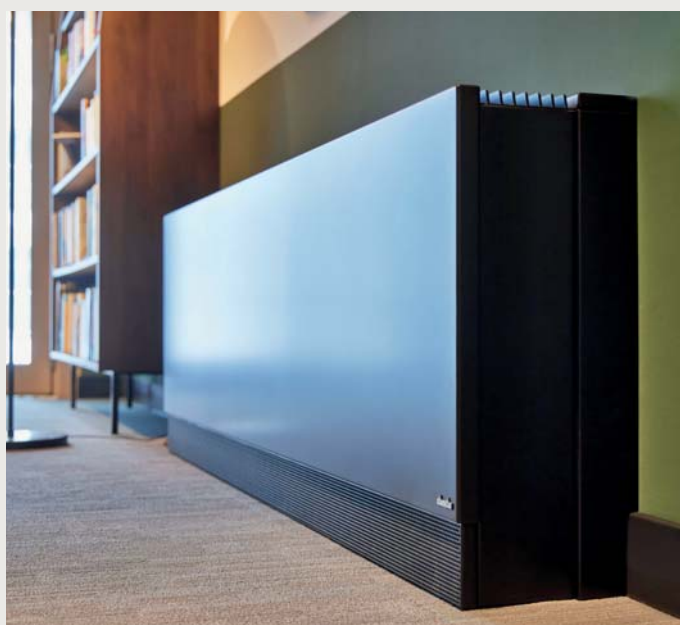

# Contents

Our product groups at a glance.  
Everything is under control with Kampmann.

## Trench technology

from page 6



## Air handling units

from page 48



## Local ventilation units

from page 92



## Unit heaters

from page 18



## Fan coils

from page 28

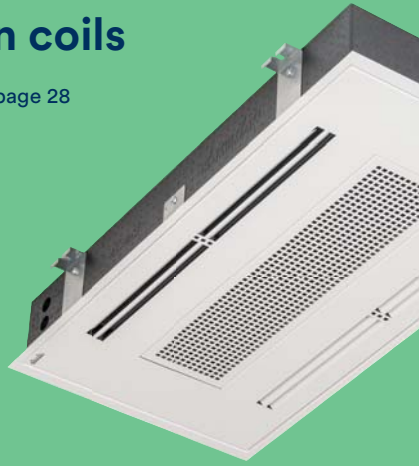

## Heat pump-based heaters

from page 44



## Diffusers

from page 58



## Door air curtains

from page 70



## Convectors

from page 82

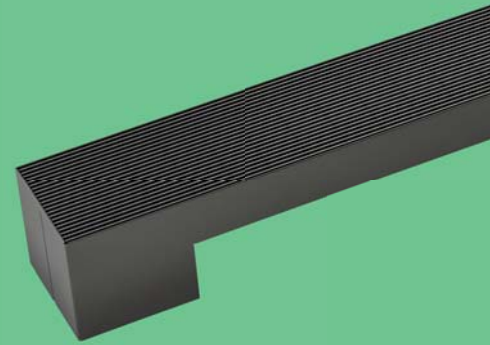

## Heat pumps and chillers

from page 100

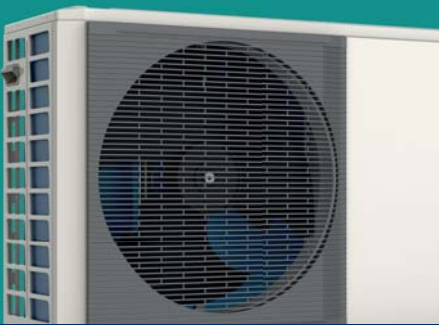

## Chilled ceiling systems

from page 108



## Control technology

from page 116



## Service

from page 132



## Company

Research & Development

from page 134



## Sustainability

from page 134



# Trench technology

The trend for large glazed façades and floor-to-ceiling windows continues unabated. Trench technology is the right choice for comfortable air conditioning that does not impede the view outside and effectively screens cold air.

- + large range from simple natural convection models to high-end units that provide heating, cooling and ventilation
- + low-temperature systems with EC fan assistance
- + fast-responsive heating and cooling with optimised air flow for comfortable air conditioning
- + future-proof cooling systems created in conjunction with chillers that use minimal refrigerant
- + primary air supply with models for displacement ventilation, with supply air modules for mixed ventilation or as induction units
- + end-to-end project support from the initial idea, site measurement, unit design and mouldings, to floor-based delivery and installation

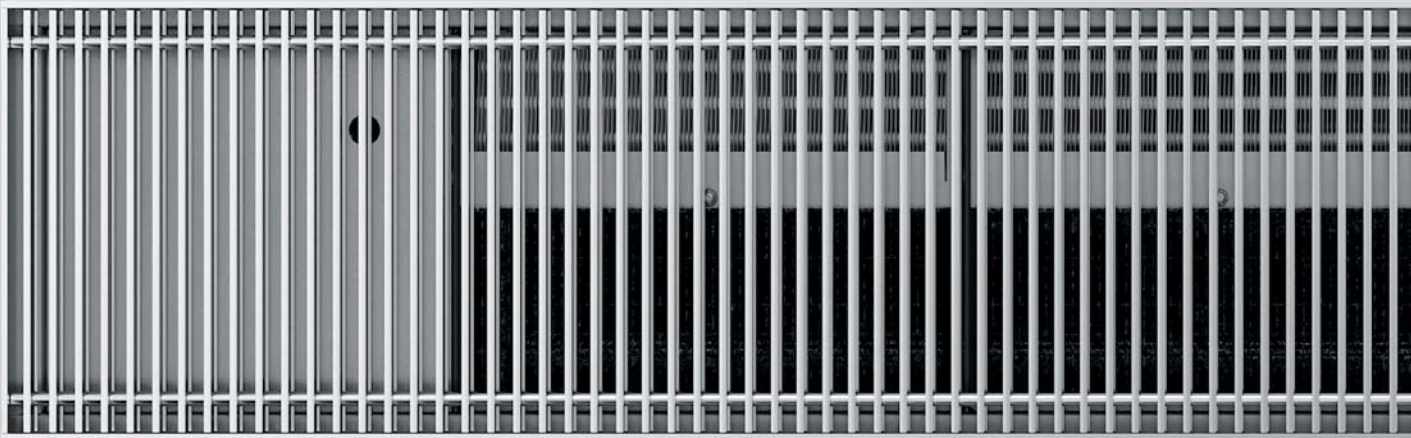

# 10,941 Katherm versions: technology leader, thanks to infinite possibilities.

How did we become one of the market leaders in trench technology? It is due to our **wide range of standard versions and also our willingness to deviate from them.** This provides our partners with the perfect combination of tried-and-test design and custom project solutions. Resulting in success for everyone. For you too?

## Modular system

Individual **connecting modules between the Kampmann trench systems** create an overall aesthetic look without disruptive interruptions. Don't let architectural challenges hold you back.

## 2-pipe with 4-pipe comfort

**Katherm HK E**

Either all-heating or all-cooling. That's 2-pipe systems for you. Or is it? **Katherm HK E units enable individual rooms to use an electric heating function when the rest of the building is being cooled.** Massively enhancing comfort. And the material and installation savings are huge compared to 4-pipe systems. You can now reduce CO<sub>2</sub> emissions along the value chain that will have a positive impact on the carbon footprint of the building. And even more so if you use more green power.





# Materials and colours



Oak \*



Merbau \*



Beech \*



Maple \*

\* Lacquered or oiled. Wooden grilles cannot be used for Katherm QE, QK nano, QL and ID units.



Aluminium natural anodised



Aluminium painted DB703 basalt grey



Aluminium bronze anodised



Aluminium black anodised



Aluminium bronze finish



Stainless steel polished



Stainless steel natural



Brass natural

Opt for aluminium grilles in a range of different anodised finishes. Or for different finishes of wooden grilles. Or maybe even polished stainless steel grilles?

## Diverse shapes

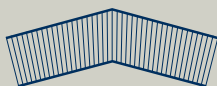

Adaptations and special designs are normal in projects. Katherm trench heaters can therefore be supplied for all geometries, incorporating mitred corners, curved sections, column cut-outs or angles.



## Low temperature

Trench technology has traditionally been used under floor-to-ceiling glazing. High-quality convectors and fan assistance have advanced them into the low-temperature era. They are also very efficient thanks to EC tangential fans.

# Our trench technology at a glance

		Heating	Supply air	Cooling	Heat Pump ready	Water-based coil	EC tangential fan	Electric heating coil
	<b>Katherm HK</b> > simple to clean in accordance with VDI 6022 > heat outputs tested independently in accordance with DIN EN 16430 > EC fan - efficient in terms of noise and energy	✓	✓	✓	✓	✓	✓	✗
	<b>Katherm HK E</b> > additional electric heating coil > variable heating and cooling in a 2-pipe system > sustainable material savings compared to 4-pipe systems	✓	✓	✓	✓	✓	✓	✓
	<b>Katherm QK</b> > whisper-quiet EC technology > optimised for low water temperature, heat outputs tested independently in accordance with DIN EN 16430 > shallow unit depths combined with high outputs	✓	✓	✗	✓	✓	✓	✗
	<b>Katherm QK nano</b> > extremely low overall height > usual quietness and high performance > delicate FineLine grille	✓	✗	✗	✓	✓	✓	✗
	<b>Katherm NK</b> > compact, performance-optimised > heat outputs tested independently in accordance with DIN EN 16430 > shallow unit depths combined with high outputs	✓	✓	✗	✗	✓	✗	✗
	<b>Katherm QE</b> > fast heating-up of the room > high heat output combined with low sound levels > minimum trench width and trench height for unobtrusive integration within a room	✓	✗	✗	✗	✗	✓	✓
	<b>Katherm QL</b> > evenly supplies rooms with prepared fresh air and heat > low-turbulence room ventilation for a pleasant indoor climate without draughts	✓	✓	✗	✗	✓	✗	✗
	<b>Katherm ID</b> > extremely silent by means of flow-optimised nozzles > nozzles can be replaced in operation to adjust output > supply air with post-cooling/heating by induction	✓	✓	✓	✗	✓	✗	✗

# Heat and cooling outputs

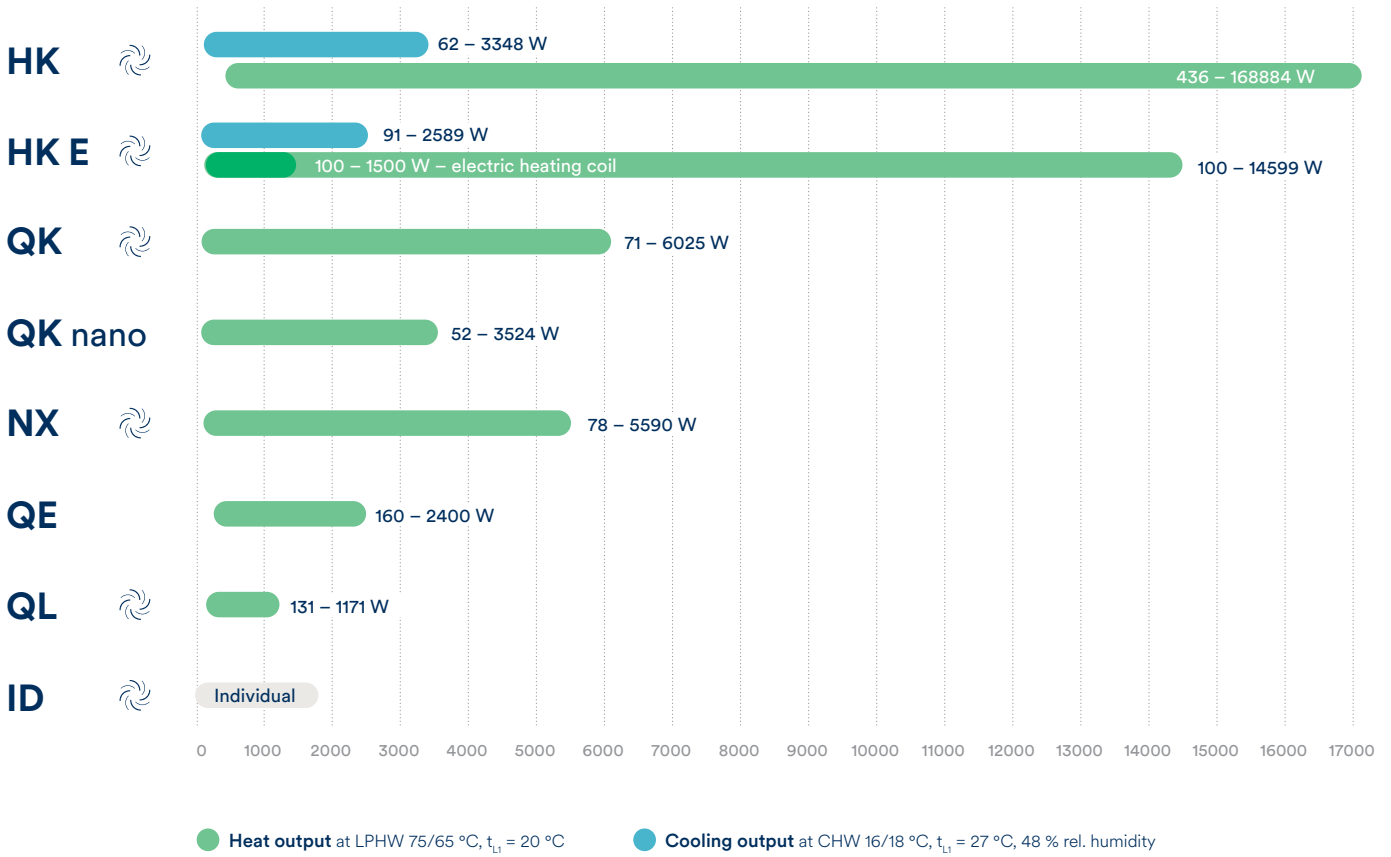

## Always fits.

	Widths	Lengths
HK	245 290 320 360	915   1200   1700   2000   2500   3000 950   1200   1700   2000   2500   3000 915   1200   1700   2000   2500   3000 950   1200   1350   1850   2250
HK E	290   320	915   1200   1700   2000   2500   3000
QK	190   215	min. 1000 max. 3200
QK nano	165	min. 900 max. 2700
NX	137   182   232 300   380	min. 800 max. 5000
QE	207	825   1250   1700
QL	300   350	700   1200   1700   2200   2700
ID	340	800   1000   1200   1400   1600

Dimensions in mm



# Your extended workbench

Our project department will work tirelessly for you.

When using trench technology, you also want to make the most of all the benefits of these systems. This can be a complex matter but is worth doing. All the more so as our project department is there for you. That way we'll get the most out of the units. **Often this means using a range of different Katherm models to provide different functions.** Let us design a system for your project, incorporating modules with mitred corners, recesses for cladding components or columns.

**We'll also perfectly manage the logistics to get the systems to site and on site.** The precise planned position of each unit is clearly printed on all packages. And it goes without saying that we also pack all units floor by floor. All cleverly worked out to let you concentrate on your job.

# From a reliable source

Katherm QL

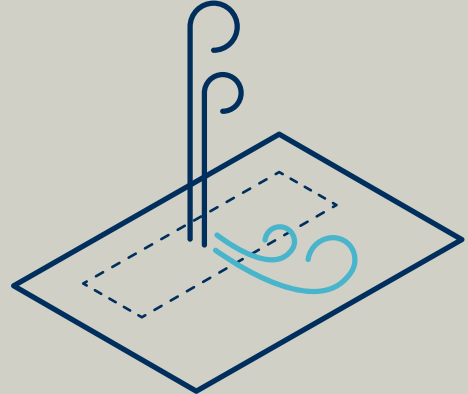

Two air flows emanate from this source. **Heated air rises up the glazed façade; fresh displacement air then enters the room at a low pulse to ensure complete comfort in the room.**



# Room automation

**Why not offer it?**

**Are you designing the air conditioning units but handing over their automation to someone else? Why? Three very good reasons why you need to change that.**

1. Offer our simple **KaControl** system together with the units. This will allow the operator to intuitively operate all the parameters that affect the room climate.
2. We can handle it. Your KaControl-system will be **configured precisely to your individual project.**
3. Do you plan to outsource the provision of a complex building automation system? Now you can extend your offering by equipping the Katherm units with our interface cards. The bottom line is that you will be saving your customer money.



## Hygienic

Katherm HK



It's unique! **Katherm HK** is one of the few trench technologies on the market to include a well-thought-out cleaning concept. The Katherm HK is hygienically flawless, thanks to its improved condensate discharge in cooling mode, coupled with the ease of cleaning of the condensate tray.

## BIM data

Use the BIM data sets for Kampmann Katherm trench technology for seamless planning processes. They include all unit dimensions, technical water and electrical connection dimensions and performance data.

## Site measurement

The site measurements are taken by our own Kampmann technicians using 2D or 3D lasers to avoid inaccuracies. This ensures a precise and efficient site measurement process. The dimensions will then be automatically handed over to our project department.

# It's your choice

## Katherm HK | Katherm HK E

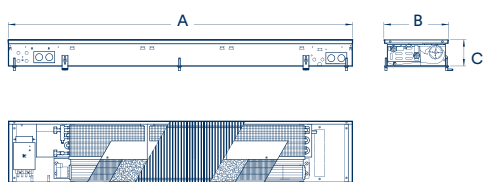

Width B	Height C	Length A	2-pipe		2-pipe electric heating coil			4-pipe	
			Heat output LPHW <sup>1)</sup>	Cooling output <sup>2)</sup>	Electric heat output <sup>3)</sup>	Heat output LPHW <sup>1)</sup>	Cooling output <sup>2)</sup>	Heat output LPHW <sup>1)</sup>	Cooling output <sup>2)</sup>
[mm]	[mm]	[mm]	[W]	[W]	[W]	[W]	[W]	[W]	[W]
320	130	915	971 – 2373	108 – 332	200 – 500	942 – 1960	91 – 274	436 – 1085	105 – 321
320	130	1200	1485 – 3438	157 – 537	400 – 1000	1659 – 3248	153 – 517	726 – 1809	153 – 517
320	130	1700	1696 – 5232	223 – 964	400 – 1000	1980 – 4933	214 – 927	1307 – 3256	214 – 927
320	130	2000	1884 – 5814	247 – 1071	400 – 1000	2200 – 5481	238 – 1030	1452 – 3618	238 – 1030
320	130	2500	2155 – 7866	324 – 1500	600 – 1500	3080 – 7673	333 – 1442	2033 – 5065	333 – 1442
320	130	3000	2884 – 10310	430 – 1928	600 – 1500	3484 – 9716	411 – 1854	2614 – 6512	411 – 1854
245	160	915	637 – 1452	66 – 251	–	–	–	462 – 1053	62 – 237
245	160	1200	1061 – 2420	110 – 419	–	–	–	770 – 1755	103 – 394
245	160	1700	1910 – 4355	198 – 754	–	–	–	1385 – 3158	186 – 710
245	160	2000	2123 – 4839	220 – 837	–	–	–	1539 – 3509	207 – 789
245	160	2500	2972 – 6775	308 – 1172	–	–	–	2155 – 4913	290 – 1104
245	160	3000	3821 – 8710	395 – 1507	–	–	–	2771 – 6316	372 – 1420
290	160	950	1057 – 3286	114 – 486	200 – 500	993 – 3116	108 – 453	514 – 1639	112 – 476
290	160	1200	1599 – 4851	165 – 801	400 – 1000	1509 – 4572	156 – 745	852 – 2718	162 – 785
290	160	1700	1657 – 7262	212 – 1284	600 – 1500	1541 – 6754	197 – 1194	1366 – 4357	207 – 1258
290	160	2000	2149 – 9420	275 – 1665	600 – 1500	1999 – 8760	255 – 1548	1771 – 5652	269 – 1632
290	160	2500	2283 – 12055	333 – 2148	600 – 1500	2100 – 11178	307 – 1998	2285 – 7291	347 – 2105
290	160	3000	3085 – 15715	444 – 2783	600 – 1500	2835 – 14599	410 – 2589	2961 – 9448	435 – 2728
360	210	950	1223 – 4645	120 – 818	–	–	–	643 – 2982	114 – 771
360	210	1200	1933 – 7152	185 – 1352	–	–	–	1066 – 4944	176 – 1273
360	210	1350	2332 – 8667	222 – 1674	–	–	–	1320 – 6121	211 – 1576
360	210	1850	2708 – 12555	281 – 2489	–	–	–	1964 – 9104	264 – 2344
360	210	2250	3642 – 16884	377 – 3348	–	–	–	2641 – 12243	356 – 3153

<sup>1)</sup> at LPHW 75/65 °C, t<sub>L</sub> = 20 °C, with fan-assisted convection  
<sup>2)</sup> at CHW 16/18 °C, t<sub>L</sub> = 27 °C, 48% relative humidity with fan-assisted convection  
<sup>3)</sup> when operated with an electric heating coil

## Katherm QE

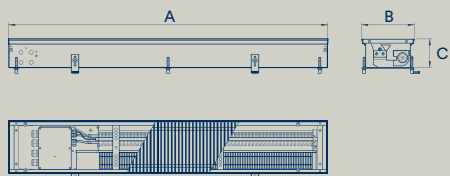

Width B	Height C	Length A	Max. heat output
[mm]	[mm]	[mm]	[W]
207	112	825	160 – 800
207	112	1250	320 – 1600
207	112	1700	480 – 2400

## Katherm NK

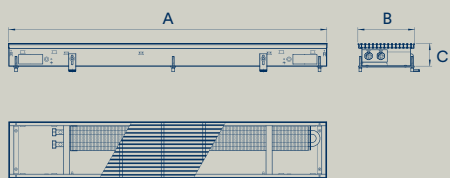

Width B	Height C	Length A	Heat output <sup>1)</sup>
[mm]	[mm]	[mm]	[W]
137	92	800 – 5000	78 – 981
137	120	800 – 5000	84 – 1050
182	92	800 – 5000	132 – 1295
182	120	800 – 5000	162 – 1594
182	150	800 – 5000	206 – 1857
182	200	800 – 5000	232 – 2084
232	92	800 – 5000	157 – 1530
232	120	800 – 5000	193 – 1881
232	150	800 – 5000	309 – 2778
232	200	800 – 5000	334 – 3010
300	92	800 – 5000	209 – 2036
300	120	800 – 5000	268 – 2609
300	150	800 – 5000	394 – 3545
300	200	800 – 5000	445 – 4003
380	92	800 – 5000	279 – 2717
380	120	800 – 5000	344 – 3353
380	150	800 – 5000	485 – 4362
380	200	800 – 5000	621 – 5590

<sup>1)</sup>at LPHW 75 / 65 °C, t<sub>1</sub> = 20 °C



# Katherm QK

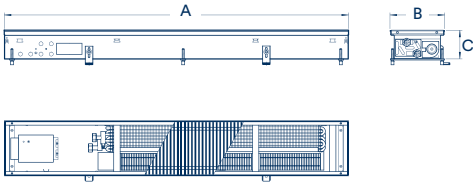

Width B	Height C	Length A	Heat output <sup>1)</sup>
[mm]	[mm]	[mm]	[W]
190	112	1000 – 3200	71 – 5781
215	112	1000 – 3200	87 – 6025

<sup>1)</sup> at LPHW 75/65 °C, t<sub>Li</sub> = 20 °C, with a 12 mm grille spacing, free cross-section approx. 70%

# Katherm QK nano

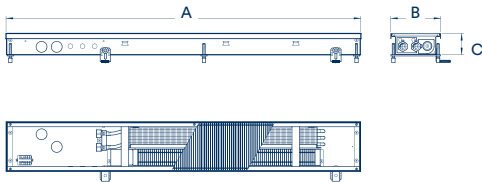

Width B	Height C	Length A		Heat output <sup>1)</sup>
		KaControl electromechanical 230 V	Control electromechanical 24 V	
[mm]	[mm]	[mm]	[mm]	[W]
165	70	1100	900	52 – 772
165	70	1600	1400	104 – 1545
165	70	2000	1800	156 – 2317
165	70	2300	2100	196 – 2912
165	70	2700	2600	238 – 3524

<sup>1)</sup> at LPHW 75/65°C, t<sub>Li</sub> = 20°C

Your digital product finder at  
[www.kampmanngroup.com](http://www.kampmanngroup.com)

Calculate your product online:  
[kampmanngroup.com](http://kampmanngroup.com) > Products > Trench technology

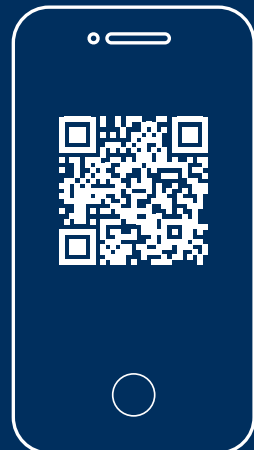





# Unit heaters

Suitable for use as wall- or ceiling-mounted units for heating, cooling or ventilation in high-ceilinged buildings, industrial buildings, showrooms etc. – as recirculating air, mixed air or primary air units.

- + proven classics, always up to date. Kampmann unit heaters set the standard and are continuously being further developed
- + future-proof EC technology for energy-efficient and ERP-compliant operation
- + from industrial uses to occupied zones. Sturdy steel housings to design units
- + on-board control: EC technology includes control electronics for simple and convenient control
- + heating and cooling with one unit – whether in simple industrial applications or as a comfort system in retail stores and high-end large spaces
- + unit heaters as a component of hybrid ventilation systems: central ventilation, local temperature control



# Our number one The TOP

Our unit heater with the simple name – “TOP” – has been at the forefront of the market for over 30 years. How do we do it? We don't rest on our laurels! Simply the ongoing development of our Number One and all other unit heaters ensures that we always remain TOP in terms of output, energy efficiency and control comfort. And our design and trade partners do too.

## Gas-free: heat pumps for existing and new industrial sheds

Are you looking for an energy-efficient heating system for your industrial shed but without gas? Our solution: **low water temperature systems**.

Save costs at the same time lower CO<sub>2</sub> emissions compared to gas-fired systems by combining **unit heaters** with **heat pumps** to heat large spaces, industrial sheds and retail spaces.

Heat pumps supply the unit heaters with low-temperature low pressure hot water LPHW for maximum efficiency. The system also produces pleasant temperatures and a comfortable indoor environment without the risk of draughts in the occupied zone.

## When the summer warmth arrives

TOP C



Introduce cool air into your hall on hot days with the TOP C. **When your client asks for hall heating, offer cooling as an option.** Up to now only supplied as a project solution, this heating and cooling all-rounder is set to become a standard product.

# Simple, efficient, cost-effective

## TIP

The little brother of the TOP unit heater is ideal for heating halls and workshops on simpler projects. **Unbeatable in terms of value for money**, it controls efficiently, coupled with space-saving installation.



## Industry

**Our TOP is the unit of choice when you are faced with tough conditions.** Ideal when you have to deal with oil in the air, thanks to its sturdy housing, extensive accessories and custom designs. And, with EC technology, you can now simply design **convenient control systems with our KaControl system** or via an interface, such as linked to KNX, BACnet or Modbus.

## Retail outlets

The Ultra unit heater is synonymous with efficient and fast-response air conditioning in retail outlets, recognisable by its hexagonal housing design. **Unit heaters for heating and cooling really come into their own during the shoulder months in spring and autumn.** And it also makes sense to use water as the carrier medium: energy-efficient, safe and low-maintenance.



# Heating and cooling in low temperature mode

## Ultra Allround

Developed as a high-quality design unit, the Ultra Allround is ideal for use with open ceiling concepts in public and industrial areas where it can be operated up to a ceiling height of 7 m. The circular encased housing is designed to discharge warm or cold air into the occupied zone, as required, creating a comfortable climate at all times.



As the unit is designed for operation with low water temperatures, it can be operated in new buildings as well as in refurbished buildings equipped with a heat pump.

Perfectly fitting EPP components enable the operator to maximise the benefits of the material: accurate air flow in the unit with a high level of air-tightness for maximum efficiency.

## Control



Unit heaters are operated using our KaControl system and **up to 60 units can be controlled in a maximum of 24 zones with the KaControl SEL secondary air control panel**. Standardised interfaces also enable the units to be integrated into higher-level networks or building automation systems, such as BACnet, Modbus or KNX.

## Minimal noise levels

We only notice how much high noise levels affect us when they are abruptly interrupted. **Our continuously variably controlled unit heaters generate less stress, as they only operate within the power range actually required.** Not one revolution too many or too few. Generating only the noise emissions that are absolutely necessary. At the same time using whisper-quiet sickle-blade fans.

## It's lonely at the top

Our size 8 TOP unit heater really stands out, as it is unrivalled in terms of installation height. It copes with **ceiling heights of up to 20 m** with our KaMax air outlet.



# Real team players

## Hybrid ventilation concept

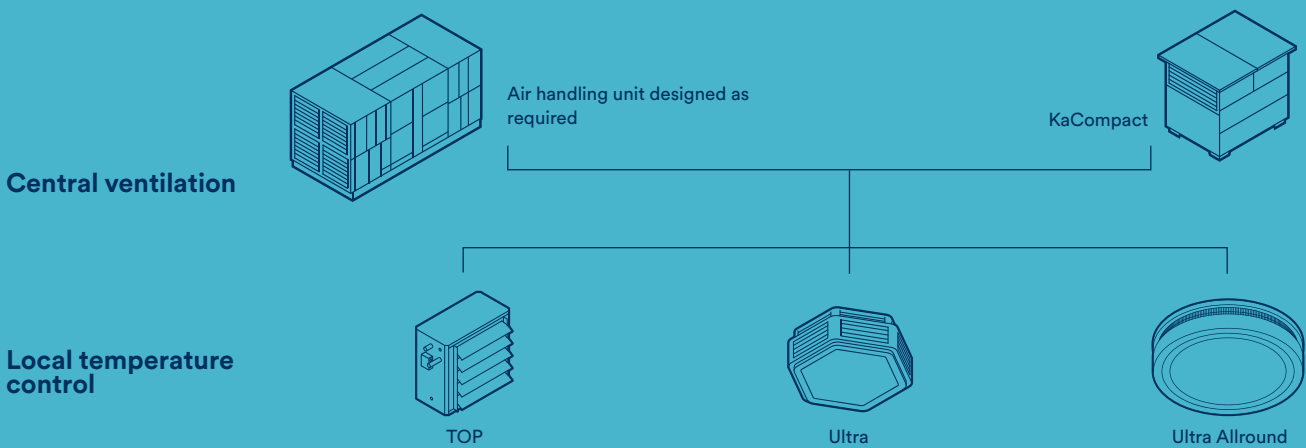

Hybrid ventilation systems are **bidirectional ventilation systems with efficient heat recovery.**

**Temperature control is provided by local units inside the room** and not by the central ventilation unit (air handling unit). Primary air is only fed in if required. A CO<sub>2</sub> sensor monitors this specific requirement. Otherwise, the local units are operated with secondary air.

**Hybrid ventilation systems make sense, as the use of water as a carrier medium is more efficient than air.**

Our unit heaters are ideal for this in conjunction with our Kompakt ventilation unit or individually configured air handling units from our specialist ventilation brand NOVA.

# Our unit heaters at a glance



## Unit heaters for factories and workshops



### TIP

- > unbeatable in terms of value for money
- > sickle-blade, whisper-quiet fan with optimised full nozzle
- > neutral in colour, hard-wearing and tough



### TOP

- > design-based range of equipment, "TOP" value for money
- > whisper-quiet sickle-blade fan with energy-efficient EC technology complies with ErP requirements
- > heat exchanger and fan options for the most diverse applications



### TOP C

- > heating or cooling in a 2-pipe system with one unit
- > whisper-quiet sickle-blade fan with energy-efficient EC technology complies with ErP requirements
- > two capacity levels of copper/aluminium heat exchanger

## Unit heaters for large high-end spaces



### Ultra

- > minimal height due to circular heat exchanger
- > hexagonal housing design for optimum air distribution with heating and cooling
- > whisper-quiet sickle-blade fan with energy-efficient EC technology complies with ErP requirements



### Ultra Allround

- > installation heights of up to seven metres are possible
- > efficient climate due to minimal temperature stratification
- > comfortable due to intelligent air routing

## Mobile unit heaters for construction sites



### Site heaters

- > all site heaters are available on short delivery times
- > no need to stop working on site because of the cold
- > heated, dried and ice-free sites



# Fits every time

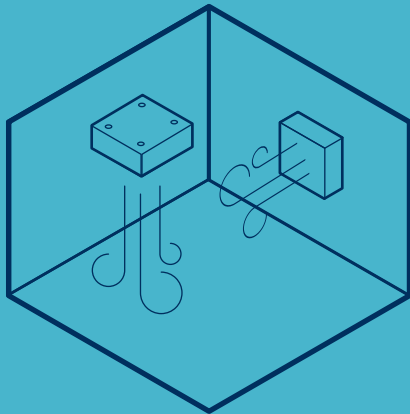

## TIP



- Size 4 540 × 500 × 320 mm
- Size 5 640 × 600 × 320 mm
- Size 6 740 × 700 × 320 mm

## TOP | TOP C



- Size 4 540 × 500 × 360 mm
- Size 5 640 × 600 × 360 mm
- Size 6 740 × 700 × 320 mm
- Size 7 840 × 800 × 360 mm
- Size 8 940 × 900 × 670 mm

## Ultra

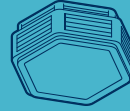

- Size 7 840 × 750 × 330 mm
- Size 8 1,004 × 900 × 330 mm
- Size 9 1,177 × 1,050 × 330 mm

## Ultra Allround

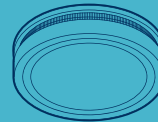

1300 × 1300 × 516 mm

## Site heaters



- Size 4 540 × 500 × 320 mm
- Size 5 640 × 600 × 320 mm
- Size 6 740 × 700 × 320 mm

Wall-mounted	Ceiling-mounted
TIP	TIP
TOP	TOP
TOP C*	TOP C (horizontal air outlet)*
Site heaters	Ultra, Ultra Allround*
	Site heaters

# Heat and cooling outputs

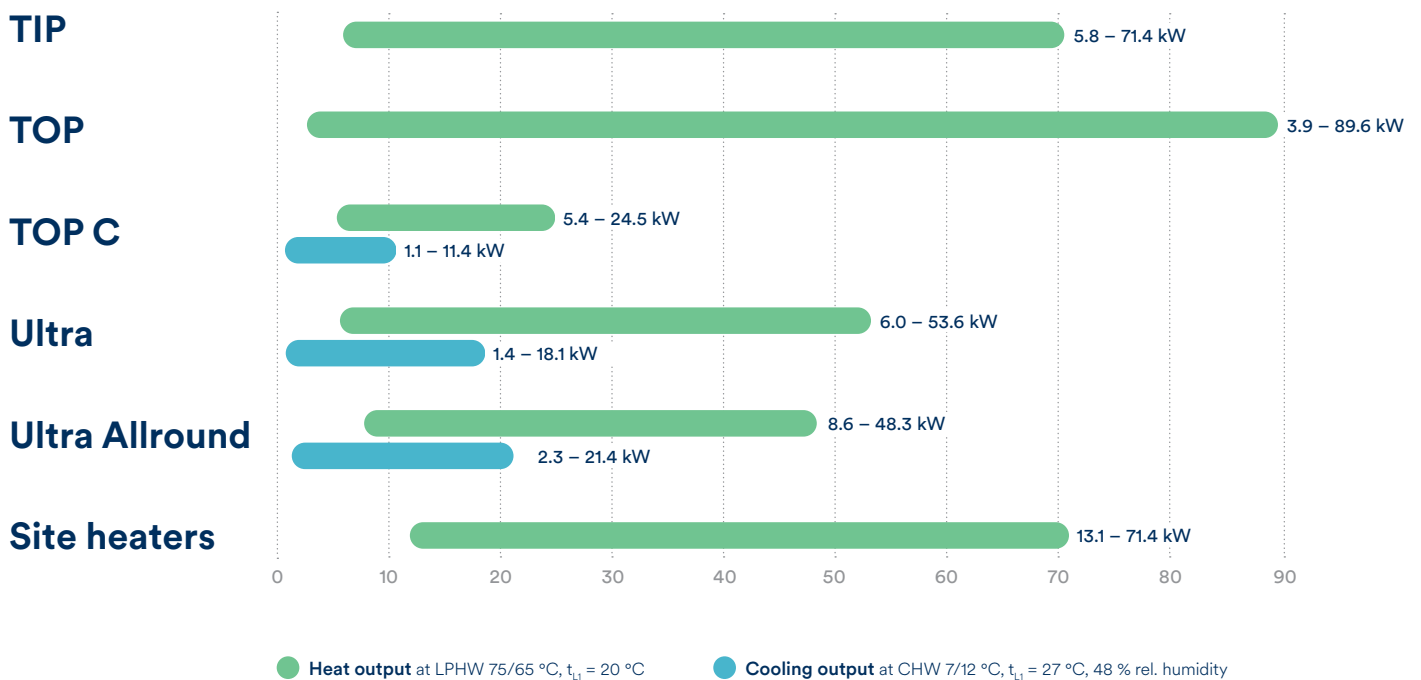

# It's your choice

## Ultra

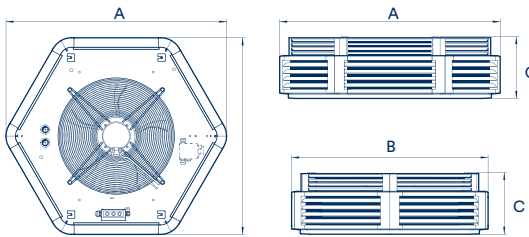

Version	Size	Width A	Depth B	Height C	Heat output <sup>1)</sup>	Cooling output <sup>2)</sup>	Cooling output <sup>3)</sup>	Air volume flow
		[mm]	[mm]	[mm]	[kW]	[kW]	[kW]	[m <sup>3</sup> /h]
EC fan, 230 V, high speed	73	840	750	330	6.5 – 15.9	-	-	590 – 1500
	84	1004	900	330	6.0 – 20.5	3.0 – 7.5	1.4 – 3.7	500 – 1860
	85	1004	900	330	7.4 – 33.2	3.7 – 12.0	1.7 – 5.7	520 – 2970
	96	1177	1050	330	10.2 – 53.6	5.1 – 18.1	2.2 – 8.7	680 – 5620
EC fan, 230 V, low fan speed	96	1177	1050	330	8.2 – 40.1	4.2 – 14.0	1.6 – 6.7	440 – 3930

<sup>1)</sup> at LPHW 75/65 °C, t<sub>Li</sub> = 20 °C

<sup>2)</sup> at CHW 7/12°C, t<sub>Li</sub> = 27 °C, 48% rel. humidity

<sup>3)</sup> at CHW 16/18°C, t<sub>Li</sub> = 27 °C, 48% rel. humidity

## Ultra Allround

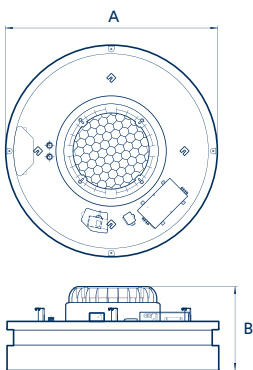

diameter (A)	Height (B)	Heat output <sup>1)</sup>	Cooling output <sup>2)</sup>	Air volume flow	Sound power level
[mm]	[mm]	[kW]	[kW]	[m <sup>3</sup> /h]	[dB(A)]
1300	516	8.6 – 39.4	3.0 – 10.9	430 – 3480	21 – 70
1300	516	9.8 – 48.3	4.4 – 21.4	630 – 4140	27 – 72

<sup>1)</sup> at LPHW 75/65 °C, t<sub>Li</sub> = 20 °C

<sup>2)</sup> at CHW 7/12 °C, t<sub>Li</sub> = 27 °C, 48 % rel. humidity

## TIP

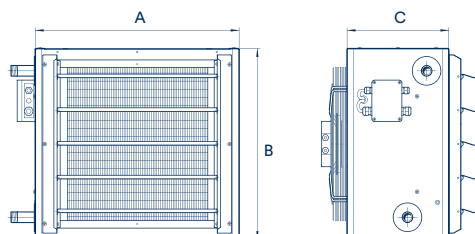

Version	Size	Width A	Height B	Depth C	Heat output <sup>1)</sup>	Air volume flow
		[mm]	[mm]	[mm]	[kW]	[m <sup>3</sup> /h]
EC fan, 230 V, high speed	4	540	500	320	6.4 – 18.4	520 – 2720
	5	640	600	320	4.4 – 37.5	260 – 4860
	6	740	700	320	6.9 – 48.7	430 – 6900
EC fan, 230 V, low speed	4	540	500	320	5.8 – 15.3	450 – 2210
	5	640	600	320	6.5 – 26.0	480 – 3370

<sup>1)</sup> at LPHW 75/65 °C, t<sub>Li</sub> = 20 °C

# TOP

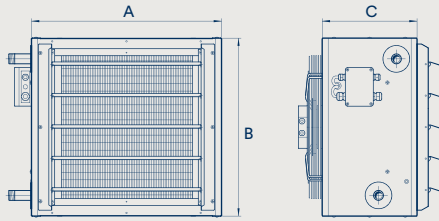

Copper-aluminium heat exchanger						
Version	Size	Width A	Height B	Depth C	Heat output <sup>1)</sup>	Air volume flow
		[mm]	[mm]	[mm]	[kW]	[m <sup>3</sup> /h]
EC fan, 230 V, high speed	4	540	500	320	6.4 – 18.4	520 – 2720
	5	640	600	320	4.4 – 37.5	260 – 4860
	6	740	700	320	6.9 – 48.7	430 – 6900
	7	840	800	360	14.2 – 71.4	970 – 9680
	8	940	900	670	19.2 – 89.4	1370 – 11800
EC fan, 230 V, low speed	4	540	500	320	5.8 – 15.3	450 – 2210
	5	640	600	320	6.5 – 26.0	480 – 3370
	7	840	800	360	10.7 – 55.6	590 – 7820
Heat exchanger, galvanised steel						
EC fan, 230 V, high speed	4	540	500	320	6.0 – 18.1	550 – 2770
	5	640	600	320	7.4 – 34.0	640 – 4800
	6	740	700	320	9.5 – 44.0	790 – 5860
	7	840	800	360	14.4 – 59.1	1180 – 8900
	8	940	900	670	19.3 – 89.6	1920 – 12230
EC fan, 230 V, low speed	4	540	500	320	5.5 – 14.9	480 – 2200
	5	640	600	320	9.0 – 24.8	850 – 3420
	7	840	800	360	12.1 – 46.4	910 – 7070
Heat exchanger, galvanised steel, cross-counterflow						
EC fan, 230 V, high speed	4	540	500	320	4.4 – 13.4 <sup>2)</sup>	550 – 2770
	5	640	600	320	5.9 – 21.7 <sup>2)</sup>	640 – 4800
	6	740	700	320	7.6 – 31.1 <sup>2)</sup>	790 – 5860
	7	840	800	360	14.2 – 49.2 <sup>2)</sup>	1180 – 8900
EC fan, 230 V, low speed	4	540	500	320	3.9 – 11.7 <sup>2)</sup>	480 – 2200
	5	640	600	320	7.5 – 17.8 <sup>2)</sup>	850 – 3420
	7	840	800	360	12.3 – 41.3 <sup>2)</sup>	910 – 7070

<sup>1)</sup> at LPHW 75/65 °C, t<sub>Li</sub> = 20 °C

<sup>2)</sup> at LPHW 80/40 °C, t<sub>Li</sub> = 20 °C

## Your digital product finder at [www.kampmanngroup.com](http://www.kampmanngroup.com)

Calculate your product online:

[kampmanngroup.com](http://kampmanngroup.com) > Products > Unit heaters



# Fan coils

The cooling of buildings is becoming increasingly relevant.

The typical products employed here include fan coils, which, as water-based systems, are as current and useful as never before. No wonder with all their benefits and versatile uses.

Kampmann is at the forefront in different sectors.

- + cooling and heating in conjunction with heat pumps/chillers
- + no refrigerant circulating in the building and only small quantities used in the chiller
- + fast response times thanks to powerful and efficient EC fans
- + for every requirement for installation in and under the ceiling, suspended on the wall or free-standing
- + in hybrid systems to supply primary air and control the temperature of the recirculating air
- + for air conditioning in addition to surface temperature control

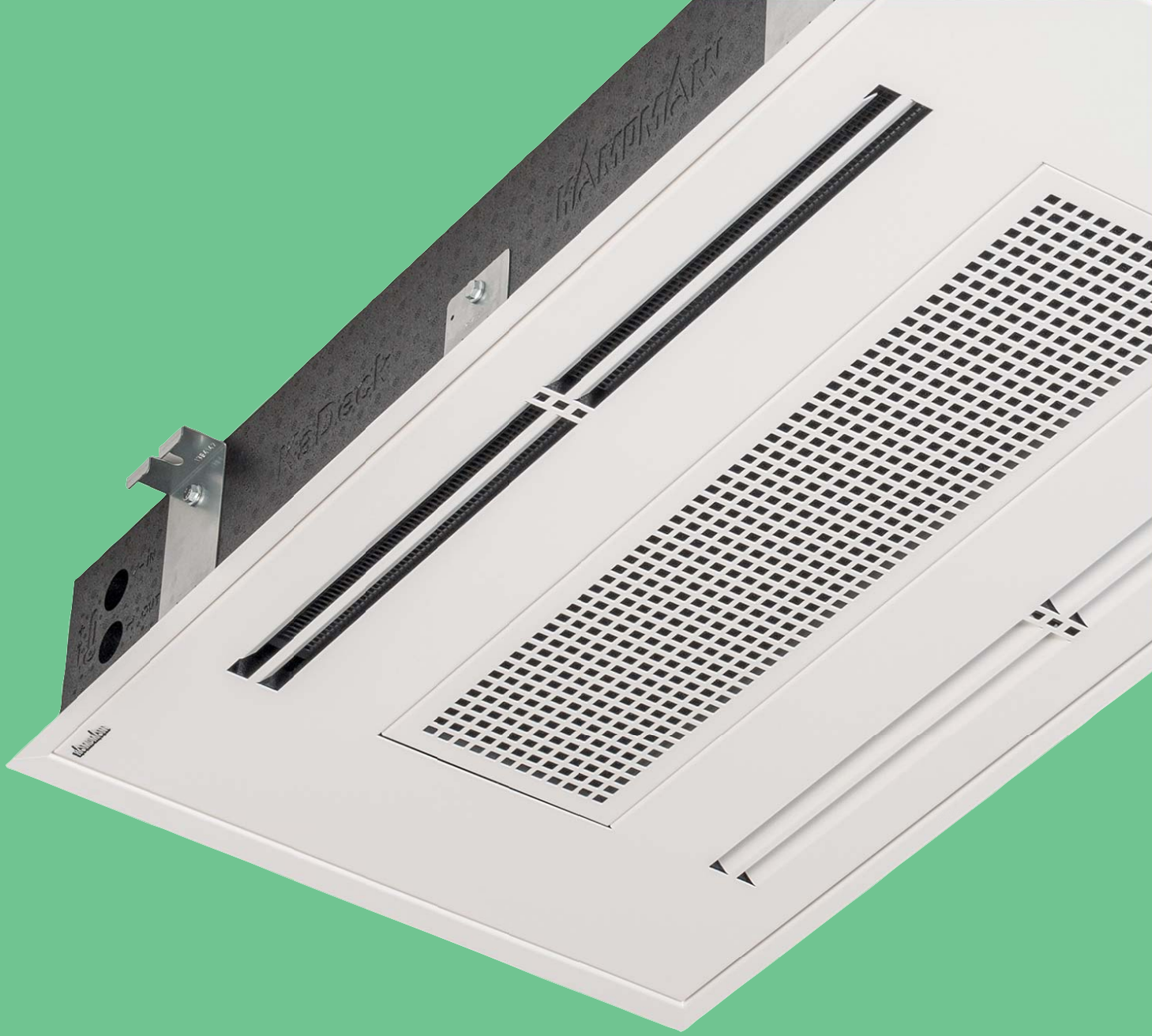

# Calling all sensible people

Admittedly “sensible” does not come across as a catchy advertising message. But what if it’s the truth? Sensible designers use fan coils when users ask for a good indoor climate. That’s what fan coils provide. **In the middle of summer, as in winter, and in the shoulder months as well when other systems sometimes struggle. Water-based fan coil systems are also subject to minimal safety requirements and can be adapted to developments on the refrigerant market – so sensible after all?**

## Market-leading in low-noise

Venkon

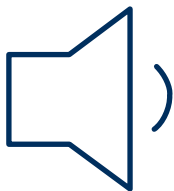

Venkon fan coils fulfil all expectations for a quiet environment, thanks to their energy-saving EC technology. Peace and quiet so that you can focus on important matters. **Market-leading quiet and nonetheless outstanding outputs at higher fan speed ranges.**



# Hygiene experts

Venkon, KaCool D HC and KaCool D HY provide VDI 6022-compliant air conditioning with their sealed surfaces, ideal cleaning options and ePM10 > 50% filters for totally hygienic room air in offices or hotel bedrooms.

And, thanks to their motorised H14 filter for Venkon units, HEPA filters now form an integral part of sustainable air conditioning systems.



# Real team players

## Hybrid ventilation concept

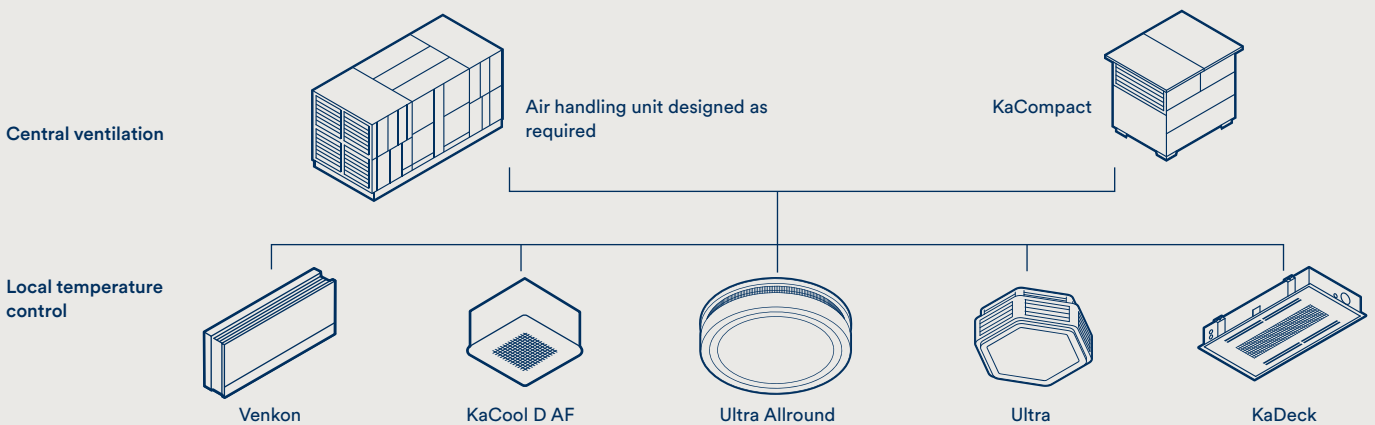

Hybrid ventilation systems are **bidirectional ventilation systems with efficient heat recovery**.

**Temperature control is provided by local units inside the room** and not by the central ventilation unit (air handling unit). Primary air is only fed in if required. A CO<sub>2</sub> sensor monitors this specific requirement. Otherwise, the local units are operated with secondary air. **Hybrid ventilation systems make sense, as the use of water as a carrier medium is more efficient than air**. Our fan coils are ideal for this in conjunction with our Kompakt ventilation unit or individually configured air handling units from our specialist ventilation brand NOVA.

# Our fan coils at a glance



## Venkon

- > ultra-versatile in terms of length and appearance
- > hygiene-compliant in accordance with VDI 6022 in conjunction with optional ePM10>50% filter, easy-clean
- > versatile combination by the use of basic unit and casing



## PowerKon LT

- > high heat outputs with low system temperatures
- > up to 25% improved efficiency with a heat pump compared to high-temperature systems
- > eligible for government funding with the installation of a heat pump



## Venkon XL

- > XL performance guaranteed
- > for higher external pressure requirements
- > highly optimised, large heat exchanger



## KaDeck

- > ideal for shallow suspended ceiling heights, installation height of only 165 mm
- > all components (including valves) can be accessed without tools, no inspection openings needed on site
- > thermally and acoustically insulated housing made of EPP (expanded polypropylene)



## KaCool D AF

- > AtmosFeel for maximum comfort
- > minimalist cassette design
- > whisper-quiet with EC fan





### **KaCool W**

- > design wall-mounted unit for heating and cooling
- > whisper-quiet with EC fan
- > optional condensate pump can be fitted within the housing



### **KaCool D HC**

- > certified compliant with the Hygiene Directive DIN 1946-4 and VDI 6022
- > all components can be accessed and cleaned without tools
- > suspended ceiling models fit ceiling grid dimensions (625 x 625 mm)



### **KaCool D HY**

- > ceiling cassette for heating and cooling
- > ideal in rooms with stringent hygiene requirements
- > VDI 6022-compliant
- > including attractive and low-maintenance metal trim



### **Ultra Allround**

- > minimal height due to circular heat exchanger
- > hexagonal housing design for optimum air distribution with heating and cooling
- > whisper-quiet sickle-blade fan with energy-efficient EC technology complies with ErP requirements



### **Ultra**

- > minimal height due to circular heat exchanger
- > hexagonal housing design for optimum air distribution with heating and cooling
- > whisper-quiet sickle-blade fan with energy-efficient EC technology complies with ErP requirements

# Heat and cooling outputs

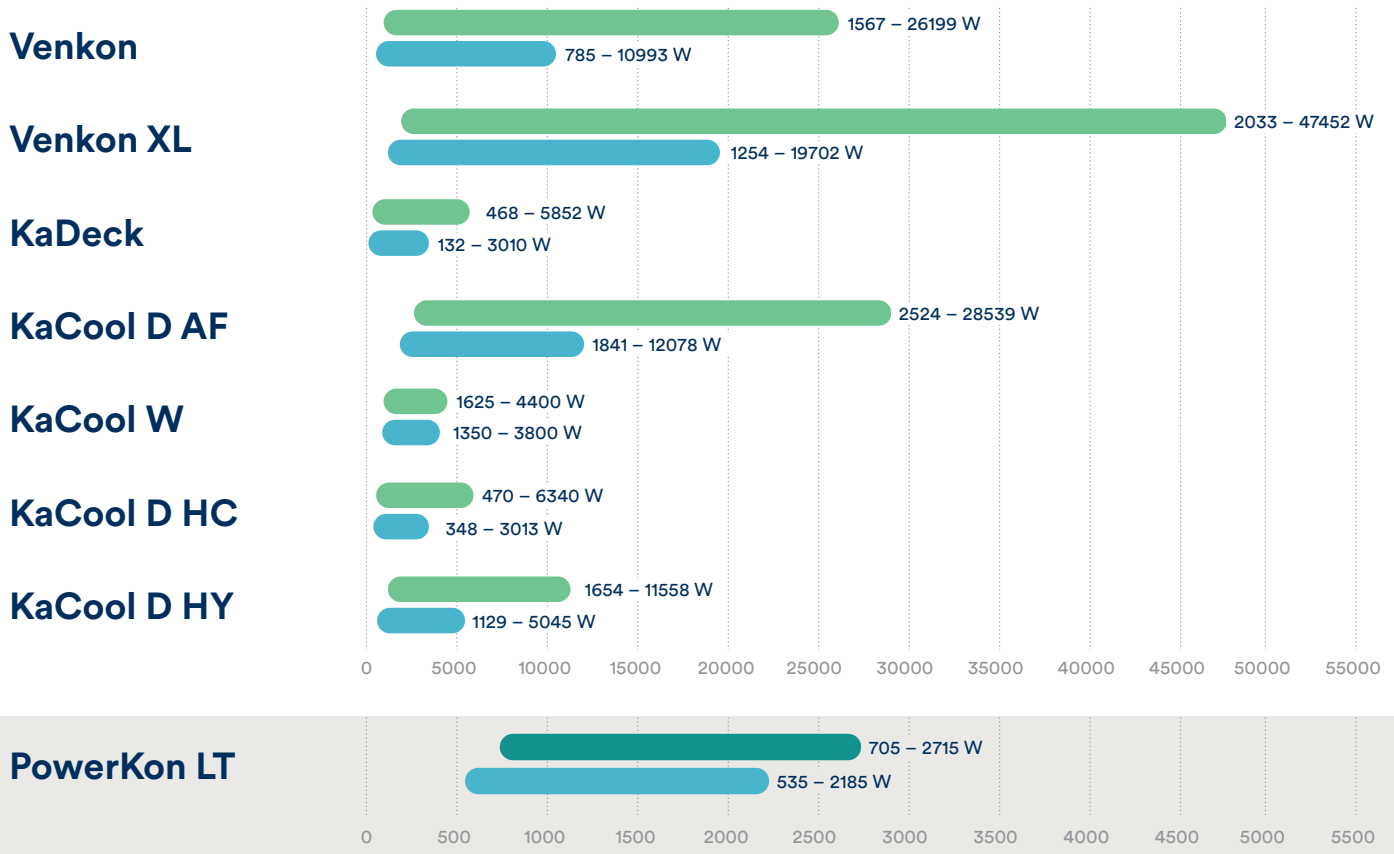

● Heat output at LPHW 75/65 °C,  $t_{li} = 20\text{ °C}$ 
● Heat output at LPHW 45/40 °C,  $t_{li} = 20\text{ °C}$ 
● Cooling output at CHW 7/12 °C,  $t_{li} = 27\text{ °C}$ , 48 % rel. humidity

## Installation options

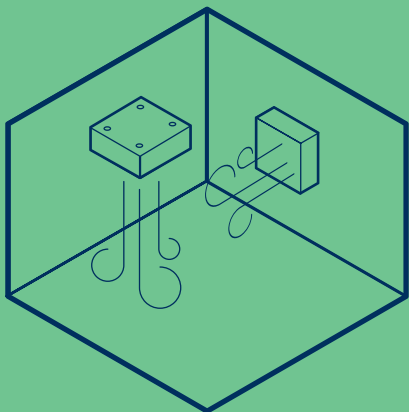

### Wall-mounted

Venkon  
KaCool W

### Ceiling-mounted

Ultra  
Venkon  
Venkon XL  
KaDeck  
KaCool D AF  
KaCool D HC  
KaCool D HY

## Matching accessories



**KaController** with one-touch operation or side buttons, 24 V wall-mounted room control unit with integral room temperature sensor, also in black



**Interface cards** KNX/Modbus RTU for connection to building automation networks, factory-fitted or supplied loose



# Perfect duo

Venkon XL and DAL358

## For high output with high external pressure

Have you come across office projects like this? High cooling and heating requirement but a need to be quick to respond and quiet. So ban the fan coils to the corridor.

The Venkon XL supplies connected swirl diffusers with the required conditioned air from the suspended ceiling.

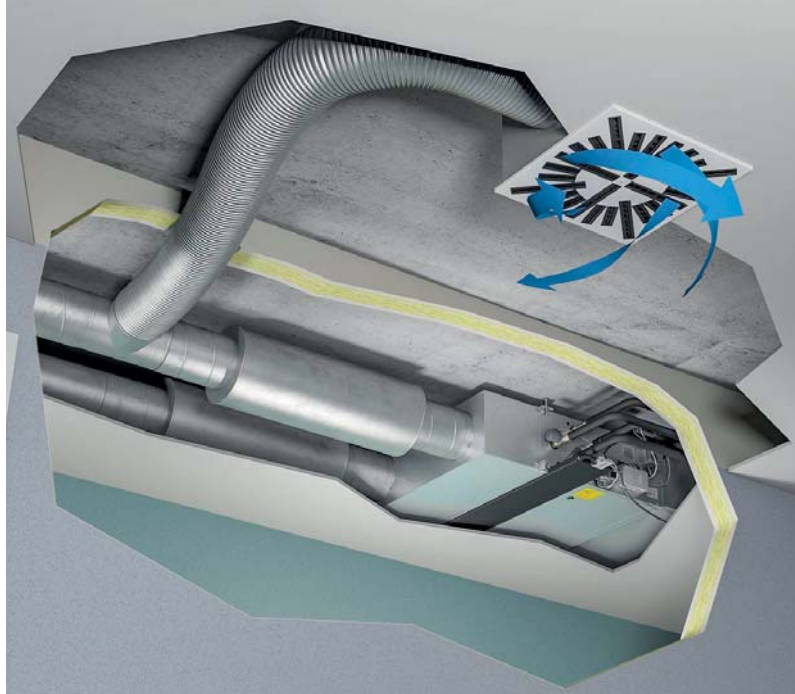

# Create space

Venkon

Only Kampmann provides you with fan coils that blend into the room but do not dominate it. In **suspended ceilings**, **hotel casings** or **sill-line casings**. Attractive, **free-standing casings** are of course also available.



# Diverse shapes and sizes

Venkon

## Four sizes

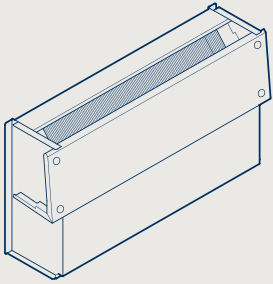

## Basic units

Size	Length	Height
61	625	494
63	925	494
66	1375	494
67	1725	494

## Models

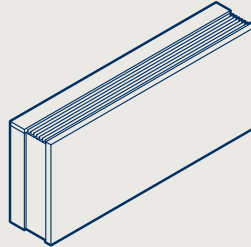

**Wall-hanging**  
Intake on the underside

Length	Height	Depth
900	505	235
1200	505	235
1650	505	235
2000	505	235

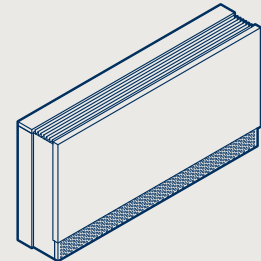

**Wall-mounted**  
Front intake

Length	Height	Depth
900	605	235
1200	605	235
1650	605	235
2000	605	235

## Installation options

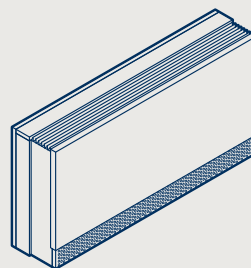
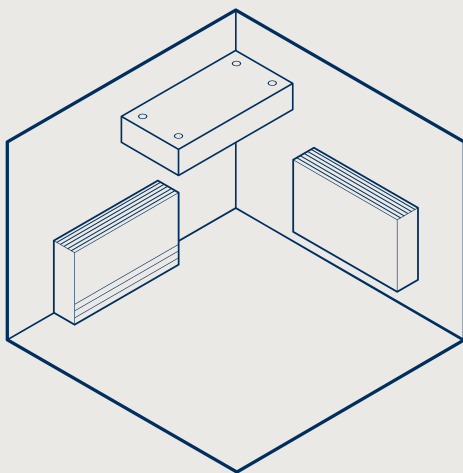

**Free-standing**  
Front intake, with rear panel

Length	Height	Depth
900	605	255
1200	605	255
1650	605	255
2000	605	255

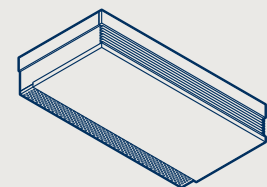

**Ceiling**  
Intake on the underside

Length	Height	Depth
900	605	235
1200	605	235
1650	605	235
2000	605	235

All dimensions in mm

# At your convenience

## KaCool D AF

Ceiling cassettes are the traditional method of air conditioning office buildings, hotels, showrooms and shop floors. And Kampmann KaCool D AF units have long been some of the leading products in this sector. The unit heats and cools rooms with its high output. Draught-free air flows are all the more important. The KaCool D AF is designed specifically for this. **The air discharge makes maximum use of the Coanda effect. It produces an air stream from the ceiling that falls into the room at a seriously reduced speed. That's what we call AtmosFeel (AF).** This technology is incorporated in all variants of the KaCool D AF. You can select either a model with a plastic or metal trim. If required, the valves can also be concealed within the housing, fully factory-fitted.



# Clinically clean

## KaCool D HC

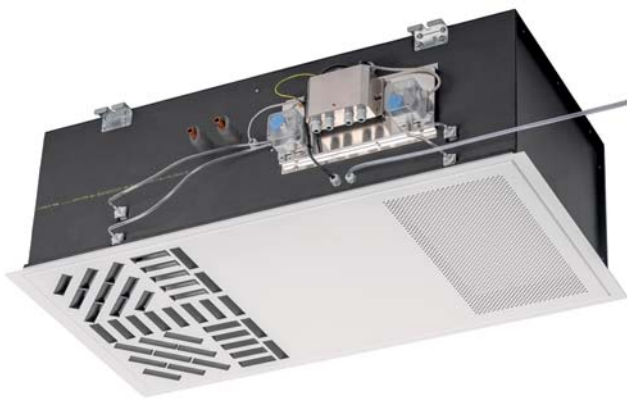

**First-class filter quality and a top cleaning concept make the KaCool D HC the perfect equipment to fit in doctors' surgeries and clinics.** It therefore complies with DIN 1946-4 for air handling units in healthcare buildings and premises, and accordingly is fitted with ePM1>55% and ePM1>85% filters in the air intake and outlet. Certified - but of course!

The entire interior space is fully and simply accessible. The complete underside of the ceiling-mounted device acts as a revision flap with snap-in closures. The coating on the interior space prevents corrosion and at the same time is also **resistant to cleaning with disinfectants.**

And to ensure that everything remains safe even between maintenance, the **built-in differential pressure sensor** signals the need to change the filter at an early stage. A Class H14 HEPA filter can also be used, for instance intermittently during the flu season.

# Everything under control

## KaDeck



Extremely easy to install and maintenance-friendly:

the KaDeck can be simply opened by concealed locks, while the waterside and electric connection areas are arranged in such a way that no further inspection openings are required on site.

**All components are easily accessible and maintenance could not be simpler. The KaDeck remains hygienically clean throughout its entire service life.**

## Primary air calculation

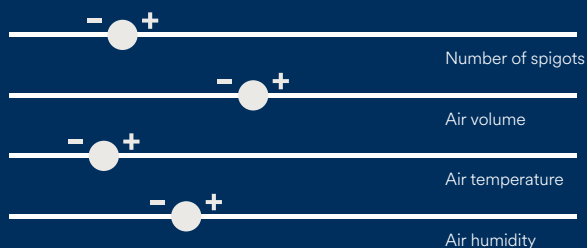

KaDeck introduces primary air into a space, with no additional supply air openings needed in the ceiling. **Conveniently calculate the primary air volume for your project on our website.** You'll find all you need to know there: primary air, heating and cooling outputs, as well as extensive technical data on sound levels and pipework in accordance with your selected control voltage. Then simply download your individual data sheet, bookmark the calculation or immediately send an enquiry about the product.

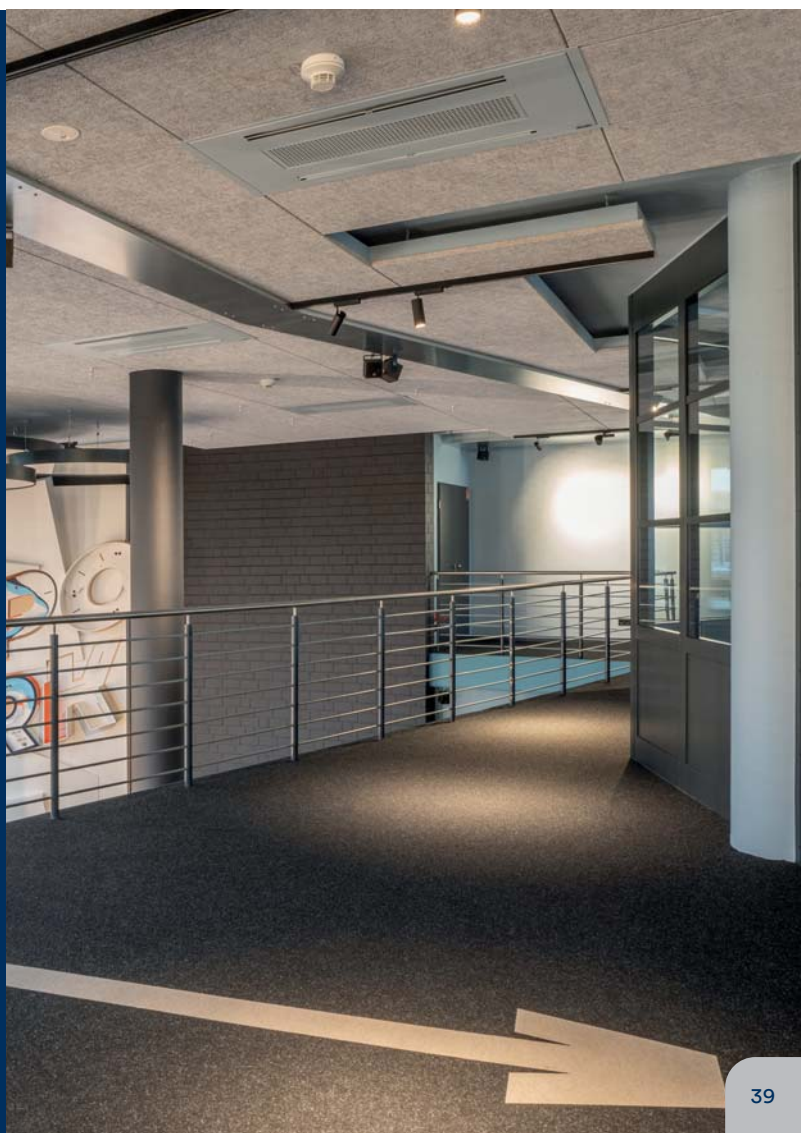

# It's your choice

## Venkon

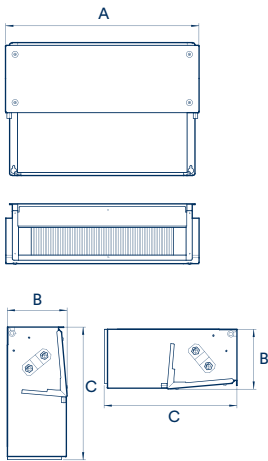

Version	Size	Length A [mm]	Depth B [mm]	Height C [mm]	Heat output <sup>1)</sup> [W]	Cooling output <sup>2)</sup> [W]
2-pipe	61	625	220	494	1851 – 8240	823 – 3339
	63	925	220	494	2856 – 12824	1133 – 5129
	66	1375	220	494	4540 – 20303	1864 – 8335
	67	1725	220	494	5447 – 26199	2184 – 10993
4-pipe	61	625	220	494	1567 – 5281	785 – 3150
	63	925	220	494	2399 – 8308	1029 – 4656
	66	1375	220	494	3668 – 12714	1556 – 6956
	67	1725	220	494	4496 – 16215	1909 – 9604

<sup>1)</sup> at LPHW 75/65 °C, t<sub>l1</sub> = 20 °C  
<sup>2)</sup> at CHW 7/12 °C, t<sub>l1</sub> = 27 °C, 48% rel. humidity

## Venkon XL

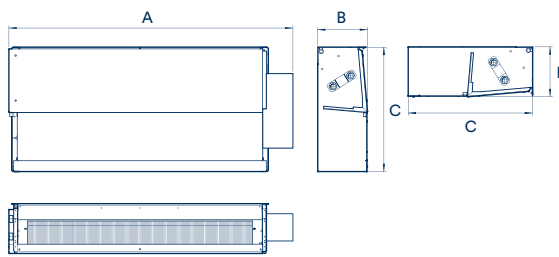

Filter class	Size	Control option		Length A		Air volume flow [m³/h]	2-pipe		4-pipe	
		electromech.	KaControl	Depth B [mm]	Height C [mm]		Heat output <sup>1)</sup> [W]	Cooling output <sup>2)</sup> [W]	Heat output <sup>1)</sup> [W]	Cooling output <sup>2)</sup> [W]
		[mm]	[mm]	[mm]	[mm]		[W]	[W]	[W]	[W]
Filter ePM10>50% (M5)	1	616	736	260	650	294 – 914	4230 – 13534	1861 – 5594	2743 – 8997	1625 – 4824
	2	916	1036	260	650	341 – 1577	5035 – 23429	2346 – 9701	3899 – 18433	2087 – 8401
	3	1366	1486	260	650	606 – 2460	8884 – 36590	4080 – 15176	6867 – 28801	3637 – 13200
	4	1716	1836	260	650	695 – 3161	10329 – 47452	4886 – 19702	7981 – 37166	4292 – 16967
Filter ePM1>50% (F7)	1	616	736	260	650	211 – 838	3101 – 12488	1421 – 5188	2033 – 8339	1254 – 4482
	2	916	1036	260	650	215 – 1373	3325 – 20587	1631 – 8599	2604 – 16277	1477 – 7469
	3	1366	1486	260	650	403 – 2171	6138 – 32567	2957 – 13614	4784 – 25748	2676 – 11874
	4	1716	1836	260	650	425 – 2710	6617 – 41091	3325 – 17245	5198 – 32368	2974 – 14895

<sup>1)</sup> at LPHW 75/65 °C, t<sub>l1</sub> = 20 °C  
<sup>2)</sup> at CHW 7/12 °C, t<sub>l1</sub> = 27 °C, 48 % rel. humidity



# KaDeck

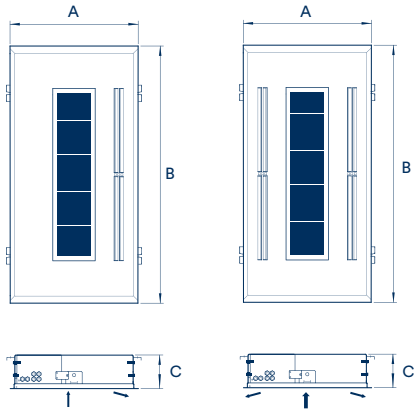

System	Air outlet	Width A	Length B	Height C	Cooling output (dry) <sup>1)</sup>	Cooling output (wet) <sup>2)</sup>	Heat output <sup>3)</sup>
		[mm]	[mm]	[mm]	[W]	[W]	[W]
2-pipe	one-sided discharge	600   625	1200   1250	165	134 – 752	346 – 1666	610 – 3247
	two-sided discharge	600   625	1200   1250	165	244 – 1364	641 – 3010	1113 – 5852
4-pipe	one-sided discharge	600   625	1200   1250	165	132 – 646	307 – 1348	468 – 1664
	two-sided discharge	600   625	1200   1250	165	243 – 1173	573 – 2442	868 – 3091

<sup>1)</sup> at CHW 16/18 °C, t<sub>l1</sub> = 27 °C, 48% rel. humidity  
<sup>2)</sup> at CHW 7/12 °C, t<sub>l1</sub> = 27 °C, 48% rel. humidity  
<sup>3)</sup> at LPHW 75/65 °C, t<sub>l1</sub> = 20 °C

# KaCool D AF

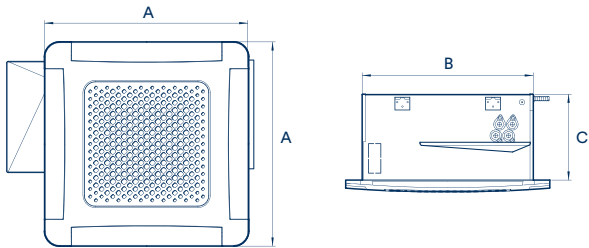

Version	Size	Panel length A	Carcass width B	Carcass height C	Cooling output <sup>1)</sup>	Heat output <sup>2)</sup>
		[mm]	[mm]	[mm]	[W]	[W]
2-pipe	1	680	572	286	1841 – 2829	4417 – 6614
	2	680	572	286	2324 – 4495	5251 – 9854
	3	680	572	286	2602 – 4972	5901 – 11307
	4	680	572	286	3947 – 5377	9549 – 12468
	5	930	818	326	3627 – 7039	8483 – 16511
	6	930	818	326	4328 – 9393	8966 – 20108
	7	930	818	326	5514 – 12078	12411 – 28539
4-pipe	1	680	572	286	1843 – 2623	3265 – 4554
	2	680	572	286	2014 – 3366	3606 – 6144
	3	680	572	286	1998 – 3964	2524 – 4331
	4	680	572	286	2523 – 4409	3014 – 4731
	5	930	818	326	3429 – 6186	6029 – 11224
	6	930	818	326	3915 – 7487	7256 – 13563
	7	930	818	326	4963 – 8454	9071 – 14602

<sup>1)</sup> at CHW 7/12 °C, t<sub>l1</sub> = 27 °C, 48% rel. humidity  
<sup>2)</sup> at LPHW 75/65 °C, t<sub>l1</sub> = 20 °C

# KaCool W

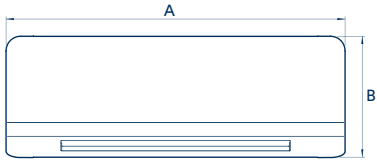

Size	Width A	Height B	Depth C	Cooling output <sup>1)</sup>	Heat output <sup>2)</sup>
	[mm]	[mm]	[mm]	[W]	[W]
1	930	333	185	1350 – 2300	1625 – 2775
2	930	333	185	1450 – 2400	1875 – 3000
3	1235	333	185	1775 – 3650	1725 – 4100
4	1235	333	185	1900 – 3800	1900 – 4400

<sup>1)</sup> at CHW 7/12 °C, t<sub>l1</sub> = 27 °C, 48% rel. humidity  
<sup>2)</sup> at LPHW 45/40 °C, t<sub>l1</sub> = 20 °C

# KaCool D HY

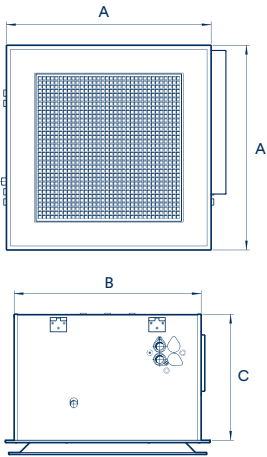

Version	Size	Length A	Width B	Height C	Cooling output <sup>1)</sup>	Heat output <sup>2)</sup>
		[mm]	[mm]	[mm]	[W]	[W]
2-pipe	1	623	575	385	1181 – 2690	2848 – 6170
	2	623	575	385	1388 – 4236	3132 – 9080
	3	623	575	385	1604 – 4703	3542 – 10429
	4	623	575	385	2321 – 5045	5917 – 11558
4-pipe	1	623	575	385	1129 – 2475	2012 – 4218
	2	623	575	385	1324 – 3211	2276 – 5712
	3	623	575	385	1198 – 3731	1654 – 4051
	4	623	575	385	1683 – 4220	2131 – 4478

<sup>1)</sup> at CHW 7/12 °C, t<sub>l1</sub> = 27 °C  
<sup>2)</sup> at LPHW 75/65 °C, t<sub>l1</sub> = 20 °C

# KaCool D HC

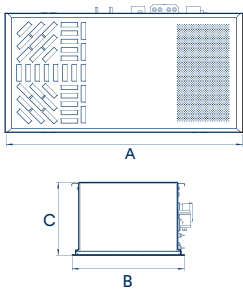

Version	Length A	Depth B	Height C	Heat output	Cooling output
	[mm]	[mm]	[mm]	[W]	[W]
2-pipe	1250	625 (675 <sup>1)</sup> )	406	470 – 6340	336 – 2923

<sup>1)</sup> including control



# Your digital product finder at [www.kampmanngroup.com](http://www.kampmanngroup.com)

Calculate your product online:  
[kampmanngroup.com](http://kampmanngroup.com) > Products > Fan Coils

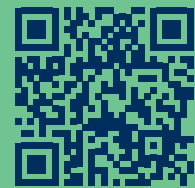

# Heat pump- based heaters

The cooling of buildings is becoming increasingly relevant. The typical products employed here include fan coils, which, as water-based systems, are as current and useful as never before. No wonder with all their benefits and versatile uses. Kampmann is at the forefront in different sectors.

- + cooling and heating in conjunction with heat pumps chillers
- + no refrigerant circulating in the building and only small quantities used in the chiller
- + fast response times thanks to powerful and efficient EC fans
- + for every requirement for installation in and under the ceiling, suspended on the wall or free-standing
- + in hybrid systems to supply primary air and control the temperature of the recirculating air
- + for air conditioning in addition to surface temperature control

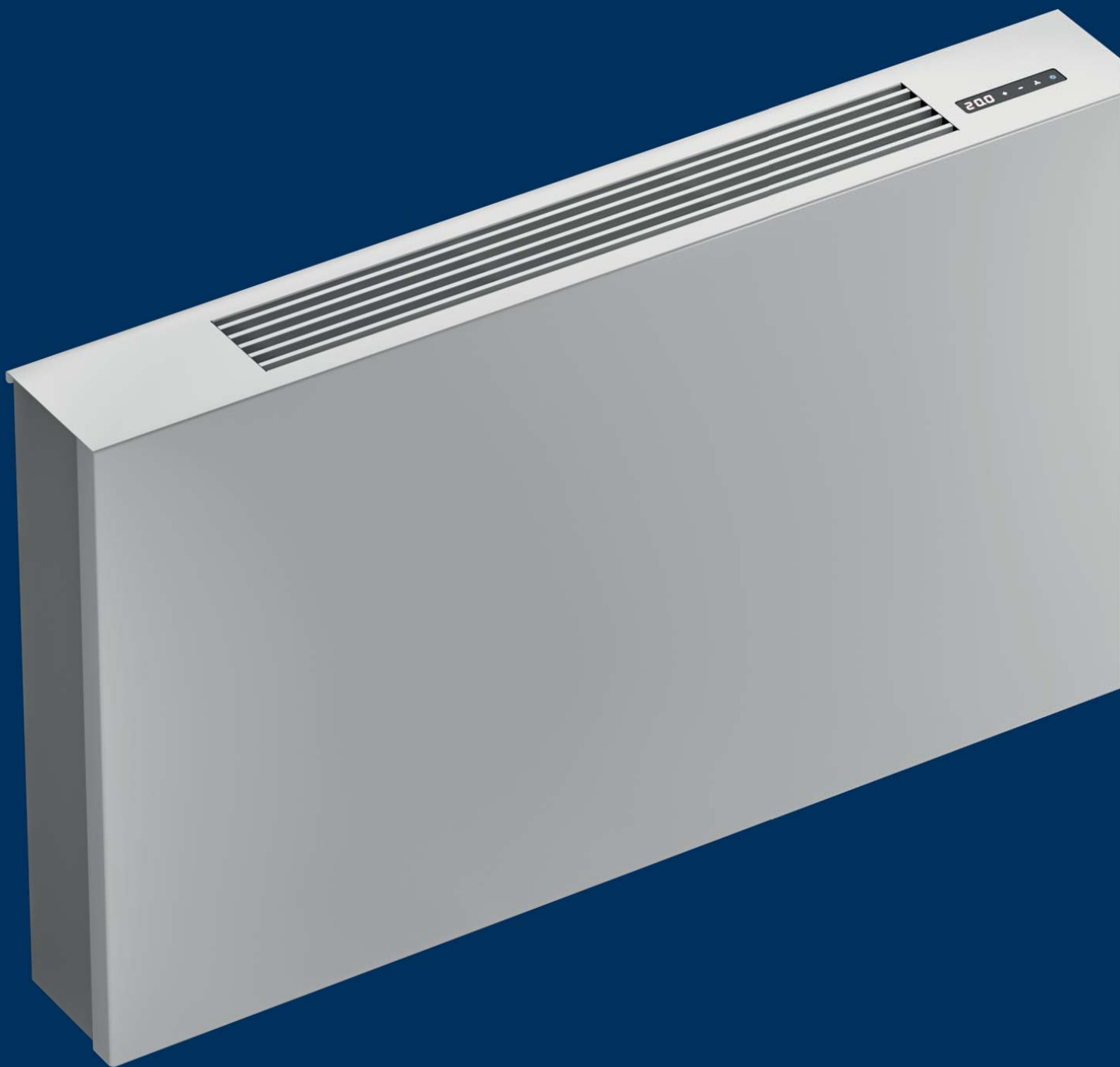

# The low-temperature heat pump system

In almost all heating systems, the temperature of the heating water is crucial for their efficient operation. The exact temperature of this water depends on the combination of heat generator and heat consumer selected. For instance, if a gas heating system is replaced by a heat pump the supply temperature can be lowered. Adding a heat pump-based heater enables ultra-low supply temperatures to simultaneously generate high outputs.

- + improved efficiency
- + energy requirement
- + lower heating costs
- + reduced greenhouse gas emissions



## The heat pump-based heater for the home

### PowerKon LT

The myth that a heat pump in your own home only works with underfloor heating is long out of date. Fan-assisted heaters, also known as heat pump-based heaters or low-temperature heaters, represent a convenient solution for use in the home.

PowerKon LT units are ideal for use in new buildings to fully benefit from the cooling function of the heat pump. However, they are also very popular, especially in existing homes.

The PowerKon LT makes it easy to switch from an oil or gas heating system to a heat pump.

And they can even have a cooling function, depending on the pipework and individual comfort requirements.

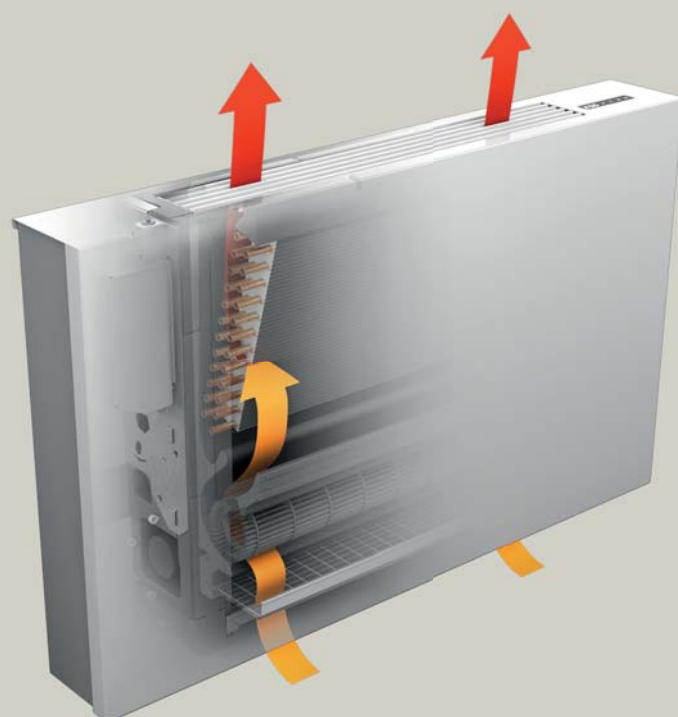



## Benefits of heat pump-based heaters

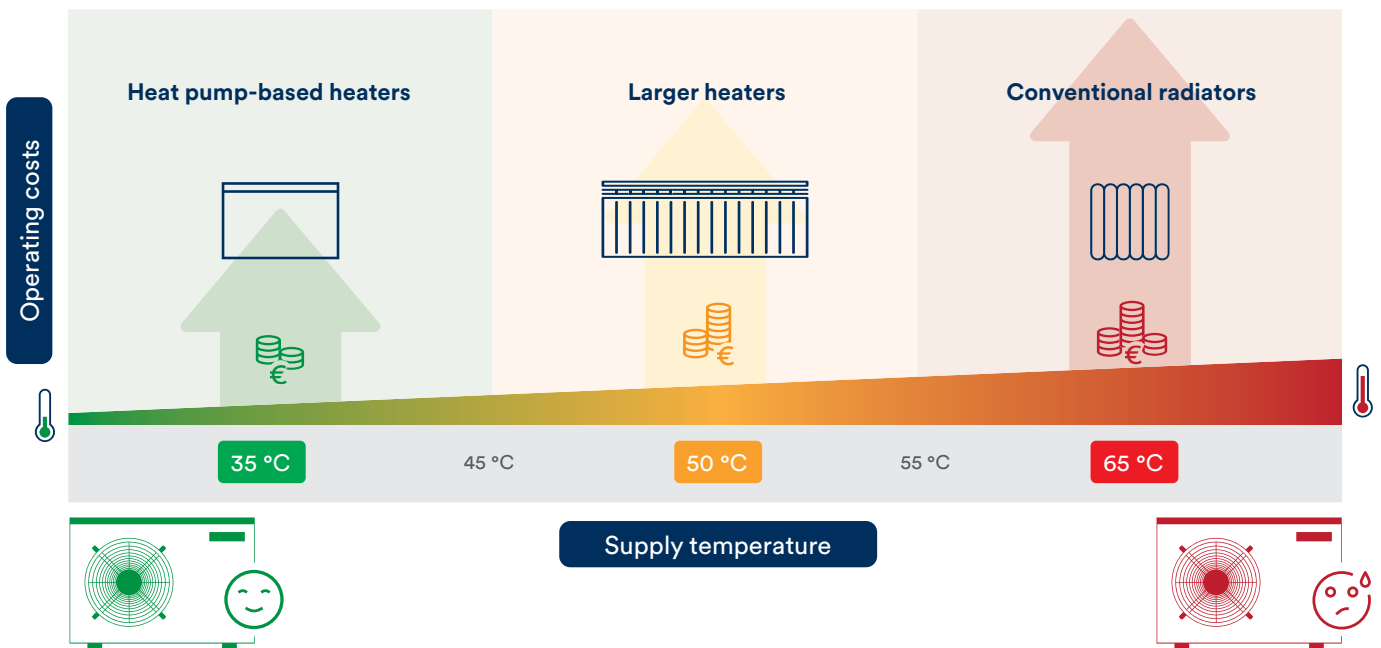

PowerKon LT units fully exploit the benefits of heat pumps: low supply temperatures of 35 °C. Admittedly, heat pumps are frequently capable of delivering higher temperatures, but this is inefficient! A 35 °C low temperature system with a PowerKon LT works around 25 – 35% more efficiently than a high-temperature system operating at 55 °C.

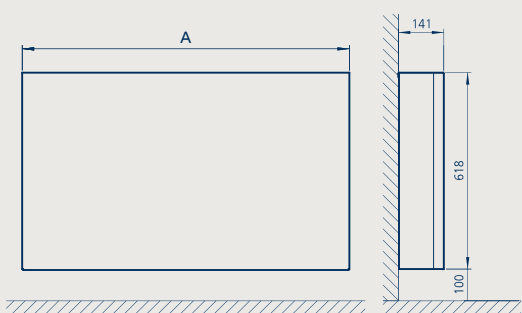

Length A	Height	Depth	Heat output <sup>1)</sup>	Heat output <sup>2)</sup>	Cooling output <sup>3)</sup>
[mm]	[mm]	[mm]	[W]	[W]	[W]
780	618	141	705 – 1355	355 – 685	535 – 1135
1030	618	141	990 – 2145	500 – 1080	765 – 1750
1220	618	141	1165 – 2715	585 – 1365	920 – 2185

<sup>1)</sup> at LPHW 45/40 °C,  $t_{L1} = 20$  °C

<sup>2)</sup> at LPHW 35/30 °C,  $t_{L1} = 20$  °C

<sup>3)</sup> at CHW 7/12 °C,  $t_{L1} = 27$  °C, 48% rel. humidity

# Air handling units

The benefits that we offer you as a system provider are particularly evident with our air handling units.

Starting with simple combinations of our air handling units with swirl diffusers, compact units either stand-alone or together with local units, such as unit heaters, to our sophisticated individualised solution incorporating all the rules of air handling artistry.

- + standard compact and shallow air handling units
- + freely planned air handling units individually configured
- + large selection of heat recovery systems
- + innovative Ka2O technology for indirect evaporation cooling
- + expertise in offices, retail, hotels, swimming pools, hospitals ...
- + hybrid systems consisting of a central air handling unit for ventilation and heat recovery combined with local units for temperature control





POWERS 8000  
K.A. S. 20000710400104  
A.S. MURGIOSI

**KAMPMAN**

# KaCompact KG

## Compact and versatile

The efficient heat recovery of the KaCompact KG ventilation unit is what sets it apart. It is achieved by integrated counterflow heat recovery and energy-efficient EC fans. Standard units guarantee fast delivery times and minimal need for training in terms of design, thanks to the freely available design tool, as well as installation and commissioning on site.



# ICA

## Control from A to Z

Our in-house control options offer a user-friendly interface for simple compact solutions through to complex special solutions. Their ease of use ensures the fast commissioning of the module.

Any other requirements? Remote system monitoring? Functional testing and instruction by Kampmann? Happy to help!

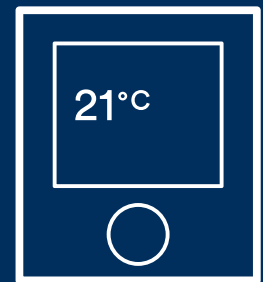

# Airblock FG

Shallow, modular system for heating, cooling, ventilation and filtering with heat recovery.

Combine supply air, extract air and heat recovery modules to suit your requirements.

Always as shallow as possible, partly due to flow grids with adjacent air routes and efficient EC fans.





# KaCompact

## Large spaces can breathe

The KaCompact ventilation unit was specifically designed to replace polluted room air with fresh outdoor air in large spaces, such as in **industrial premises, DIY stores, retail chains or workshops**, at the same time creating a pleasant climate.

The roof feed-through is located directly below the unit. The large rotary heat exchanger is positioned horizontally above this, minimising the dimensions of the KaCompact.

**Design a sophisticated hybrid system with unit heaters in the room.**

## Design tool

Kampmann offers comprehensive and intuitive design tools and project configuration aids for all products. All are freely available without the need to log in or register.

KaCompact KG units can be quickly and individually designed, thanks to their user-friendly and simple configuration.



# Ka<sub>2</sub>O

## Indirect evaporation cooling

Cooling buildings can also be sustainable – our Ka<sub>2</sub>O system for air handling units fully exploits the potential of indirect evaporation cooling. **With water used as the sole refrigerant.**

Water is sprayed into the heat exchanger on the extract air side. This ‘impregnation’ of the extract air cools it down so that heat is removed from the incoming outside air in a counterflow principle. The warm outside air also causes any deposits of water on the extract air side to evaporate, further cooling the outside air.

Small counterflow heat exchangers are used in the Ka<sub>2</sub>O system, which can be arranged in a modular way for the air volumes required. The major advantage of this: **Regardless of the volumetric flow, the pressure loss never exceeds 170 Pa.**

That’s ok: regardless of the outside air temperature, up to 24,000 m<sup>3</sup>/h of supply air are cooled to 0.5 K above the wet bulb temperature of the extract air.

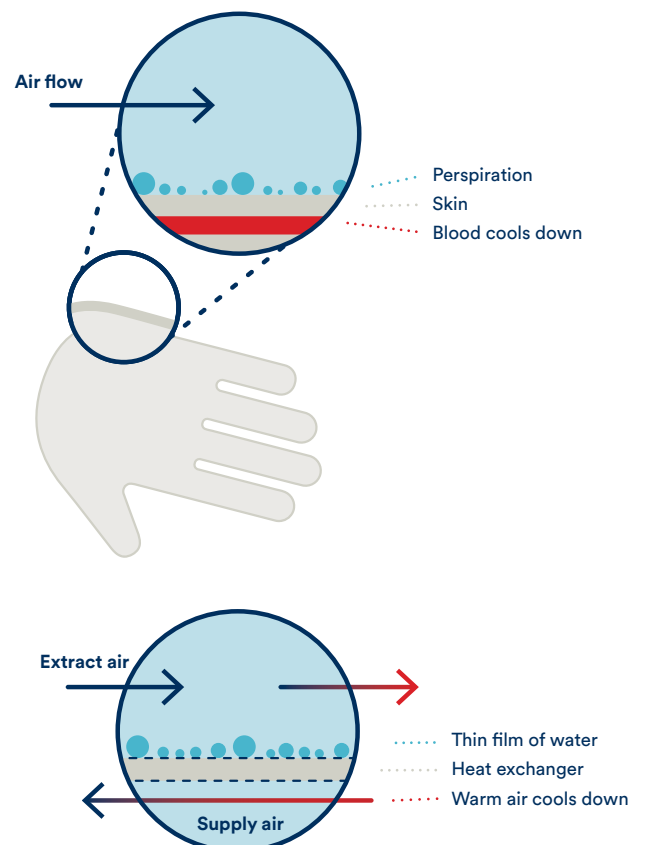

# Spoilt for choice

## Heat recovery

We consider the requirements of your project to determine the best heat recovery system to meet your needs. **Our NOVA brand engineers will help you to make the right choice.**

The air handling specialists will offer you heat recovery systems ranging from **rotation or counterflow heat exchangers**, double-plate heat exchangers to innovative **high-performance run-around coil systems (RCS) or Ka<sub>2</sub>O** counterflow modules with indirect evaporation cooling.

# Housing technology

## NOVA air handling units adapt to your building

More and more often, space (not) being available and tight installation spaces are key factors in equipment design. It's great that we are designing with Europe's smallest grid dimension: 93.33 mm. But small units are not intended to reduce comfort and performance. Leave that to us. Our in-house developed housing profile obviates the need for a base frame.

What does this mean? **Simple installation using sturdy individual cubes, which can also be inserted through small openings.** Incidentally: crane lugs are always a given. And another thing, our housing technology also guarantees lower sound power levels.

# Hygienic unit



Our air handling units are designed to conform to VDI 6022 and VDI 3803. The air entering a room may not be worse than the air being drawn off. This is, of course, a minimum target, which we far exceed for various requirements. We have extensive experience with hospital and clean room air conditioning, for which DIN 1946-4 sets the standard. With special HEPA filtration specifications, separate air routes and airtightness, temperature and humidity. Get in touch with us. We can do it.

# Integrated cooling generation

Traditionally cooling has been provided by an externally mounted chiller or a heat pump. But it can also be built into the air handling unit. The advantage of integrating the chiller components results in an extremely compact design, a high degree of operational reliability due to low content with short pipe runs and excellent energy efficiency thanks to low distribution and downtime losses. Up to what level? Over 500 kW are possible with interconnected circuits.

# Our air handling units at a glance



## KaCompact KG

- > compact ventilation unit with heat recovery
- > standard range with fast delivery times
- > freely accessible design program for fast project configuration



## KaCompact

- > for combined centralised ventilation with local temperature control
- > continuously variable energy-saving EC radial fans
- > complies with the requirements of the Ecodesign Directive (ERP) 2018



## Airblock FG

- > for heat recovery, fresh air, mixed air, recirculating air, heating or cooling mode
- > high output combined with a shallow design
- > shallow height and compact design for when space is at a premium: hence versatile installation options



## Individual air handling units

- > various systems for heat recovery, cooling, humidification/dehumidification etc.
- > precisely tailored air volumes
- > sustainable, innovative systems, e.g. Ka<sub>2</sub>O

## Air outputs

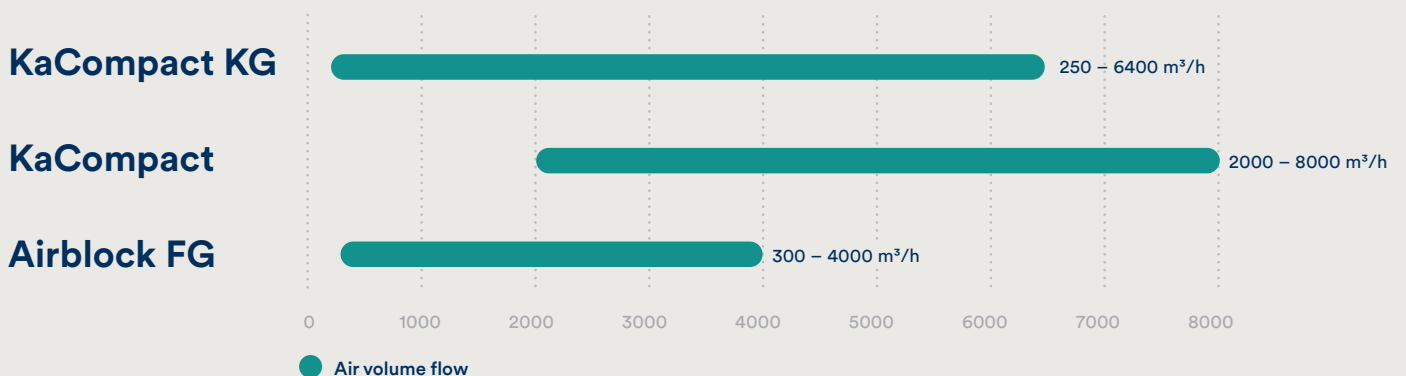

# Real team players

## Hybrid ventilation concept

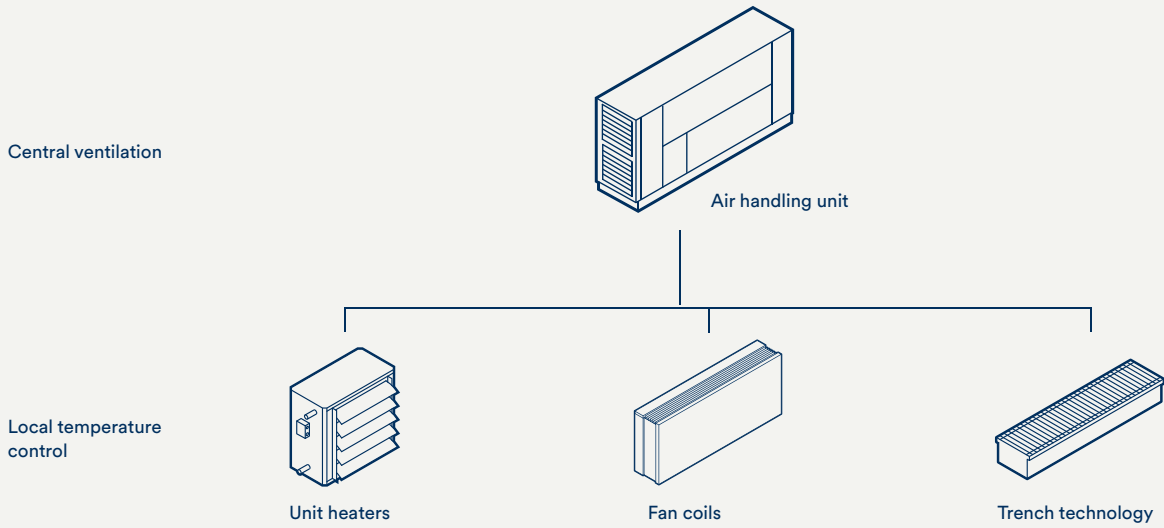

Hybrid ventilation systems are **bidirectional ventilation systems with efficient heat recovery.**

**Temperature control is provided by local units** inside the room and not by the central ventilation unit (air handling unit). Primary air is only fed in if required. A CO<sub>2</sub> sensor monitors this specific requirement. Otherwise, the local units are operated with secondary air.

**Hybrid ventilation systems make sense, as the use of water as a carrier medium is more efficient than air.**

Our unit heaters are ideal for this in conjunction with our KaCompact range of units or individually configured air handling units.

## One-stop air handling units and diffusers

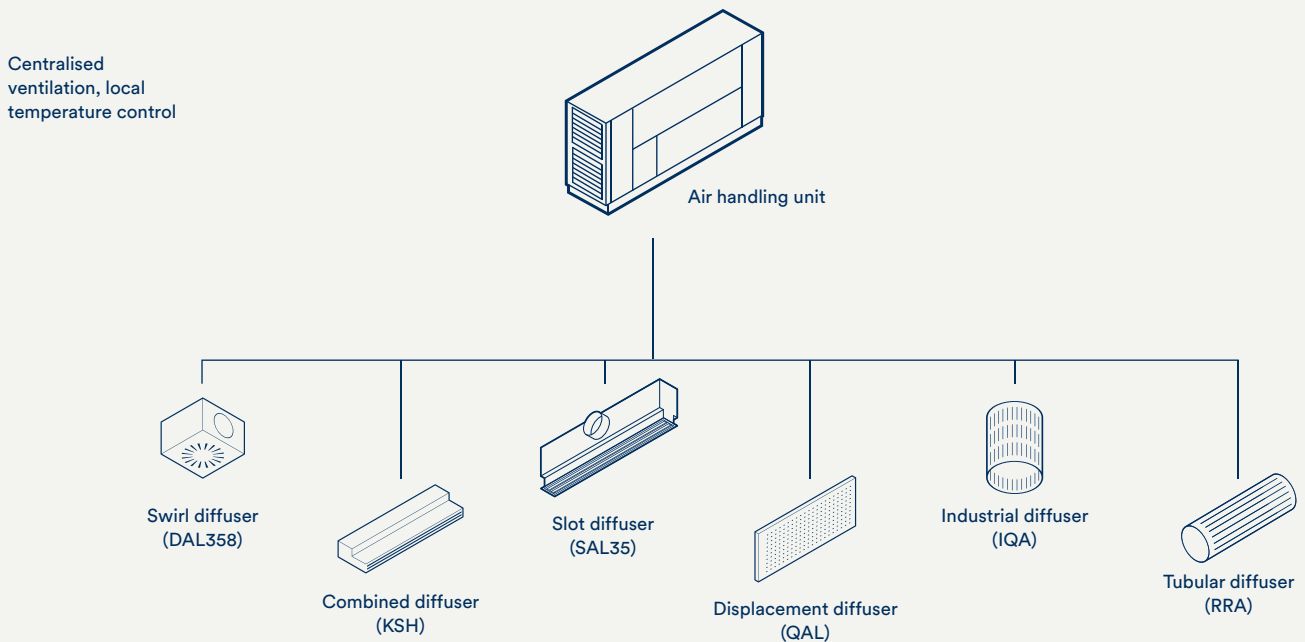

# It's your choice

## KaCompact KG

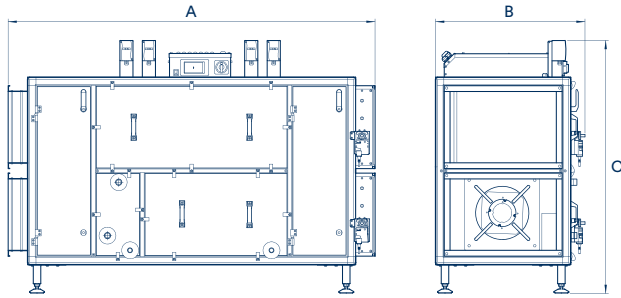

Size	Length A [mm]	Width B [mm]	Height C [mm]	Air volume <sup>1)</sup> [m³/h]	Heat recovery coefficient <sup>2)</sup> [%]	Heat recovery output <sup>2)</sup> [kW]	Heat recovery coefficient <sup>3)</sup> [%]	Heat recovery output <sup>3)</sup> [kW]
15	1958	797	1348	250 – 1450	83.9 – 75.5	1.4 – 7.7	90.2 – 81.4	2.4 – 13.7
25	2507	797	1720	540 – 2800	81.2 – 73.6	2.9 – 13.7	87.8 – 79.7	5.1 – 24.4
40	2908	944	2094	800 – 4500	85.6 – 77.5	4.5 – 23.3	92.3 – 83.9	7.9 – 41.2
60	3008	1215	2094	1200 – 6400	85.5 – 78.0	6.8 – 33.4	92.0 – 84.3	11.9 – 58.8

<sup>1)</sup> all values with an external pressure of 300 Pa at a nominal air volume flow and clean filters

<sup>2)</sup> according to DIN EN 308

<sup>3)</sup> at outside air = -12 °C, 90%, extract air = 20 °C, 40%

## KaCompact

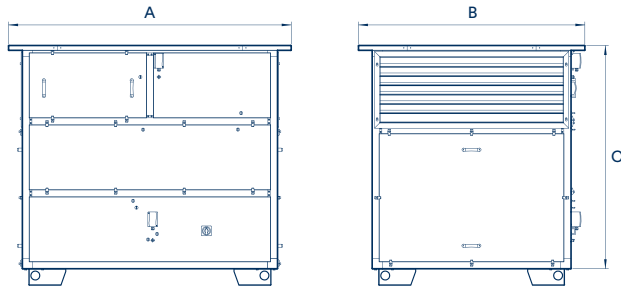

Size	Length A [mm]	Width B [mm]	Height C [mm]	Air volume <sup>1)</sup> [m³/h]	Heat recovery coefficient <sup>2)</sup> [%]	Heat recovery output <sup>2)</sup> [kW]	Heat recovery coefficient <sup>3)</sup> [%]	Heat recovery output <sup>3)</sup> [kW]
5000	1860	1450	1645	2000 – 5500	74 – 82	10.7 – 27.7	74 – 82	22.2 – 56.2
8000	2060	1800	1945	3000 – 8000	75 – 82	18.8 – 40.8	75 – 82	39.0 – 82.9

<sup>1)</sup> all values with an external pressure of 50 Pa per air route with nominal volumetric flow, clean filters and a rotor speed of 10 rpm (equates to a rotor setting of 10 V)

<sup>2)</sup> according to DIN EN 308

<sup>3)</sup> at  $t_{OUTS} = -12$  °C, 90% rel. humidity,  $t_{EXH} = 20$  °C, 40% relative humidity

## Airblock FG Supply air module

Size	Length A [mm]	Height B [mm]	Depth C [mm]	Air volume flow [m³/h]	Heat output <sup>3)</sup> [kW]	Outlet air temperature <sup>3)</sup> [°C]
6	1000	390	740	300 – 1100 <sup>1)</sup>	4.1 – 10.4	48.1 – 60.5
7	1000	390	940	700 – 2000 <sup>1)</sup>	8.3 – 16.9	45.2 – 55.2
8	1100	490	940	800 – 2800 <sup>2)</sup>	10.0 – 23.7	45.1 – 57.0
9	1100	490	1140	1300 – 4000 <sup>2)</sup>	15.3 – 32.7	44.3 – 55.1

<sup>1)</sup> with 100 Pa external pressure including LPHW heat exchanger and ISO ePM2.5 65% filter as per ISO 16890

<sup>2)</sup> with 150 Pa external pressure including LPHW heat exchanger and ISO ePM2.5 65% filter as per ISO 16890

<sup>3)</sup> at LPHW 75/65 °C,  $t_{L1} = 20$  °C





# Your digital product finder at [www.kampmanngroup.com](http://www.kampmanngroup.com)

Calculate your product online:  
[kampmanngroup.com](http://kampmanngroup.com) > Products > Air handling units

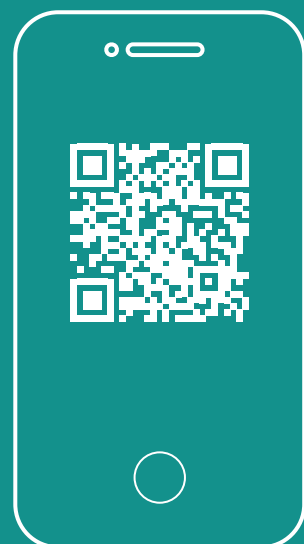

# Diffusers

Discreetly integrated into walls and ceilings or installed prominently as a statement feature. The possibilities are manifold with our wide range of diffusers for the comfort and industrial sector.

We will swirl, displace and mix until we find the perfect system for your project.

- + It's got character. Diffusers with the patented eccentric roller for project-based air outlet characteristics.
- + No compromise between large air volumes and comfort with swirl and slot diffusers.
- + Enjoy the benefits of dry walling with combined diffusers.  
And supply air, extract air and sound insulation in one.
- + Call it a loft feature or industrial charm – tubular diffusers are truly eye-catching.  
And hydraulic balancing? That's our job!



# At your convenience

The required air volumes need to be fed into rooms with no draughts. **Benefit from our planning and design expertise alongside our market-leading products.** Together with you, we will take into account key influencing factors and physical principles to obtain a comfortable air intake: temperature and induction ratios, Coanda effect, and the critical air stream path. We are always there to help.

## Displacement air

Fresh and unobtrusive

Displacement ventilation is the art of cooling a room by introducing primary air at a low pulse rate with only minimal undertemperature. When it's done well, it's as simple as it is brilliant.

**It produces a pleasant pool of fresh air. Heat sources, such as human bodies or machines, cause the air to rise from this pool and dissipate heat loads.** Up to 50 W/m<sup>2</sup>. Our displacement air units can also be combined wonderfully with other systems, such as chilled ceilings.

## Tubular pipe system

To be honest: not everyone can do this.

Tubular pipe systems are totally on-trend and we are complete fans of them. Architects and users love their unique industrial charm in occupied zones. We look after the hydraulics. After all, it's not straightforward. **Over longer sections, the air from each section of pipe needs to be fed into the room evenly. Each outlet is set appropriately for this purpose.** It's a good thing that we don't leave anything to chance with our calculation software.



Control of the air flow direction

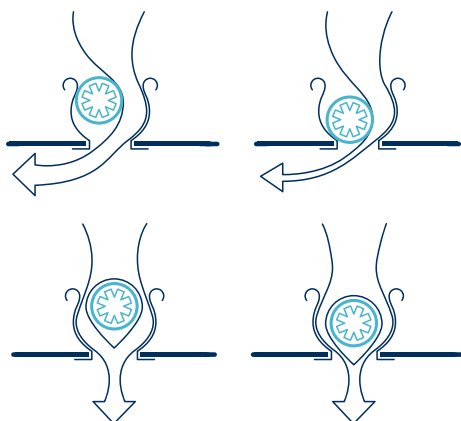
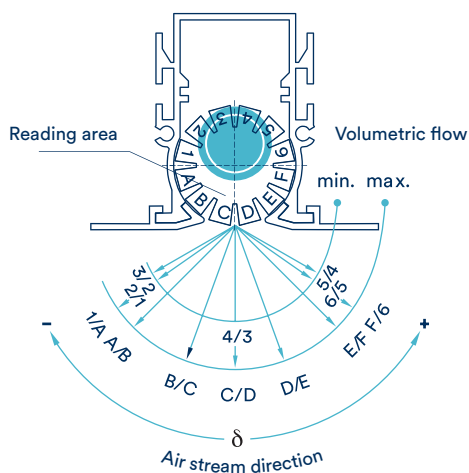

## Our patented heart

### Eccentric roller

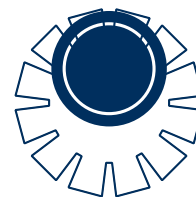

Many of our diffusers feature an eccentrically-borne roller, which **determines the air discharge characteristics depending on its position**. In summary, it makes our products very versatile for all requirements by influencing the air flow direction, the volumetric flow and the induction percentage. **At the design stage, the optimum calculated roller position is determined for each air outlet.** Have there been structural changes? All good! The eccentric roller can be adjusted at any time in situ.

# Our diffusers at a glance

## Swirl diffusers



Products with built-in eccentric roller

Swirl diffusers are the undisputed champions when it comes to feeding **high volumetric flows into occupied zones** of all kinds. They are the only products capable of meeting the most exacting comfort standards at the same time as dissipating high thermal loads. This is made possible by the highly inductive Coanda ceiling air stream that rapidly mixes with the room air.



DAL358



- > eccentric roller for optimum factory air flow setting, adjustable in situ
- > monodirectional, bidirectional or rotating ceiling air stream
- > square ceiling grid dimensions or round front plate



DRS

- > rigid fins, 45° position



DAL359



- > integral air guidance elements for individual air stream patterns
- > square ceiling grid or round front plate

# Tubular diffusers

With high-grade industrial-quality charm, tubular diffusers provide thermal comfort in occupied zones by means of clearly defined discharged air volumes.



## RRA

- > total system features hydraulic volumetric flow compensation
- > precise air outlet positioning
- > also available as an oval diffuser (ORA)



# Slot diffusers

Precise air flow paths for the comfortable supply of air. For applications with temporarily cooled or heated air, and also featuring motorised adjustment of the discharge characteristics.



## SAL 35



- > ceiling diffuser
- > 35 mm profile width
- > eccentric roller



## SAL 50



- > ceiling diffuser
- > 50 mm profile width
- > eccentric roller

## SDA

- > floor diffuser
- > load-bearing
- > visible width 38/59 mm (one-/two-row)



# Ceiling diffusers

Distinguished ceilings demand the very best diffusers, whether in the form of inductive ceiling air streams or as a concealed outlet behind perforated chilled ceilings.



## DIA

- > inductive ceiling air stream
- > square ceiling grid dimensions or round front plate

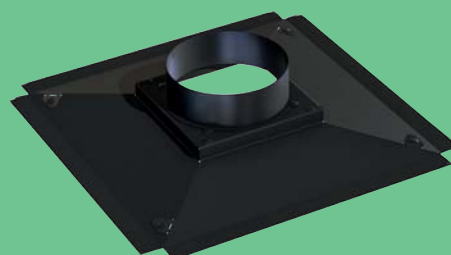

## MDA

- > diffuser for metal chilled ceilings
- > concealed behind perforated metal chilled ceilings
- > radial ceiling air stream



# Combined diffusers

The **continuous slot appearance of supply air and extract air units** is just as popular as its maintenance and cleaning concept. All combined diffusers are fitted with sound insulation backing. Despite being connected to the corridor ceiling, discussions within the office remain confidential.

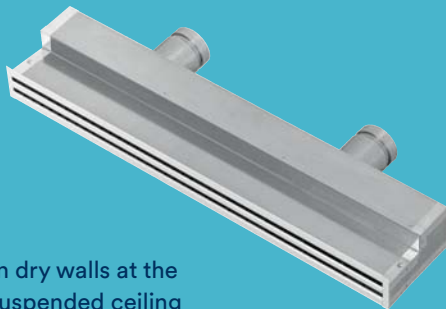

**KSH**  
> installation in dry walls at the height of a suspended ceiling



**KS**  
> installation in ceiling recesses

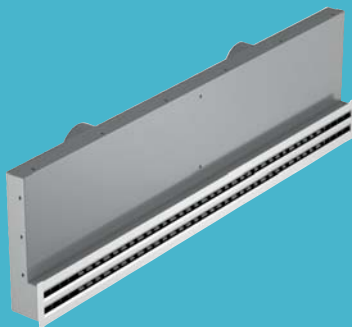

**KSW**  
> installation in dry walls below a suspended ceiling

# Grilles

As inconspicuous as they are, they nonetheless have a **massive influence on the comfortable and energy-efficient supply of air**. The decisive factor here is the control and spread of the air stream produced by the grille fins.

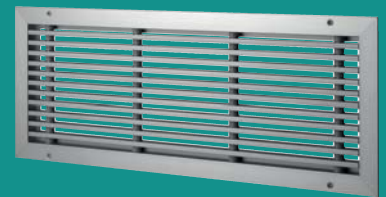

**G341**  
> supply air and extract air grille  
> fixed fins

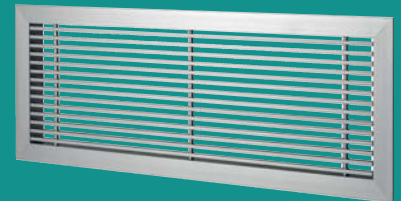

**G328**  
> supply air and extract air grille  
> fixed fins  
> ball impact-proof

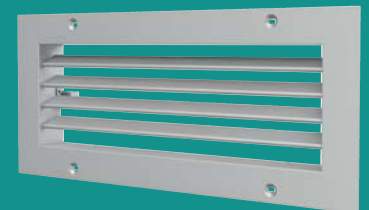

**G311**  
> supply air and extract air grille  
> variable fins

# Wide-angle nozzles

Jet nozzles are ideal wherever high air volumes are required. They are ideal for installation in series or as a battery.



**WWD**  
> rotatable  
> pivotable  
> highly inductive

# Industrial diffusers

Any heat produced in halls is dissipated by stratification ventilation. And large penetration depths are needed for heating. The requirements are diverse. So is our product range.

## IVA

- > displacement air diffuser in the shape of a column
- > air stream direction can be varied depending on whether heating or cooling

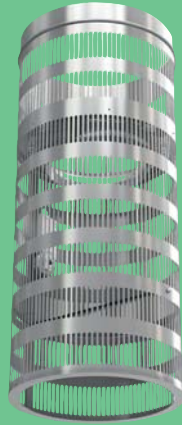

## IQA

- > displacement air diffuser in the shape of a column
- > air stream direction can be varied depending on whether heating or cooling

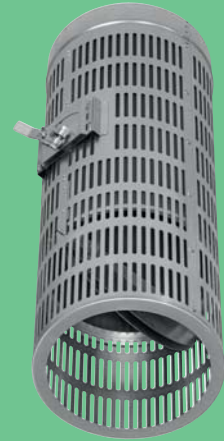

## LDA

- > displacement air diffuser
- > swirl diffuser for variable penetration depths of 3 to 18 m



## LDI

- > swirl diffuser
- > swirl blades for variable penetration depths of 3 to 32 m
- > large air volumes of up to 12,000 m<sup>3</sup>/h

# Floor diffuser

The LBQ displacement air diffuser creates a lake of fresh air, which is perceived as very pleasant and comfortable by the occupants of the room. The integrated perforated plates below the grille create a low-pulse and even inflow of supply air into the occupied zone.

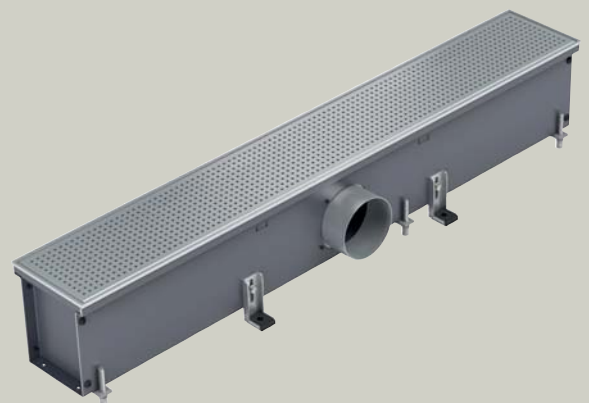

## LBQ

- > for raised floors
- > perforated panel, roll-up or linear grille cover
- > round or oval spigots



# Displacement diffusers

Fed in at very low speed, displacement air diffusers produce silent air conditioning that cannot be felt and efficiently uses natural thermal processes.

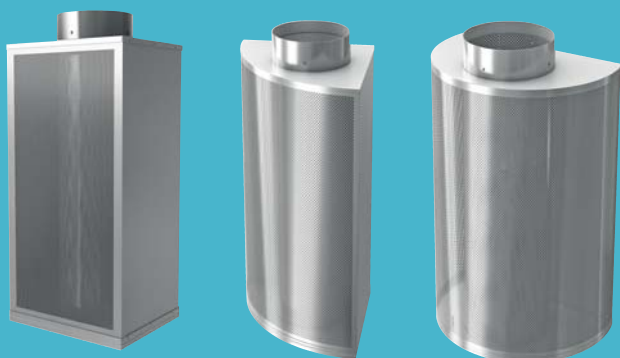

## QAL

- > displacement air diffusers with plenum box
- > linear version
- > round version (180°, 90°)

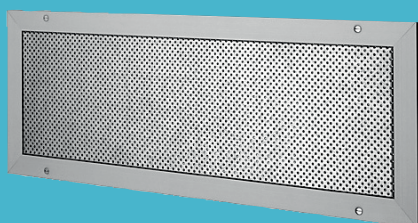

## QAL-K

- > displacement air diffusers directly attached to the air duct

# Overflow element

Extract air can be removed centrally in the corridor suspended ceiling or in adjacent rooms.

Overflow elements are used to discharge the extract air flows from several rooms.



## USE

- > installed in dry walls
- > low pressure loss
- > sound barrier

## Your digital product finder at [www.kampmanngroup.com](http://www.kampmanngroup.com)

Calculate your product online:  
[kampmanngroup.com](http://kampmanngroup.com) > Products > Diffusers



# Project support

Venkon + diffuser

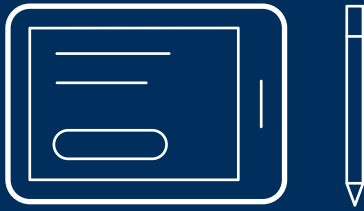

Many of our partners appreciate the wide range of options we offer as a system provider. Our **fan coil and diffuser combinations** are becoming increasingly popular. **Venkon or Venkon XL** units provide convenient solutions with **SAL slot diffusers**. We will gladly take on the individual design of your project. You can rely on the optimum combination of all factors, such as air volumes and pressure losses.



## Structural acoustics

We measure and optimise our products in a laboratory covering 2,000 m<sup>2</sup> to achieve the best solutions for you. **That applies to our standard product range and also to your customised product solution.** Let's consider the issue of structural acoustics. We analyse the acoustic properties of wall-mounted units in our reverberation laboratory with transmitter and receiver room. Get in touch with us about your next project. Whether you are looking for ventilation units, overflow elements or combined diffusers.

## Real team players

### Hybrid ventilation concept

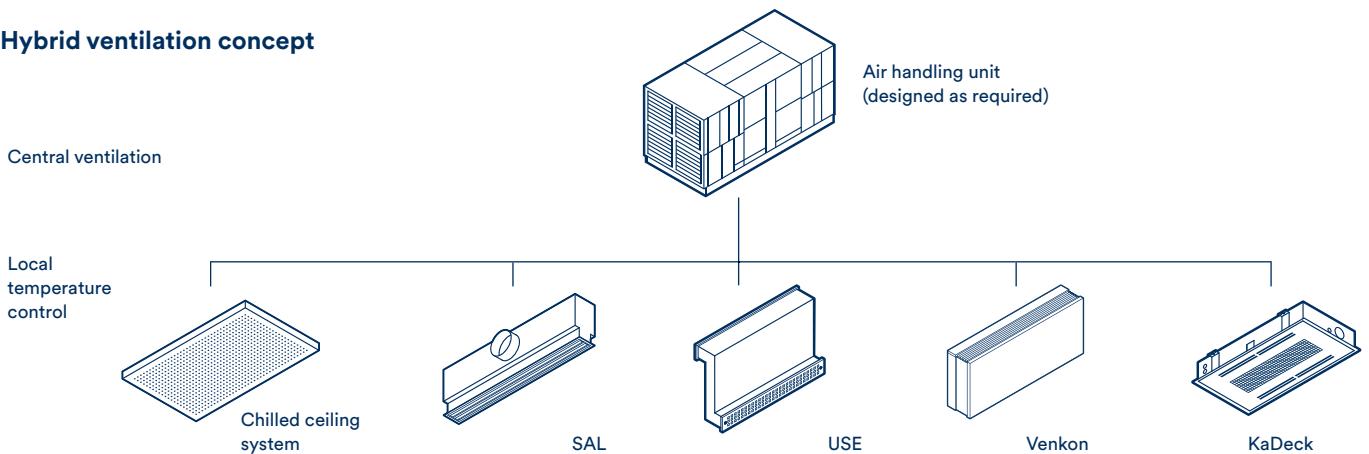

Individually designed air conditioning systems are realised by our NOVA-brand ventilation specialists, without the use of refrigerant and with adiabatic evaporation cooling. Of course, the combination with our diffusers is obvious. But you get so much more from this one-stop shop. **A system in which the primary air from the air handling unit is fed in through slot diffusers precisely incorporated in a chilled ceiling is ideal for occupied zones.** The extract air is discharged with overflow elements into adjacent corridor ceilings and is extracted centrally. In the room, fan coils, such as Venkon or KaDeck units, meet the residual heat requirements. Just one example of our countless system solutions. Let's discuss your project.

# Door air curtains

Kampmann door air curtains provide optimum screening of air conditioned doorways. They reliably perform wherever the indoor and outdoor climate meet directly.

- + minimal energy losses by screening cold outside air in winter
- + use of accumulated heat from the ceiling area to screen air
- + versatile use in retail outlets of all kinds, malls and public buildings
- + in summer they aid air conditioning systems when operated without heat, reducing the ingress of warm outside air, saving on cooling output and energy costs
- + fewer draughts: workstations can be arranged closer to the entrance area, maximising the use of the floor space

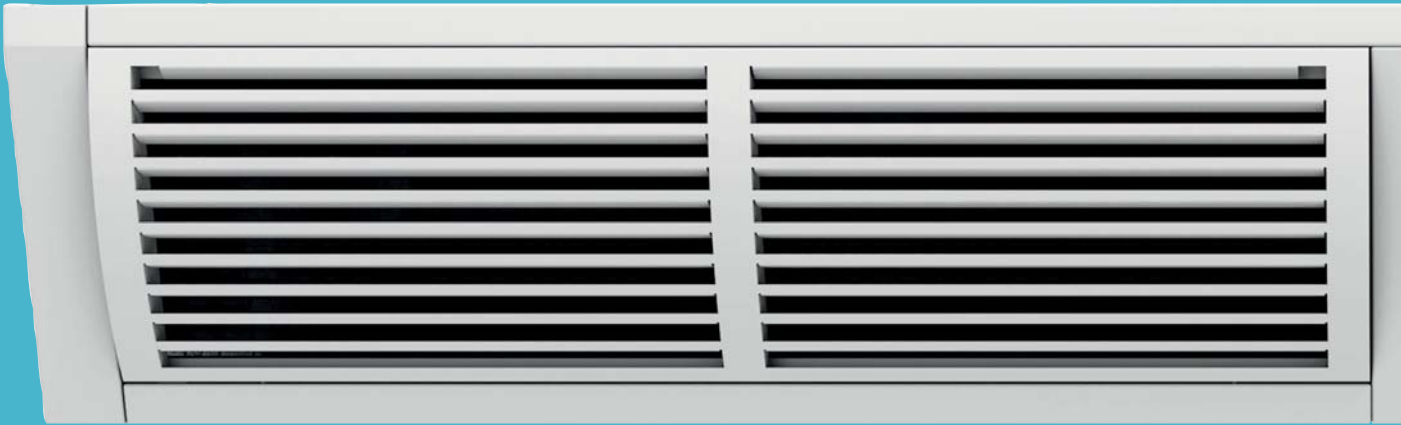

# Comfortable indoor climate with open doors

Open doorways are often simply necessary in the industrial sector. They aid the successful presentation of products in DIY stores and builder's merchants as well as shopping centres. Door air curtains are the product of choice to achieve this.

## Visibly invisible



Opt for either our UniLine or Tandem door air curtains. **Visible below the ceiling or subtly recessed.** The air outlet and inlet are located on the underside of cassette UniLine or Tandem ceiling-mounted units.

## Patented ambient and warm air curtain

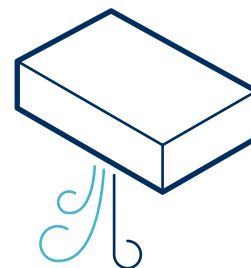

Tandem and ProtecTor each produce two air curtains. **An unheated air curtain on the door side and a warm air curtain on the room side.** The ambient air curtain with its greater penetration depth pulls the warm air curtain down with it. **Air turbulence with the cold outside air occurs primarily with the ambient air curtain.**



# Step this way

One small step and your customers will find themselves in a pleasant sales environment. Open doors lower customers' inhibition to enter a shop. And **the air screening effect enhances comfort in the entrance area**. Air curtains can also be used in malls and public buildings in a variety of ways.



## Space gain at the doorway

Door air curtains contribute to improved comfort in doorways and loading areas. **Therefore, even with a shed-like layout, workplaces can be located closer to the doorway.** The same applies, of course, to the till area of retail stores.



## Basic stage with the door closed

In applications where the doors are only closed for short periods of time, continuous operation at a basic load state makes sense even with closed doors. For comfort and efficiency. This is the only way to produce an adequate curtain of air as soon as the doors open. And, of course, we'll provide intelligent control as well.

# Our door air curtains at a glance



## Under-ceiling units



### UniLine

- > for the controlled screening of cold air with open doors
- > Silent AutoMotion: the self-regulating discharge flap increases the penetration depth of the air stream, particularly at lower fan stages
- > air screening reduces energy losses and increases comfort in the entrance area



### Tandem

- > for the controlled screening of cold air with open doors
- > officially verified property right: European Patent EP 1462730
- > up to 38% energy savings through the patented separation of ambient and warm air streams (Tandem technology)

## Ceiling cassette units



### Cassette UniLine

- > for the controlled screening of cold air with open doors
- > Silent AutoMotion: the self-regulating discharge flap increases the penetration depth of the air stream, particularly at lower fan stages
- > air screening reduces energy losses and increases comfort in the entrance area



### Tandem ceiling-mounted device

- > for the controlled screening of cold air with open doors
- > officially verified property right: European Patent EP 1462730
- > up to 38% energy savings through the patented separation of ambient and warm air streams (Tandem technology)

## Door screening



### ProtectTor

- > up to 38% energy savings through the patented separation of ambient and warm air streams
- > Coanda effect between the ambient and warm air streams
- > self-optimising back-up air stream when the fan speed changes

# Air volumes

## UniLine

290 – 5330 m<sup>3</sup>/h

## Tandem 300/365

700 – 8480 m<sup>3</sup>/h

## Cassette UniLine

290 – 4000 m<sup>3</sup>/h

## Tandem ceiling-mounted device

700 – 5810 m<sup>3</sup>/h

## ProtectoR

940 – 44190 m<sup>3</sup>/h

0 1000 2000 3000 4000 5000 6000 7000 8000 9000 10000

● Air volume flow

# Fits every time

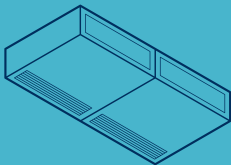

## UniLine

Height 250

Depth 550

Length 1000 | 1500 | 2000 | 2500 | 3000

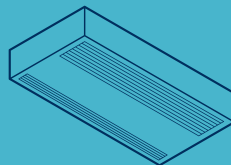

## Cassette UniLine

Height 265

Depth 600 | 625

Length 1000 | 1500 | 2000 | 2500

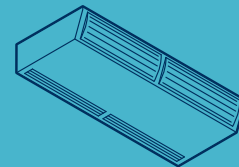

## Tandem 300

Height 300

Depth 820

Length 1250 | 2000 | 2500 | 3000

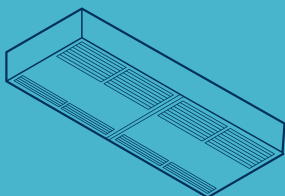

## Tandem in-ceiling unit

Height 300

Depth 800

Length 1200 | 1950 | 2450 | 2950

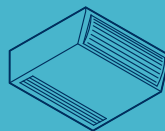

## Tandem 365

Height 365

Depth 985

Length 1250 | 2000 | 2750

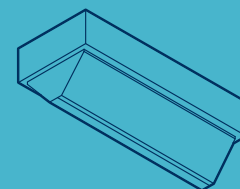

## ProtectoR

Height 360

Depth 740 | 840

Length 2000 | 3000 | 4000 | 5000

Dimensions in mm

# The in-house technician's friend



The maintenance concept for our UniLine is unrivalled. Make your in-house technician your friend: the large filter, including frame and intake grille, can be removed with ease. And what's more, **the entire base of the unit doubles as an inspection flap**. Naturally, perfectly secured.



# Whichever way you look at it

ProtecTor

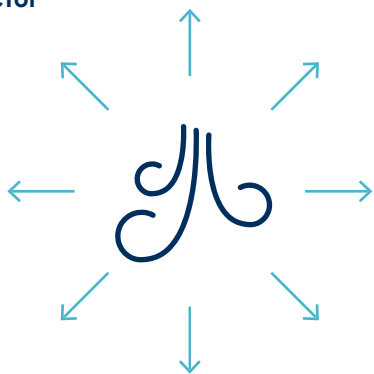

Depending on the type of doorway (roller gate, vertical sectional gate, horizontal sectional gate) and the arrangement of workstations, **ProtecTor door air curtains can be designed with horizontal or vertical units with different nozzle geometries**. The aim is to position the air discharge opening as close as possible to the doorway for efficient screening.

# Continuously variable control

EC technology

Of course, our built-in EC fans can be continuously variably controlled. **For efficient operation and only the noise emissions that are really necessary.** Perfectly controlled by our compact controller or in the Kampmann KaControl system. **Or integrated into the building management system?** But of course. We'll take care of the interface.

# SAM

## UniLine

SAM stands for Silent AutoMotion. In our UniLine EC door air curtains, the technology ensures an even air discharge speed even at low operating stages.

This means that UniLine door air curtains can usually be operated in the partial load range. How come? A self-regulating flap in front of the air outlet varies the cross-section of the outlet. The air route is narrowed at low operating stages, and the air speed remains high.



## Discharge height

### UniLine

2.3 – 3.0 m



### Tandem

2.7 – 4 m



### ProtecTor

3.5 – 4.5 m

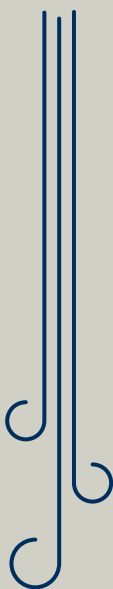

## The payback argument

Our air curtains justify the investment in them after just a short time. Certainly the **UniLine stands out here with its outstanding value for money.** It is the right choice for simple applications and therefore provides you with a convincing argument to persuade your customers.

## Fast delivery

Short delivery times give you flexibility and speed. After all, your customers rely on you. **We deliver all standard units in the shortest possible time.** Put your trust in Kampmann.

# It's your choice

## Tandem

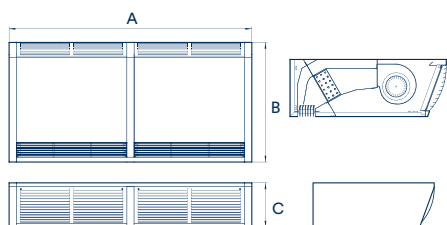

Version	Size	Maximum door width	Depth B	Height C	Length A	Heat output <sup>1)</sup>
		[m]	[mm]	[mm]	[mm]	[kW]
Tandem 300	12	1.25	820	300	1250	4.6 – 9.6
	20	2.00	820	300	2000	8.3 – 18.5
	25	2.50	820	300	2500	10.8 – 26.5
	30	3.00	820	300	3000	13.5 – 30.1
Tandem 365	12	1.25	985	365	1250	7.1 – 14.3
	20	2.00	985	365	2000	12.8 – 27.8
	27	2.75	985	365	2750	18.1 – 41.3

<sup>1)</sup> at LPHW 75/65 °C, t<sub>li</sub> = 20 °C

## Tandem in-ceiling unit

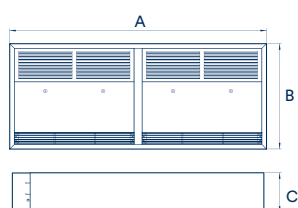

Size	Maximum door width	Depth B	Height C	Length A	Heat output <sup>1)</sup>
	[m]	[mm]	[mm]	[mm]	[kW]
12	1.3	800	300	1200	4.6 – 9.6
20	2.0	800	300	1950	8.3 – 18.5
25	2.5	800	300	2450	10.8 – 26.5
30	3.0	800	300	2950	13.5 – 30.1

<sup>1)</sup> at LPHW 75/65 °C, t<sub>li</sub> = 20 °C

# Uniline

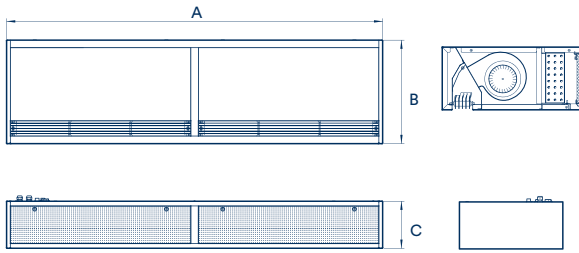

Version	Size	Maximum door width	Depth B	Height C	Length A	Heat output <sup>1)</sup>
		[m]	[mm]	[mm]	[mm]	[kW]
EC fan	10	1.0	550	250	1000	3.4 – 10.3
	15	1.5	550	250	1500	5.3 – 19.5
	20	2.0	550	250	2000	7.6 – 24.1
	25	2.5	550	250	2500	9.6 – 33.7
	30	3.0	550	250	3000	11.1 – 42.8
AC fan	10	1.0	550	250	1000	6.7 – 10.2
	15	1.5	550	250	1500	9.6 – 17.4
	20	2.0	550	250	2000	13.1 – 24.2
	25	2.5	550	250	2500	18.0 – 33.9
	30	3.0	550	250	3000	24.1 – 44.2

<sup>1)</sup> at LPHW 75/65 °C,  $t_{li} = 20$  °C

# Cassette UniLine

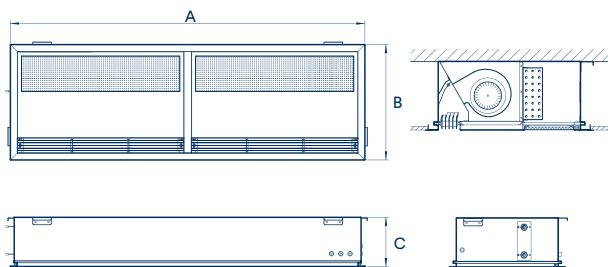

Version	Size	Maximum door width	Depth B	Height C	Length A	Heat output <sup>1)</sup>
		[m]	[mm]	[mm]	[mm]	[kW]
EC fan	10	1.0	600/625	265	1000	3.4 – 10.3
	15	1.5	600/625	265	1500	5.3 – 19.5
	20	2.0	600/625	265	2000	7.6 – 24.1
	25	2.5	600/625	265	2500	9.6 – 33.7
AC fan	10	1.0	600/625	265	1000	6.7 – 10.2
	15	1.5	600/625	265	1500	9.6 – 17.4
	20	2.0	600/625	265	2000	13.1 – 24.2
	25	2.5	600/625	265	2500	18.0 – 33.9

<sup>1)</sup> at LPHW 75/65 °C,  $t_{li} = 20$  °C

# ProtectoR

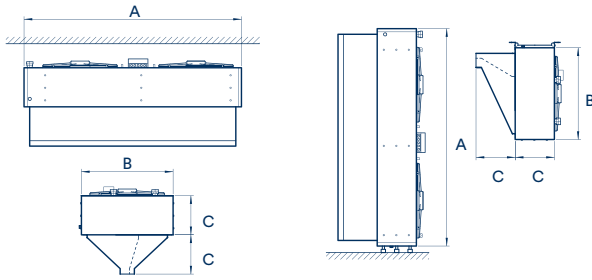

Heat output | Heat exchanger model

Version	Max. discharge height/ throw	Max. door width/ height	Length A	Depth B	Height C	Copper/ aluminium <sup>1)</sup>	Steel, galvanised <sup>1)</sup>	Steel, galvanised, cross-counterflow <sup>2)</sup>
	[m]	[mm]	[mm]	[mm]	[mm]	[kW]	[kW]	[kW]
EC fan	3.5	2250	2000	740	360	15.0 – 49.7	15.0 – 49.7	10.0 – 27.9
	4.5	2250	2000	840	360	22.4 – 71.3	22.4 – 71.3	17.1 – 49.1
	3.5	3250	3000	740	360	22.4 – 74.5	22.4 – 74.5	15.0 – 42.0
	4.5	3250	3000	840	360	33.7 – 107.3	33.7 – 107.3	25.4 – 73.1
	3.5	4250	4000	740	360	30.0 – 99.4	30.0 – 99.4	19.9 – 56.0
	4.5	4250	4000	840	360	45.1 – 143.5	45.1 – 143.5	34.0 – 97.9
	3.5	5250	5000	740	360	37.3 – 123.9	37.3 – 123.9	24.8 – 69.4
	4.5	5250	5000	840	360	56.2 – 179.0	56.2 – 179.0	42.3 – 121.9
	3.5	2250	2000	740	360	33.3 – 43.3	33.3 – 43.3	24.1 – 27.0
	4.5	2250	2000	840	360	53.0 – 66.7	53.0 – 66.7	42.2 – 48.6
AC fan	3.5	3250	3000	740	360	50.0 – 65.0	50.0 – 65.0	36.7 – 41.1
	4.5	3250	3000	840	360	79.5 – 100.3	79.5 – 100.3	65.8 – 72.4
	3.5	4250	4000	740	360	66.6 – 86.7	66.6 – 86.7	48.8 – 54.7
	4.5	4250	4000	840	360	106.0 – 133.8	106.0 – 133.8	87.4 – 96.8
	3.5	5250	5000	740	360	83.3 – 108.3	83.3 – 108.3	61.0 – 68.0
	4.5	5250	5000	840	360	132.5 – 167.2	132.5 – 167.2	109.8 – 120.6

<sup>1)</sup> at LPHW 75/65 °C,  $t_{L1} = 20$  °C

<sup>2)</sup> at LPHW 80/40 °C,  $t_{L1} = 20$  °C

Your digital product finder at  
[www.kampmanngroup.com](http://www.kampmanngroup.com)

Calculate your product online:  
[kampmanngroup.com](http://kampmanngroup.com) > Products > Air curtains

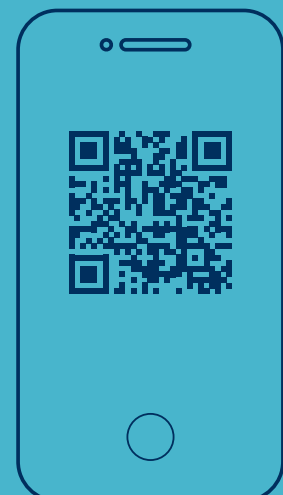





# Convectors

Our low-temperature convectors are durable and responsive. Find the right version for private or commercial use, wall-mounted or as a free-standing heater.

Opt for Kampmann steel convectors to fit within cladding by others or within our PowerKon range of casings. Ultra-responsive: the PowerKon nano with fan assistance.

- + Maximum flexibility thanks to a wide range of products with or without casing.
- + All convectors are suitable for low temperature operation.
- + PowerKon nano with EC tangential fan for ultra-fast responsiveness with low noise emissions

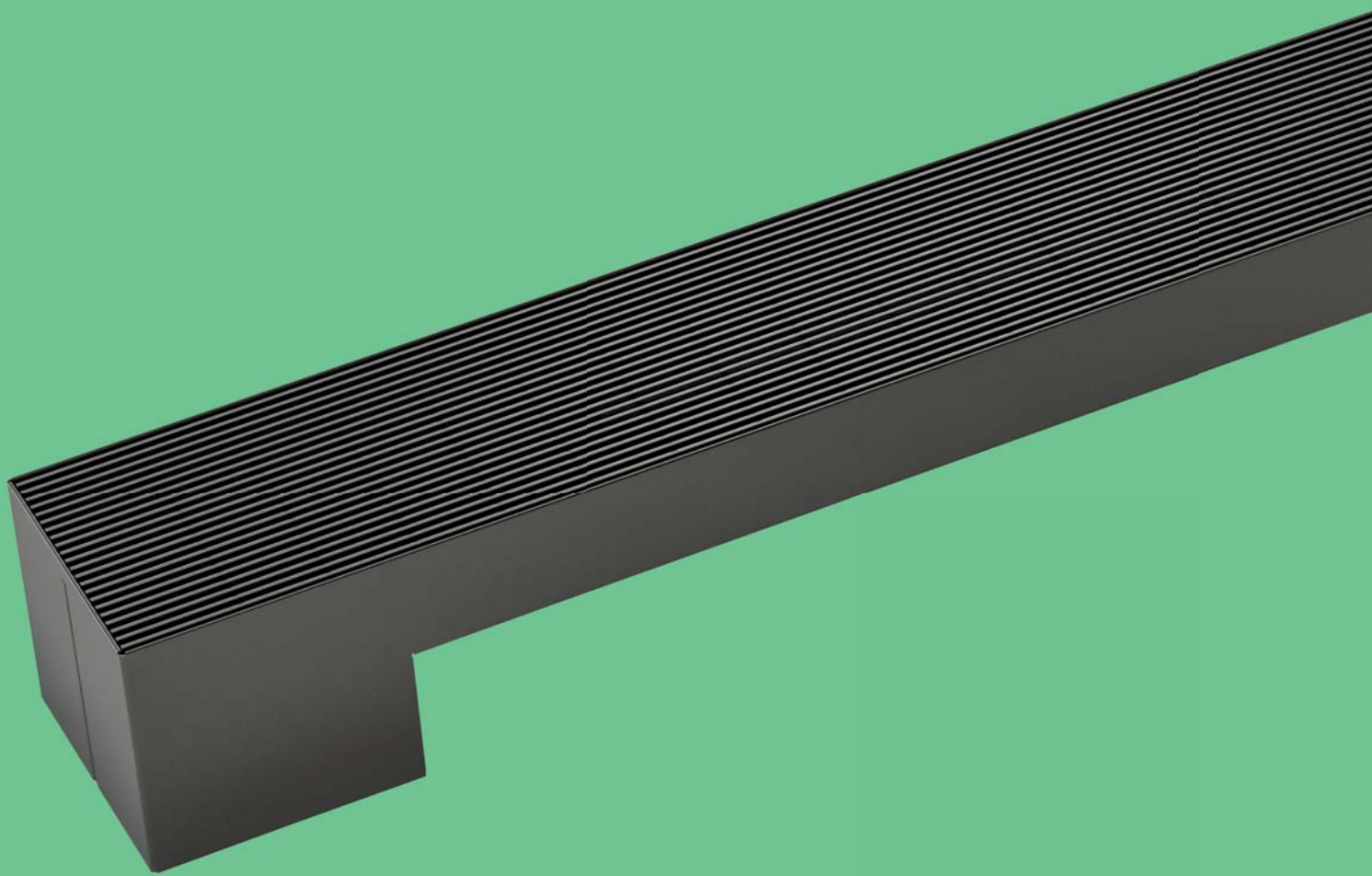

# Surprisingly versatile

You'll never compromise on quality when heating with convectors, whether in the form of architecturally made-to-measure convectors, discreet radiators or as free-standing design elements.

All Kampmann convectors are designed with high-quality heat carriers.

## At the window

### PowerKon + F

Admittedly, trench convectors are the go-to units under floor-to-ceiling windows or glazed façades. But this is not always possible, or perhaps you have a different design in mind.

Then PowerKon +F convectors are the solution for your project. Ultra-discreet and equally effective, thanks to their **high-quality copper-aluminium heat carriers**. And durable with **phosphated, powder coated sheet steel covers**.

But our be-all and end-all is finding the perfect solution for you.





## Easy to install and maintenance-friendly

Let's ask people



We always have our ear to the market. We know from talking to tradespeople and designers that **sturdy metal casings** are of great importance to them and that a **simple maintenance concept** will keep installers and users happy for many years to come. Who would we be if we didn't take that to heart? You can rely on our convectors.

## It's your choice

PowerKon nano

We have incorporated our entire **knowledge and expertise of trench technology into the PowerKon nano**. The **EC tangential fan** provides optimum flow through the copper-aluminium heat exchanger. And yet its operating noise is scarcely audible, our trademark with our trench technology and fan coils. And this free-standing convector cannot fail to attract admiring glances.

Its high-quality casing can be designed in any RAL colour and the design roll-up grille is extremely fine.



## Steel is simply good

Steel convectors are sturdy, customisable and sensibly integrated timelessly into your project.

Kampmann will manufacture units in a variety of lengths, widths and heights – either straight or even curved. **Designed as low-temperature units, steel convectors are perfect for providing full-room air conditioning or as a module for “transitional heating”.**

And yet, at the same time, the unit is virtually invisible. The convectors are discreetly integrated into structural wall casings or are hidden in underfloor trenches covered by design roll-up grilles.

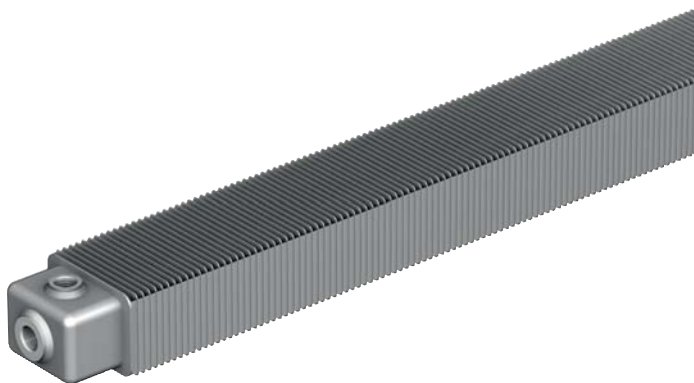

Steel convectors are also durable, reliable and silent. In the best sense, they leave you in peace year after year. This is because the **galvanised steel fins are carefully protected against corrosion.**

## Control options

Simple systems, simple control



Room thermostat

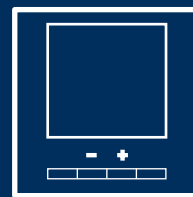

Clock thermostat

We offer various control units in conjunction with thermoelectric actuators. For instance the flush-mounted room thermostat provides a **setpoint setting with main switch and separate switching input for night setback**. The **clock thermostat with display** provides even greater convenience. **Configure three individual operating modes with up to six switching stages for each day.**

# Unobtrusive

## PowerKon + W

If our products had a character of their own, then the PowerKon +W would be the selfless type. It fades into the background and really never wants to be noticed. At least not visually. However, its inner life is as multifaceted as its design is restrained. Our copper-aluminium heat carrier also **performs its service in absolute silence in this wall-mounted convector** .

But even if you take a closer look at its exterior, say during installation or maintenance, you learn to appreciate the details.

**The one-piece casing, for example, can be fitted and dismantled without the need for a tool.** Or its air discharge grille – either perforated or in the form of a linear grille. Take the time to get to know it.

# The solution

## PowerKon QE

The PowerKon QE with electric heating coil offers the ideal solution when the use of a low pressure hot water convector is impossible. The high-output **electric heating coil** delivers high heat outputs in conjunction with fan assistance provided by the EC tangential fan.

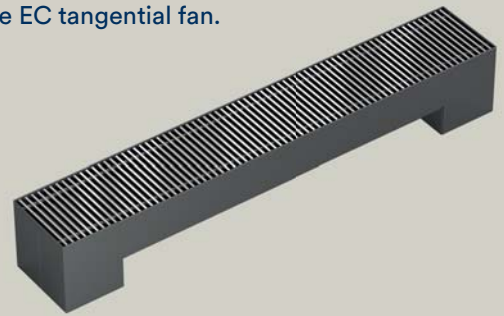

Whether for new build or refurbishments: **One width. One height. Three lengths** – the PowerKon QE impresses with its compact strength. There is no need for more. Every convector is designed for heating and noise efficiency.



# Casings

## Wall-mounted models for Kampmann convectors and fan coils

Our customised casings are robust and multifunctional. **It all comes down to precise site measurement, which we would be happy to provide.**

It's how we provide the basis for your individual wall casings for natural convection-based and fan-assisted systems.

And if you also wish to incorporate comfortable radiant heat, the **front panels can also be designed to carry water.** Designed to perfection, taking into account structural elements like columns, and concealing structural tolerances discreetly in the shadow joints between individual casing units.

# Our convectors at a glance

## Wall-mounted convectors



### PowerKon + W

- > convector optimised for use with low water temperatures
- > fast response due to low water content
- > low surface temperature

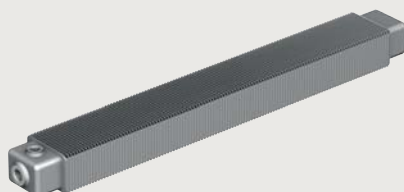

### Steel convector

- > heating with LPHW
- > natural convection
- > in casings or trenches (in-floor installation)

## Free-standing convector



### PowerKon + F

- > convector optimised for use with low water temperatures
- > fast response due to low water content
- > low surface temperature



### PowerKon nano

- > free-standing and versatile
- > usual quietness and high performance
- > EC fan - efficient in terms of noise and energy



### PowerKon QE

- > ideal solution without hot water connection
- > free-standing and versatile in a slimline design
- > high-quality look thanks to powder-coated steel housing



# Fits every time

## PowerKon + F

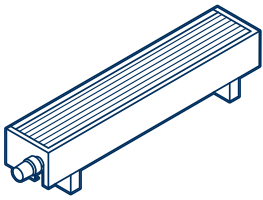

Height	80   130
Depth	130   180   230
Length <sup>1)</sup>	600 – 2600

## PowerKon nano

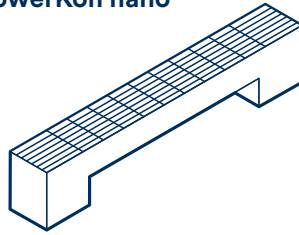

Height	160
Depth	160
Length	950   1150   1400   1800   2150

## PowerKon QE

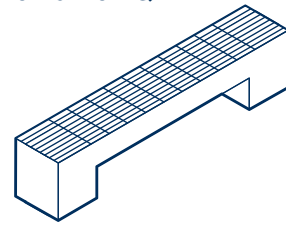

Height	200
Depth	205
Length	825   1250   1700

## PowerKon + W

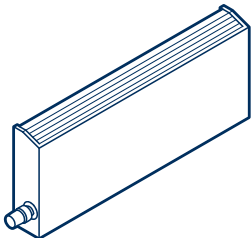

Height	250   400   550   700
Depth	70   120   170   220
Length <sup>1)</sup>	600 – 2600

## Steel convector

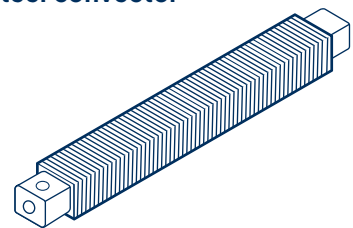

Height	70   150
Depth	50   100   150   200   250   300
Length <sup>2)</sup>	500 – 5000

Dimensions in mm <sup>1)</sup> 200 mm increments <sup>2)</sup> 100 mm increments

# Performance data

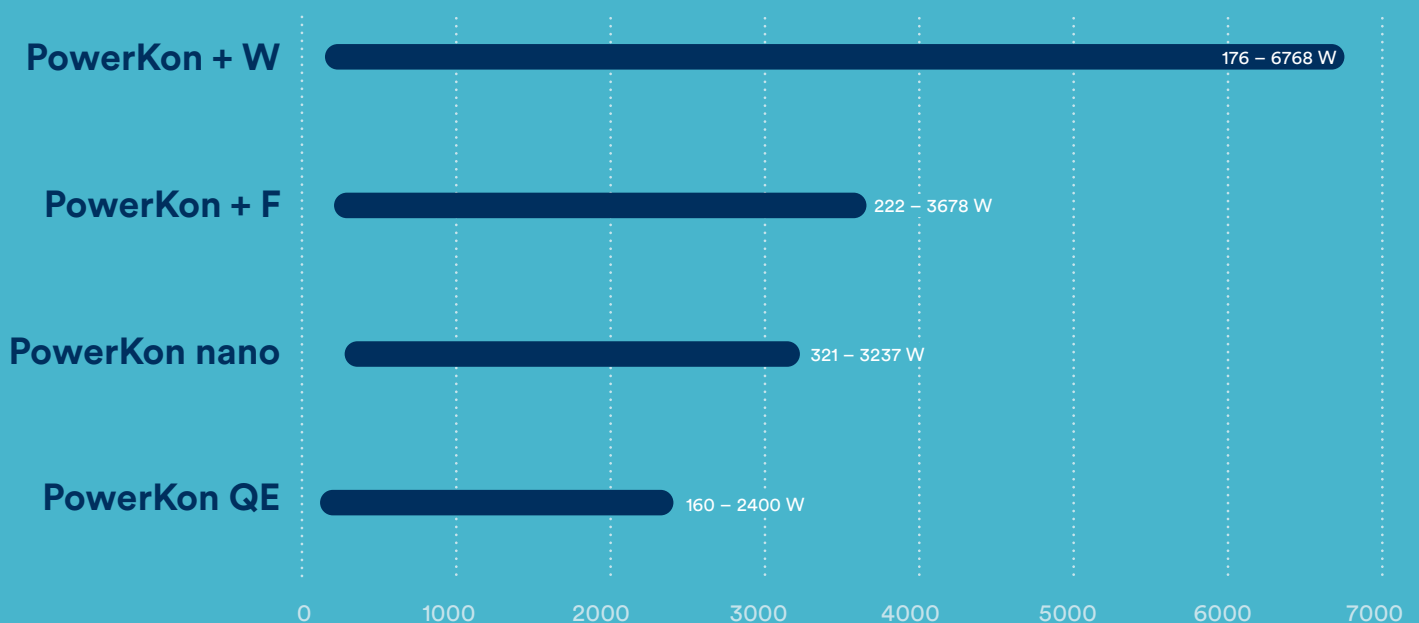

● Heat output at LPHW 75/65/°C,  $t_{L1} = 20$  °C

# It's your choice

## PowerKon + F

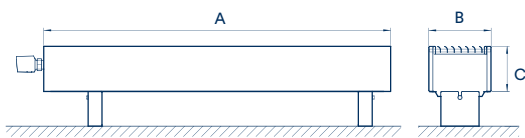

Height C	Depth B	Length A	Heat output <sup>1)</sup>
[mm]	[mm]	[mm]	[W]
80	130	600 – 2600	222 – 1292
80	180	600 – 2600	310 – 1802
80	230	600 – 2600	466 – 2712
130	130	600 – 2600	313 – 1821
130	180	600 – 2600	461 – 2685
130	230	600 – 2600	632 – 3676

<sup>1)</sup> at LPHW 75/65 °C,  $t_{L1} = 20$  °C

## PowerKon nano

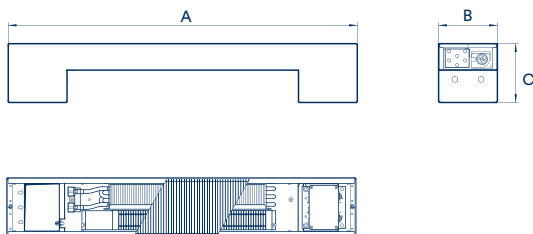

Width B	Height C	Length A	Heat output <sup>1)</sup>
[mm]	[mm]	[mm]	[W]
160	160	950	321 – 851
160	160	1150	497 – 1317
160	160	1400	646 – 1713
160	160	1800	971 – 2574
160	160	2150	1221 – 3237

<sup>1)</sup> at LPHW 75/65 °C,  $t_{L1} = 20$  °C, with fan-assisted convection

## PowerKon QE

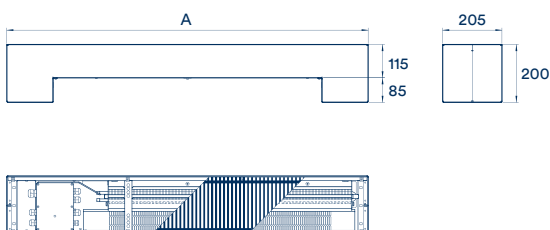

Length A	Height	Width	Heat output <sup>1)</sup>
[mm]	[mm]	[mm]	[W]
825	200	205	160 – 800
1250	200	205	320 – 1600
1700	200	205	480 – 2400

<sup>1)</sup> at LPHW 75/65 °C,  $t_{L1} = 20$  °C

# PowerKon + W

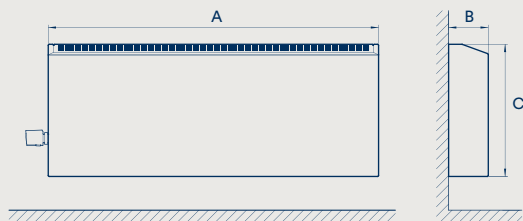

Height C	Depth B	Length A	Heat output <sup>1)</sup>
[mm]	[mm]	[mm]	[W]
250	70	600 – 2600	176 – 1044
250	120	600 – 2600	354 – 2100
250	170	600 – 2600	529 – 3143
250	220	600 – 2400	711 – 4221
400	70	600 – 2600	197 – 1169
400	120	600 – 2600	417 – 2477
400	170	600 – 2600	637 – 3785
400	220	600 – 2400	891 – 5289
550	70	600 – 2600	216 – 1284
550	120	600 – 2600	482 – 2860
550	170	600 – 2600	752 – 4468
550	220	600 – 2400	1021 – 6065
700	70	600 – 2600	224 – 1330
700	120	600 – 2600	515 – 3057
700	170	600 – 2600	801 – 4755
700	220	600 – 2600	1140 – 6768

<sup>1)</sup> at LPHW 75/65 °C, t<sub>l</sub> = 20 °C

Your digital product finder at  
[www.kampmanngroup.com](http://www.kampmanngroup.com)

Calculate your product online:  
[kampmanngroup.com](http://kampmanngroup.com) > Products > Convector

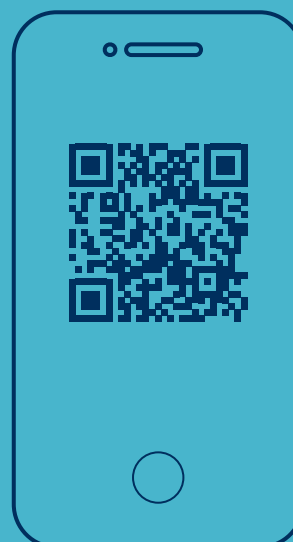

# Local ventilation units

It is with good reason that local ventilation units are popular in building refurbishments. Local units allow the room to breathe again at the latest when retrofitted façade insulation cuts off the air. And they do so with relatively minimal intervention to the structure of the building.

Local solutions are becoming more popular in new buildings as well. No wonder, because when it comes to individual room air conditioning, they have many advantages over their big brother, the centralised unit.

- + healthy indoor climate with precise air change
- + range of units from pure ventilation to full air conditioning units
- + local ventilation including heat recovery



# Our local ventilation units at a glance

	Supply air	Extract air	Heating	Cooling	Heat Pump ready	Heat recovery	Moisture recovery	Secondary air	2- and 4-pipe	Supply air volume flow
<b>Cabinet unit</b> <b>WZA</b> 	✓	✓	✗	✗	✗	✓	✓	✗	✗	1000 m³/h
<b>Sill units</b> <b>BZAS</b> 	✓	✓	✓	✓	✓	✓	✓	✓	✓	110 m³/h
<b>FZAS</b> 	✓	✓	✓	✓	✓	✓	✓	✓	✓	120 m³/h
<b>Trench technology</b> <b>UZAS</b> 	✓	✓	✓	✓	✓	✓	✗	✓	✓	120 m³/h
<b>UZA</b> 	✓	✓	✓	✓	✓	✗	✗	✗	✓	120 m³/h
<b>UZS</b> 	✓	✓	✓	✓	✓	✗	✗	✓	✓	120 m³/h

# Installed

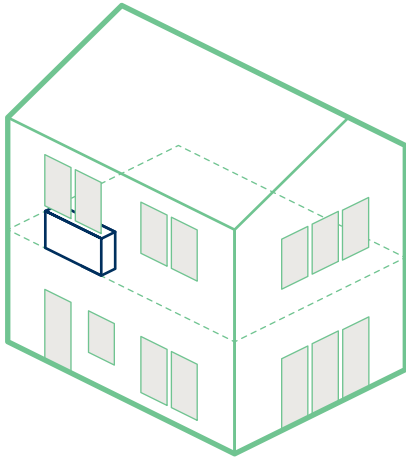

## Sill units

- > Sill units are installed under windows. There is minimal ingress into the shell of the building. The perfect choice for refurbishments.
- > Used in conjunction with our diffusers, architects love the freedom of being able to encase sill units within customised furniture.

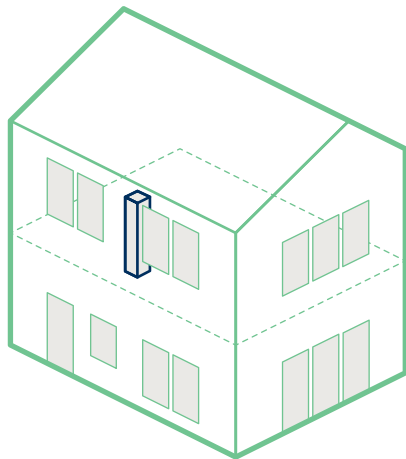

## Façade units

- > When you opt for local full air conditioning in new buildings, you opt for façade ventilation.
- > From the outside, the cladding options are so varied that façade units are often regarded as design elements rather than technical building services units.

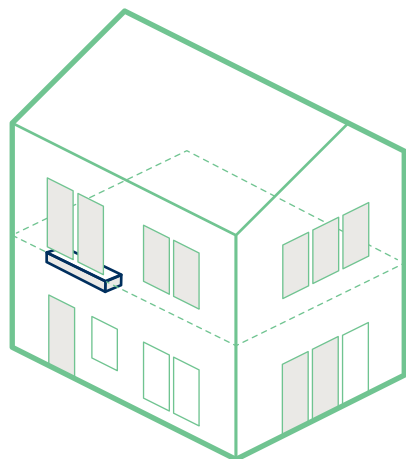

## Trench technology

- > It doesn't get more space-saving and unobtrusive than this. There's something for everyone from simple solutions to high-end units with heat recovery and mixed air operation.
- > And they come with a wide range of design grille covers.

All units are optionally available with factory-fitted controls, room control units and interfaces for all popular building automation systems

Your digital product finder at  
[www.kampmanngroup.com](http://www.kampmanngroup.com)

Find your product online:  
[kampmanngroup.com](http://kampmanngroup.com) > Products > Local ventilation units

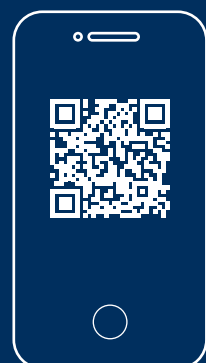



# Finally ventilation in schools

Healthy, automatic and quiet

Mechanical ventilation in schools is finally getting the attention it deserves to contain disease waves. However, let's not forget that a low concentration of CO<sub>2</sub> is needed throughout the year for concentrated work.

Adequate supply air and very low noise emissions are mandatory with modern ventilation technology. Our **WZA** operates in nominal air mode with a sound pressure level of only **35 dB(A)** and delivers 800 m<sup>3</sup>/h – naturally with 100% outside air and heat recovery.

**One-button operation** enables users to intuitively switch through Automatic and Shock ventilation modes, as well as Stage 1 and Stage 2.



# Mixed air versus displacement air

There's a definite answer in classrooms

Displacement ventilation is fantastic in offices: a temperature-controlled air volume for around four people is fed in at a low pulse rate and at a slight undertemperature close to floor level. This air rises by the thermal effects of machines and people, displacing the room air.

This is not possible in classrooms! The larger volume of cool supply air for 25 to 30 students would be extremely uncomfortable. The teacher would quickly switch off the unit. What is more, the low-pulse supply of air would be incapable of ventilating the classroom evenly and fully throughout the year.

**Mixed ventilation is therefore the right choice** in schools. It feeds in large volumes of air along the ceiling of the room, which then sink down into the entire room at low air speed and flush through it. With no draughts!

# Moisture recovery

Local school ventilation unit WZA



This component has it all: the enthalpic exchanger in the WZA recovers a large part of the heat or cold from the extract air. **But to a greater extent, by recovering moisture, it also protects the students' natural viral defences.** We now know that adequate humidity in a room protects people's nasal mucous membranes, strengthening their own viral barrier. The residual risk of infection is thus halved.

**Incidentally, the enthalpic exchanger does not produce condensate and so is easier to install and operate.**



# High-end ventilation from the floor

## UZAS

The UZAS local ventilation unit is packed with high-quality components for **supply air, extract air, secondary air, mixed air, heat recovery, heating and cooling**. The underfloor unit is placed directly along the façade, usually under floor-to-ceiling windows. The air routing is designed for maximum comfort. **Only a 345 mm wide design grille is visible**, which can be easily removed. This means that all components can also be removed for maintenance.

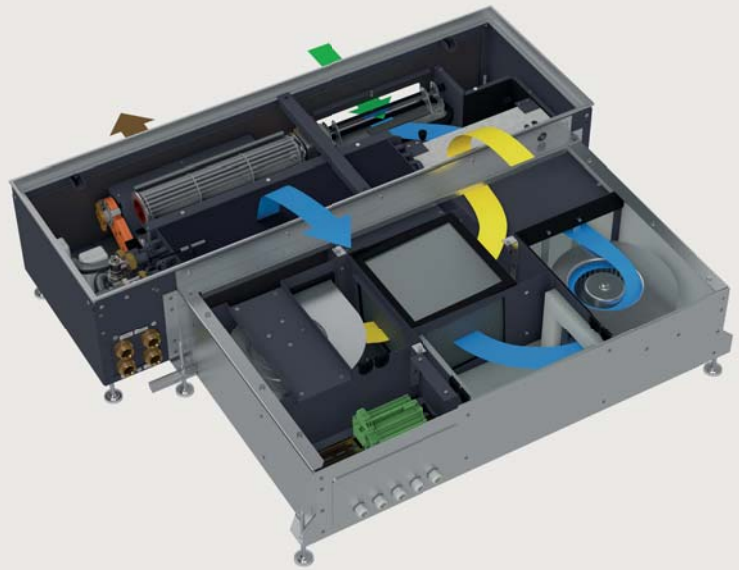

## Local ventilation in offices

The demands for a comfortable working environment are becoming ever greater

How do employees in offices work in a focused and motivated way? Fortunately, operators, investors and, above all, architects of office buildings are asking this question when it comes to design.

Because, after all, well-thought-out structural concepts all contribute to enhancing performance at the workplace. **A pleasant working environment might include, for example, a clear view outside.** The use of glazed façades has therefore been very popular for some time. It allows plenty of daylight to flood into the offices, but at the same time increases the heat load. The IT systems do the rest. A challenging environment for efficient air conditioning, which also needs to take into account increased demands on the part of employees. Temperature, air movement, acoustic stress as well as other air quality factors, such as humidity and CO<sub>2</sub> content – all this needs to be controlled with air conditioning systems for ventilation, cooling and heating.

Ventilation systems are now standard in new buildings. Legal requirements and energy efficiency standards now mean that opening windows for ventilation is no longer a legitimate alternative. But **external influences, such as street noise or fine dust and pollen in the outside air, make it clear that ventilation through open windows does not go hand in hand with a pleasant working environment.** Local units are increasingly becoming the systems of choice for this kind of application. They have decisive benefits over central ventilation units. **Individual room temperature control and ventilation** is often more energy-efficient and, to a large extent, more comfortable for employees. Façade units or underfloor versions are particularly popular in new buildings.

**Local ventilation units are unrivalled when ventilation needs to be retrofitted to existing buildings.** In these cases, sill units or façade units are often the best choice, as there is minimal ingress into the structure of the building.



# Air humidity

Increasingly in focus

People's well-being is a pretty good indicator of whether something is wrong with the room air. However, far too rarely is it recognised that it is the air humidity that is actually too low. **The malaise usually stems from mucous membranes that are too dry. As a result, viruses and bacteria have a much easier time breaking through the immune system, and infections can develop more quickly.** Maintaining a 50% humidity level can prevent mucous membranes from drying out. People with allergies and asthma also quickly appreciate good air humidity. **The local ventilation units BZAS and FZAS with their enthalpic heat exchangers provide for 65% humidity recovery levels.** They deliver all the aspects crucial for comfortable air conditioning.

## Piggy back



The BZAS basic unit controls the **supply air and extract air** through the openings in the building shell. Its **enthalpic heat exchanger** recovers both heat and moisture. BZAS is designed to be used **with Venkon fan coils**. A total of three EC fans then provide for operation with supply air, secondary air and mixed air.

# Heat pumps and chillers

Water-based systems for heating and cooling buildings are future-proof. Minimal refrigerant is used when chillers and heat pumps are combined with room units. And only in the unit, not in the building.

- + Cold water-based systems are becoming even more efficient and convenient with the option of low-noise operation, e.g. during the night hours.
- + Many models feature the low GWP refrigerant R32 for a 75% reduction in the greenhouse effect.
- + The EC fans can be controlled continuously variably and thus provide precisely the required output. No more and no less.
- + Many of our KaClima R32 units have an integrated circulation pump, safety valve and dirt trap (available in some cases as an option on other models).



# Our chillers and heat pumps at a glance



## KaClima S

- > R32 refrigerant to reduce the CO<sub>2</sub> equivalent by up to 75%
- > leaving water temperature control
- > energy efficiency class A+++ in accordance with (EU) Delegated Regulation No. 811/2013



## KaClima M

- > R32 refrigerant to reduce the CO<sub>2</sub> equivalent by up to 75%
- > constant flow temperature control for consistent output by consumers
- > energy efficiency class A+++ in accordance with (EU) Delegated Regulation No. 811/2013



## KaClima L

- > R32 refrigerant to reduce the CO<sub>2</sub> equivalent by up to 75%
- > leaving water temperature control
- > energy efficiency class A+++ in accordance with (EU) Delegated Regulation No. 811/2013



## KaClima XL

- > two separate cooling circuits for maximum operating reliability
- > integrated safety valve and differential pressure switch
- > low refrigerant volume to avoid harmful F-gases



## KaClima XXL

- > two separate cooling circuits for maximum operating reliability
- > constant flow temperature control for consistent output by consumers
- > low starting currents



## KaClima R290 (propane)

- > refrigerant R290 to reduce the CO<sub>2</sub> equivalent
- > leaving water temperature control
- > energy efficiency class A++ in accordance with (EU) Delegated Regulation No. 811/2013

# R32

The “low GWP” refrigerant



Reducing the volumes of refrigerant traded (phase down) made it necessary to look for alternatives. The product of choice is known as **R32** and boasts **low GWP (Global Warming Potential)**. The **cooling circuit is also more efficient**, so that our KaClima models achieve A+++ or A++ energy efficiency classes. The quantities required are also 30% lower than the R410A refrigerant used up to now.

## The thing about hydraulics

....it's easier than you think.  
With our hydraulic box



Save design and assembly time with **all the essential components, such as system isolators, pump and safety valve, vapour-tightly insulated in a shock-proof housing**. Available in three combinable sizes with 12, 20 and 35 kW.

## Use of the hydraulic box

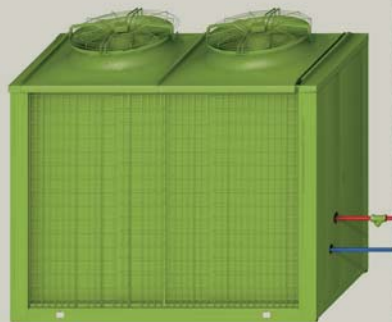

Chiller/heat pump (outdoor installation shown here)

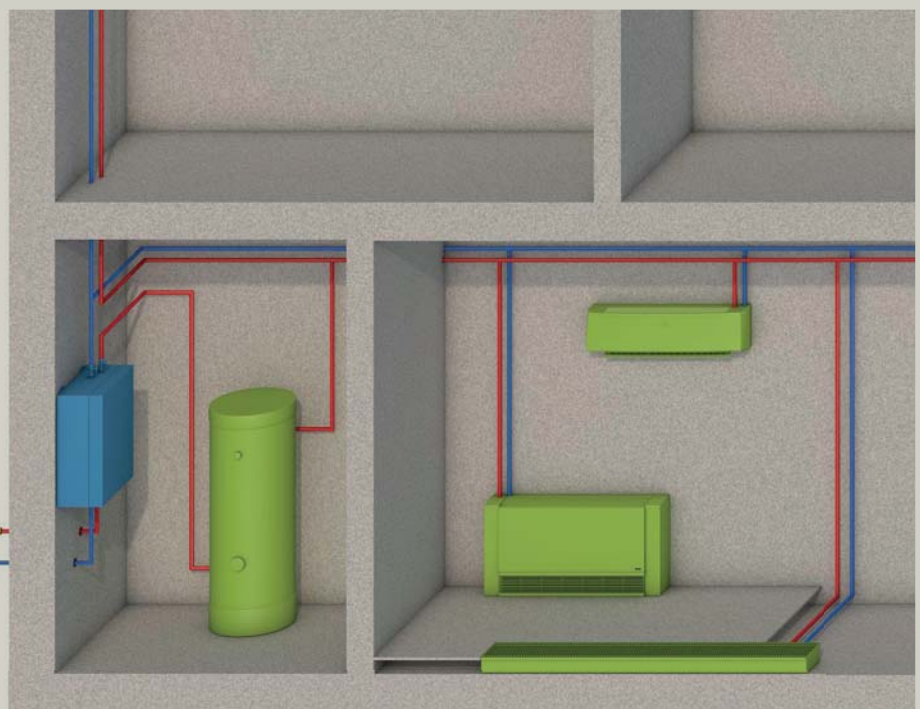

Plant room with hydraulic box and hot water boiler

Connected room units, such as Venkon fan coils, Katherm HK or KaCool (shown here in the occupied zones, but also suitable for use with industrial unit heaters)

# Heating and air conditioning units for heat pumps

Regardless of why you are interested in heat pump solutions, whether to reduce your operating costs or for reasons of sustainability, they contribute to our target of decarbonising our energy supply.



Let us present one of the widest product ranges of units suitable for use with heat pumps – “Heat Pump ready” as it were. Choose our products that carry this label for your future-proofed heating and cooling system.





# The heat pump system

The basic idea is not new: a heat generator supplies warm water to room units, which then use the warm water to control the temperature in the rooms. In the past, we had oil or gas-fired boilers (heat generators), today we have heat pumps.

Today's room units are fan-assisted convectors, where we previously used radiators. Fan-assisted units rapidly achieve 3-4 times the output of conventional radiators particularly when operated with low system temperatures.

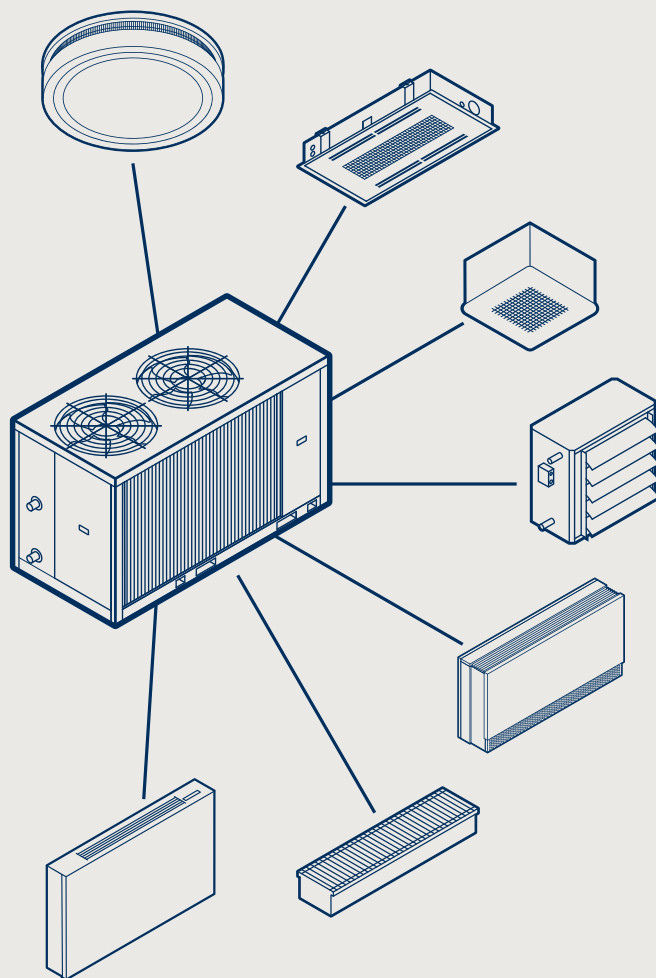

## Cooling with heat pumps

**Almost as an after-thought, you also benefit from a heat pump's cooling function.** Many heat pumps already incorporate this functionality. You can therefore supply the appropriate room units with hot water, but also with cold water, which you can use to cool your building. There may be a need for further insulation of the pipes and the removal of condensate water depending on the cooling output you require.

So why not consciously design in a cooling function from the get-go. Then you're sure to have a lot of pleasure with this added comfort.

# It's your choice

## KaClima S

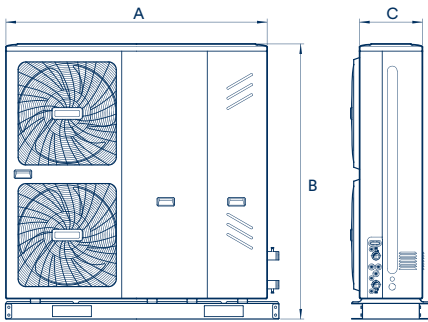

Size	Width A	Height B	Depth C	Cooling output <sup>1)</sup>	Heat output <sup>2)</sup>
	[mm]	[mm]	[mm]	[kW]	[kW]
21	1295	718	429	4.7	4.3
31	1295	718	429	7.0	6.3
41	1385	865	526	7.5	8.1
51	1385	865	526	8.2	10.0
61	1385	865	526	11.5	12.4
71	1385	865	526	12.4	14.1
81	1385	865	526	14.0	16.0
91	1129	1558	528	17.0	18.0
101	1129	1558	528	21.0	22.0
121	1129	1558	528	26.0	26.0
141	1129	1558	528	29.5	30.0

<sup>1)</sup> at CHW 7/12 °C, outside temperature 35 °C

<sup>2)</sup> at LPHW 45/40 °C, outside temperature 7 °C

## KaClima M

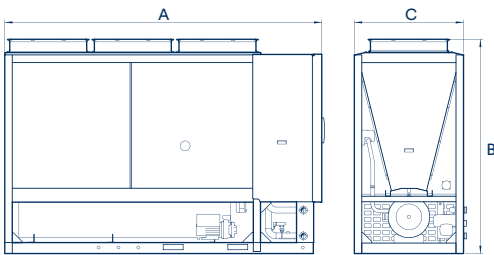

Size	Width A	Height B	Depth C	Cooling output <sup>1)</sup>	Heat output <sup>2)</sup>
	[mm]	[mm]	[mm]	[kW]	[kW]
1182	2337	1130	2152	53.1	53.3
1202	2337	1130	2152	58.8	66.7
1252	3190	1130	2155	72.4	79.1
1302	3190	1130	2155	78.4	85.0
1352	3190	1130	2155	85.3	91.2

<sup>1)</sup> at CHW 7/12 °C, outside temperature 35 °C

<sup>2)</sup> at LPHW 45/40 °C, outside temperature 7 °C

## KaClima L

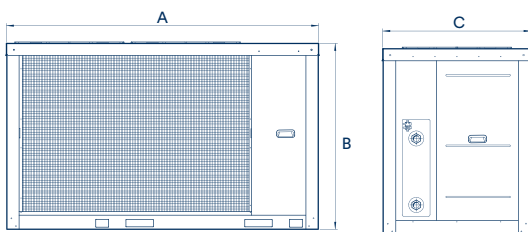

Size	Width A	Height B	Depth C	Cooling output <sup>1)</sup>	Heat output <sup>2)</sup>
	[mm]	[mm]	[mm]	[kW]	[kW]
101	1920	1340	1005	24.1	24.3
121	1920	1340	1005	26.6	28.8
141	1920	1340	1005	30.3	34.2
162	2274	1480	1060	43.8	50.5
182	2274	1480	1060	49.7	54.7
222	2274	1480	1060	56.8	63.4
302	3300	1510	1100	70.1	74.9
352	3300	1510	1100	80.2	85.2
402	3300	1510	1100	94.2	102.0

<sup>1)</sup> at CHW 7/12 °C, outside temperature 35 °C

<sup>2)</sup> at LPHW 45/40 °C, outside temperature 7 °C

## KaClima XL

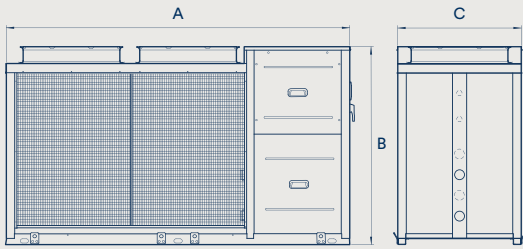

Size	Width A	Height B	Depth C	Cooling output <sup>1)</sup>	Heat output <sup>2)</sup>
	[mm]	[mm]	[mm]	[kW]	[kW]
<b>454</b>	3310	1900	1200	115.0	118.0
<b>504</b>	3310	1900	1200	127.0	130.0
<b>554</b>	3310	1900	1200	139.0	150.0
<b>604</b>	3310	1900	1200	152.0	170.0
<b>654</b>	4300	1900	1200	164.0	190.0
<b>704</b>	4300	1900	1200	176.0	210.0
<b>754</b>	4300	1900	1200	196.0	230.0
<b>804</b>	4300	1900	1200	215.0	250.0
<b>854</b>	4300	1900	1200	233.0	268.0

<sup>1)</sup> at CHW 7/12 °C, outside temperature 35 °C

<sup>2)</sup> at LPHW 45/40 °C, outside temperature 7 °C

## KaClima XXL

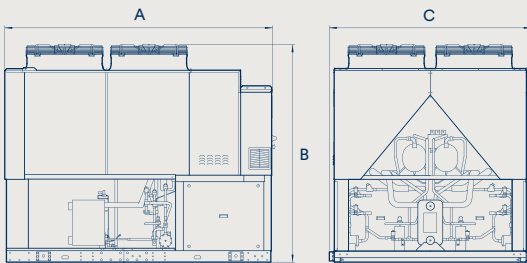

Size	Width A	Height B	Depth C	Cooling output <sup>1)</sup>	Heat output <sup>2)</sup>
	[mm]	[mm]	[mm]	[kW]	[kW]
<b>803</b>	3118	2520	2250	215.0	225.0
<b>904</b>	4114	2520	2250	240.0	255.0
<b>1004</b>	4114	2520	2250	265.0	280.0
<b>1104</b>	4114	2520	2250	290.0	310.0
<b>1204</b>	4114	2520	2250	320.0	335.0
<b>1304</b>	5091	2520	2250	355.0	375.0
<b>1454</b>	5091	2520	2250	390.0	415.0
<b>1604</b>	5091	2520	2250	430.0	455.0
<b>1855</b>	6066	2520	2250	500.0	530.0
<b>2106</b>	6066	2520	2250	556.0	584.0

<sup>1)</sup> at CHW 7/12 °C, outside temperature 35 °C

<sup>2)</sup> at LPHW 45/40 °C, outside temperature 7 °C

Your digital product finder at  
[www.kampmanngroup.com](http://www.kampmanngroup.com)

Calculate your product online:

[kampmanngroup.com](http://kampmanngroup.com) > Products > Heat pumps and chillers

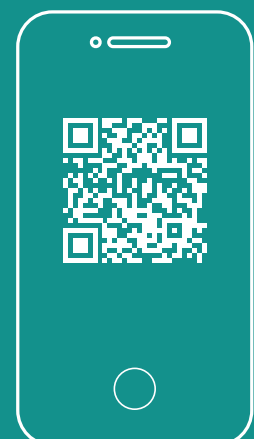

# Chilled ceiling systems

Isn't it paradoxical that our biggest product is, at the same time, one of the most flexible systems ever? There are always a lot of things happening on the ceiling. Lighting, sprinklers, smoke detectors, air vents. It all comes down to planning to ensure that there is enough space for our pipework and profiles.

We can look after that on your behalf.

- + totally silent cooling and heating
- + maximum architectural freedom with metal and gypsum board ceilings
- + doubles as an acoustic ceiling for stress-free offices
- + available as a chilled ceiling or chilled sail
- + combined with ventilation products or local units to cover peak loads
- + design and complete installation by Kampmann, on request



# A question of belief? Gypsum board or metal ceiling

There are several ways of approaching this issue.

**Metal ceilings are the most efficient way.**

**Gypsum board chilled ceilings are the most flexible way.**

And we'll explain why.



# Metal ceiling

Just go the whole hog

In this case, the visible ceiling of the room is made of **metal cassettes**. **No gypsum board ceiling comes close to its radiation power.**

And its interior is also made of metal.  
The cooling and heating pipes are copper.  
The conductivity profiles are made of aluminium.

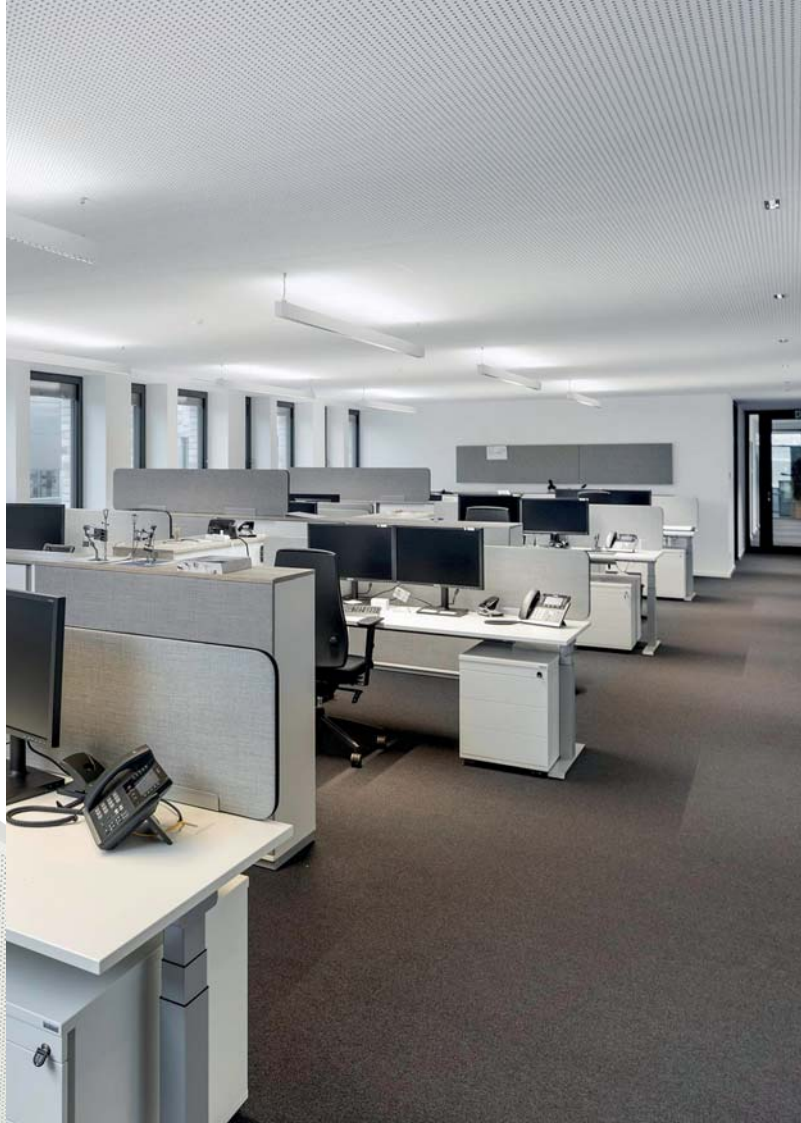
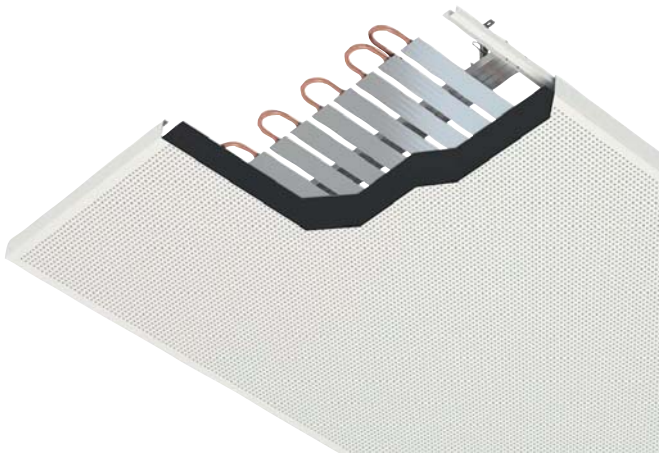

# Doing one thing without leaving the other

Chilled ceiling + Katherm



Sensible combinations of systems make us happy. And you too probably. Combine your chilled ceiling with Katherm trench technology for a comfortable heating system. At the same time, you'll be boosting your system in terms of its responsiveness speed.

# Gypsum board

and much more

Don't write off gypsum board yet. Let's take a closer look. **The cooling and heating pipework is made of plastic.** **The pipes are laid more closely together than in a metal chilled ceiling.** But this version is worth looking at because of its aluminium conductivity profiles that produce the surface contact with the gypsum board. And especially when it comes to price comparisons.

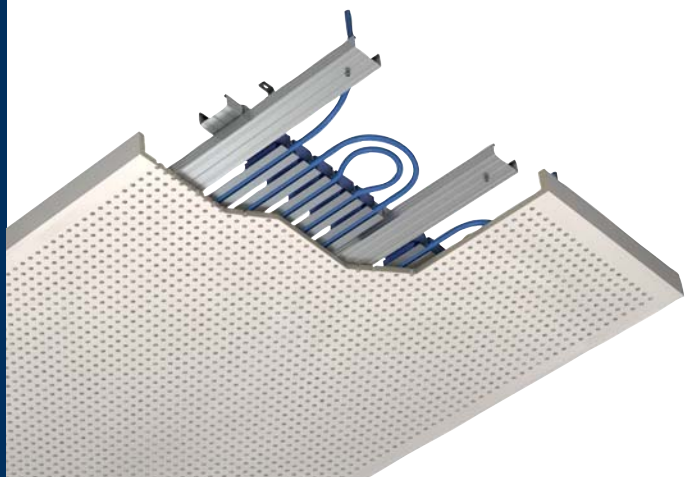

# Our chilled ceiling systems at a glance

**Chilled ceilings**



**Gypsum board ceiling**

- > with cooling or heating pipe made of copper-aluminium thermal conductivity profile
- > Nonius hangers
- > C-ceiling profiles and quick-release cross connectors



**Metal ceiling**

- > with cooling or heating pipe made of copper-aluminium thermal conductivity profile

**Chilled sail**

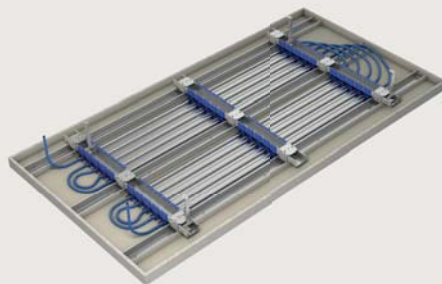

**Gypsum plaster sail**

- > additional lateral edge for visual privacy
- > excellent individuality through in-situ assembly

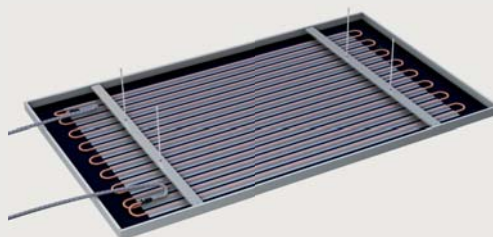

**Metal sail**

- > additional lateral edge for visual privacy
- > high convective output



# Installed

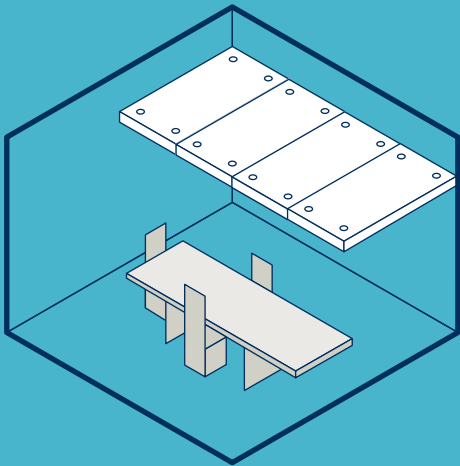

## Chilled ceilings

- > unlike chilled sails, chilled ceilings have a closed surface
- > 60% of the heat transfer is by radiation exchange

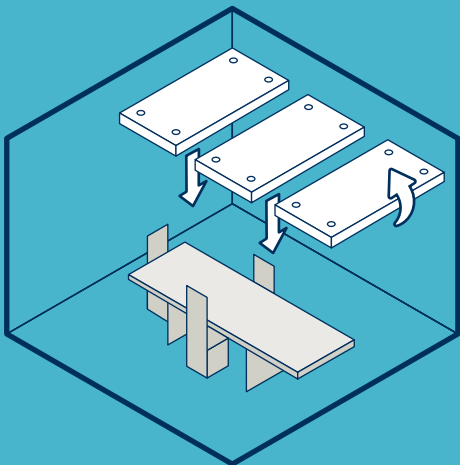

## Chilled sail

- > higher cooling output
- > consists of multiple suspended ceiling elements
- > air circulation around the chilled sail up to the ceiling slab

Your digital product finder at  
[www.kampmanngroup.com](http://www.kampmanngroup.com)

Find your product online:

[kampmanngroup.com](http://kampmanngroup.com) > Products > Chilled ceiling systems

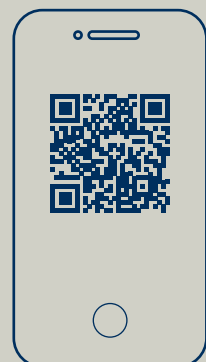

# You still need to finish the ceiling

It might sound offhand but it's true. In terms of the **extensive ceiling work that nonetheless needs to be done during construction, the work involved in 'activating' the ceiling is a drop in the ocean.** Radiant ceilings and chilled sails save operating costs with minimal investment.

# Perforated? Primary air!

**Diffuser for perforated metal chilled ceilings and sails**

When used in conjunction with a perforated metal ceiling, the MDA produces a draught-free Coanda air stream across the ceiling. It is completely invisible to the users of the room. It is simply **placed on the metal ceiling** from above with magnetic straps without the need for any tools. **However, you can also leave the installation to us.**

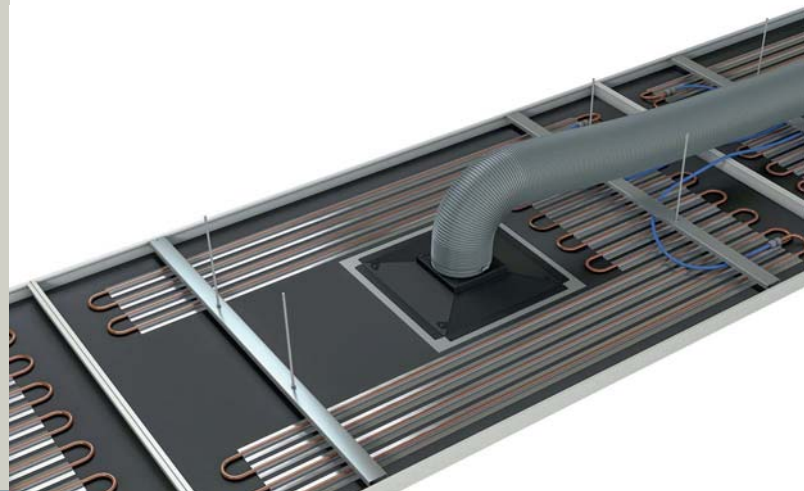

# Acoustic ceiling

It has been proven that in addition to temperature control, room acoustics also have an influence on employee satisfaction and on the performance of office employees.

The following are critical:

- > silence for concentrated work
- > understanding speech in large rooms and
- > good sound insulation

Absorption is the means of damping sound produced in the room itself. **Perforated chilled ceilings are ideal for this. Perforated chilled sails are the perfect answer to this.**



# Unforeseen synergies

Chilled ceiling systems with local units



**For example with the shallowest fan coil on the market.** The KaDeck is VDI 6022-compliant. Available in various designs it can be installed on the wall or in the middle of the room. Of course, always without producing draughts. The entire base of the unit doubles as a revision flap.

# Consultation

Just give me a price. Your local contact would be happy to answer this. They don't really even have to do the sums. **Because we have translated our experience from many chilled ceiling projects into a rough calculation tool.** Just a few details from you and you'll get an answer you can really work with. Incidentally, we never gamble. Not with chilled ceilings nor with our other product ranges. You can bet on that.

[kampmanngroup.com/service](https://kampmanngroup.com/service)



# Control technology

The connectivity of building services components in buildings is now state of the art. Standardised automation networks ensure a cross-trade interplay of systems, killing two birds with the one stone: the demand for improved energy consumption of the entire company and increased comfort.

Our KaControl control system can do just that – and has been doing so for many years.

- + harmonised operation of heating, cooling and ventilation units
- + linking of all functional areas
- + easy to install
- + flexible to use
- + from analogue to cloud-based – you'll always have the right communication
- + central maintenance and fault reporting management

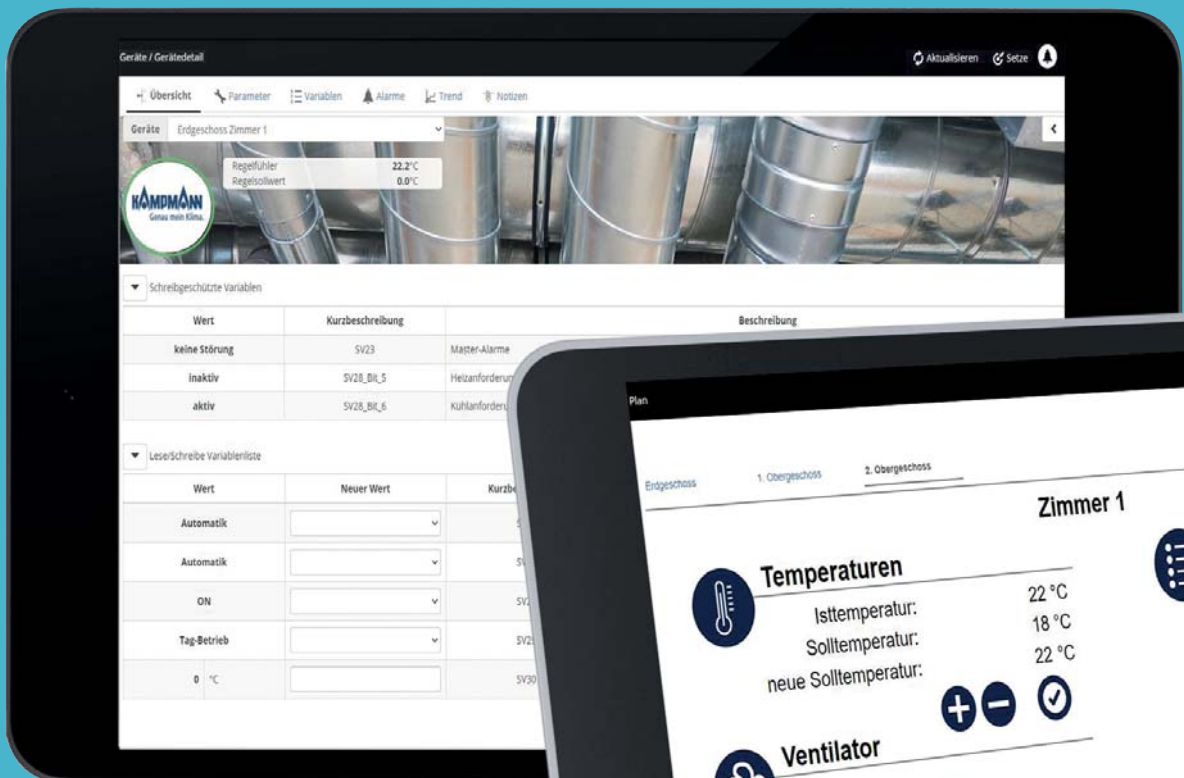

# Decentralised heating and cooling units

Room control unit with automation functions (window contact, hotel guest card activation, temperature detection)?

Stand-alone solution

A stand-alone solution for each room or system with multiple networked rooms?

Networked system

No

Yes

Room control units

Electromechanical room control units



KaControl room automation system

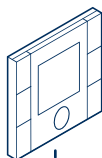

Building automation/BMS systems

System solution

Air handling unit installed?

Yes

No

KNX/Modbus RTU

Modbus TCP/BACnet IP

optional

Device manager

KaControl SEL4.0 secondary air control panel

optional integration

optional

optional

Secondary air unit

# From stand-alone solution to complete system

Our control programme ranges from electromechanical room control units to the KaController with initial automation functions to the SEL4.0 secondary air control panel for the management of decentralised units and simple ventilation requirements. We also have the AUL outside air control panel for ventilation and air conditioning systems (heating/cooling/ventilation) including complex ventilation rules.

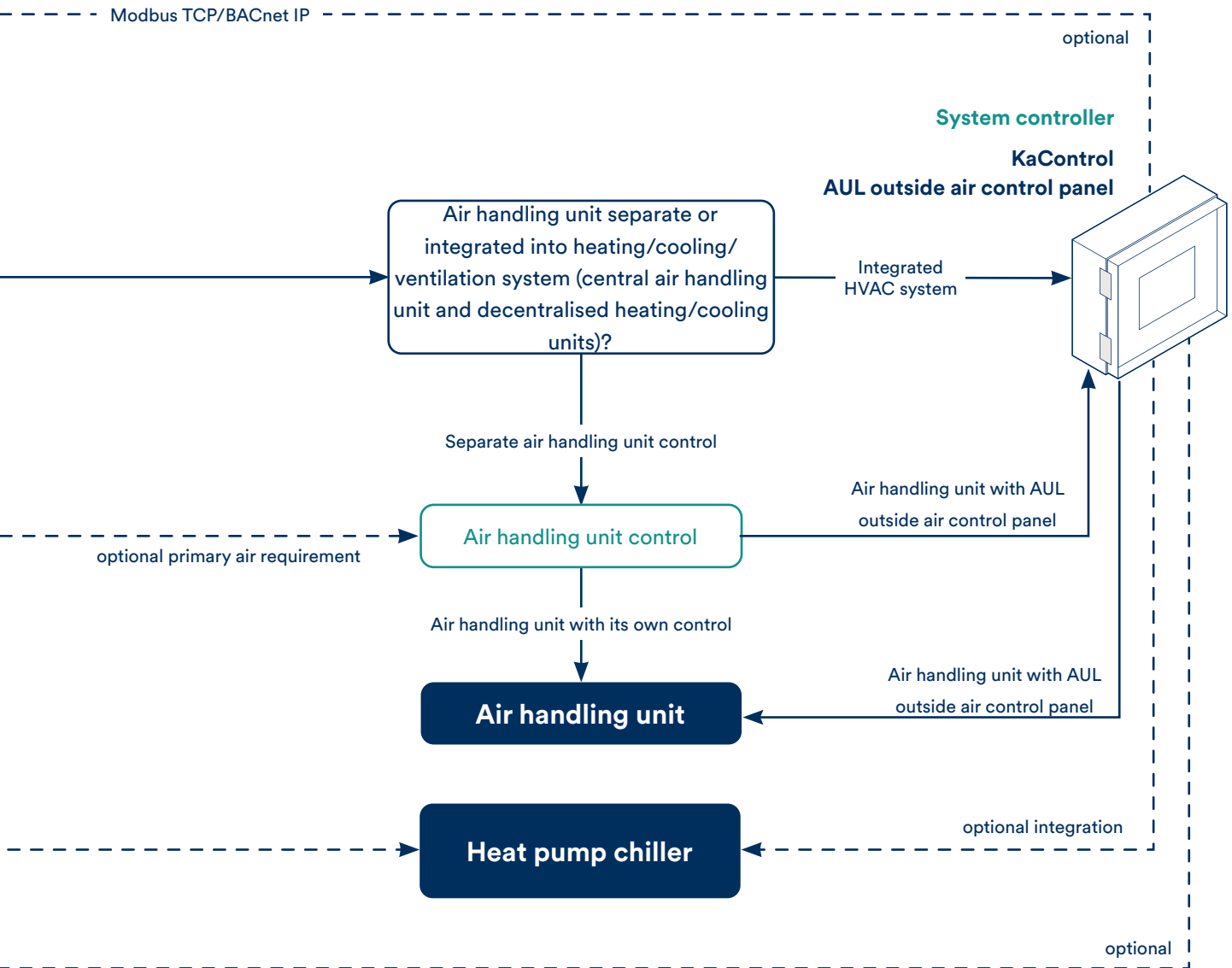

# Outsourcing MSR expertise

Markets and business models are constantly changing. New vendors, especially start-ups, are engaging with the Smart Home, while many manufacturers in the automation industry are focusing more on software and services to support building operations.

**‘Equipment-orientated’ instrumentation, control and automation (ICA) is thus increasingly becoming a core focus of equipment manufacturers.** Of course, we are also working on this and can operate all expansion stages of the control technology in the unit itself.

## Heating, cooling, ventilation – automated, connected



The entire Kampmann range can be networked and centrally controlled.



# Electromechanical control

Of course, the units can be more than just networked and automated. **If the units do not have their own control, all components, such as fans, valves and sensors, are wired to a terminal block.** All the functions of the unit are provided externally here, for example by building automation. We have a selection of room controllers for simple control tasks.

# Stand-alone or part of the BMS



Our KaControl range is the gateway to all intelligent control logic for our products. We provide systems as a stand-alone complete solution for the operation and monitoring of heating, cooling and ventilation functions. However, often air conditioning systems need to be integrated into building automation systems (BA). KaControl also offers the appropriate interfaces, computing units and user interfaces for this. **Thus, KaControl ranges from the smart room control unit to an individual user interface within the building automation network.**

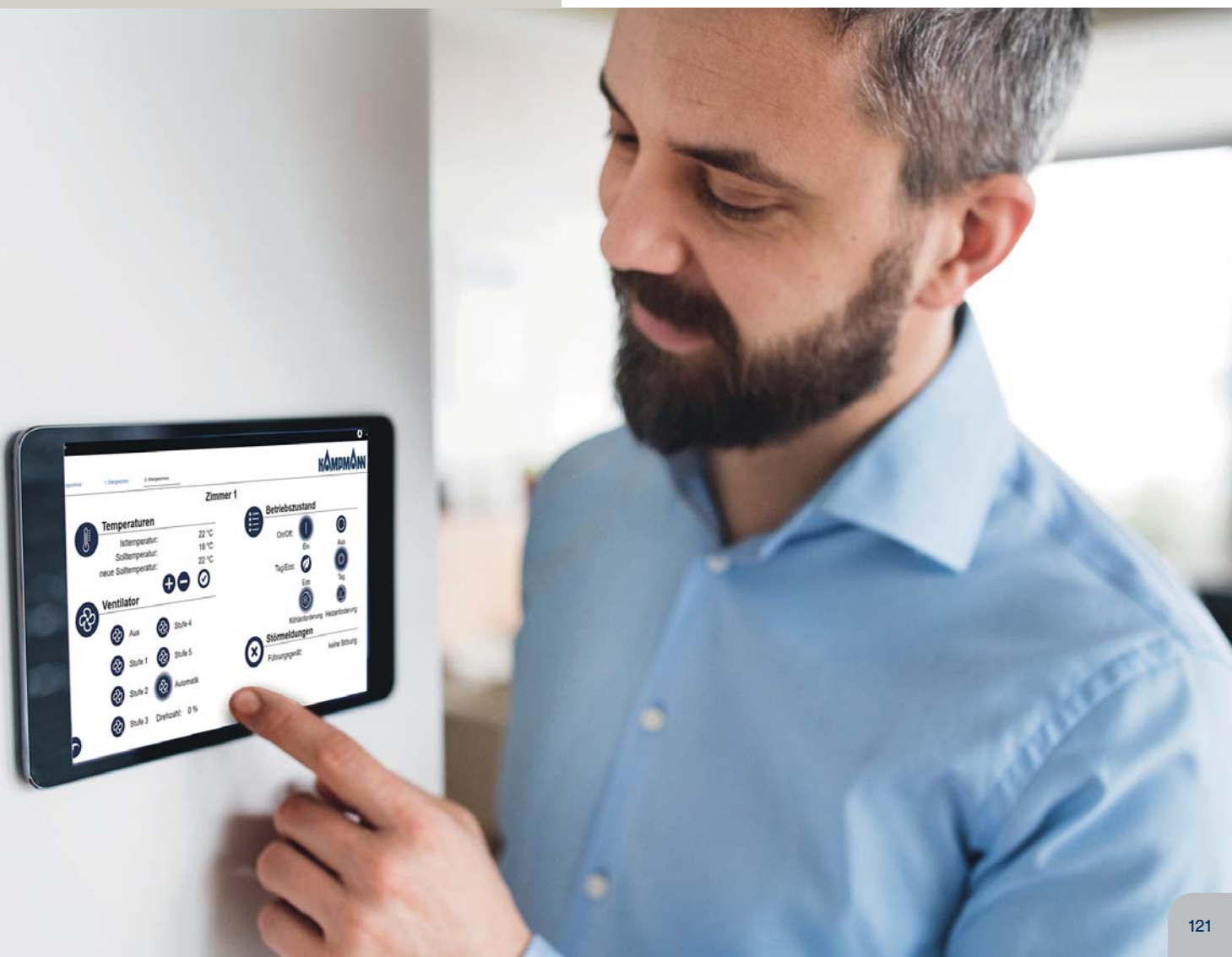

# Our controllers at a glance

## Electromechanical room control units



- > all basic heating and cooling functions for 2- and 4-pipe applications
- > available as different versions, for example with:
  - switching input for setback mode via presence detector or window contact
  - Modbus-RTU interface to automation networks
  - integrated timer function
  - integration into many common flush-mounted ranges

## KaControl



- > the standard for the operation of decentralised units for heating and cooling e.g.:
  - fan coils
  - trench convectors
  - unit heaters
  - optional: gateways for Modbus, KNX, BACnet

## KaControl system controller



- ### SEL secondary air control panel
- > device manager for decentralised local heating/cooling units
  - > controls up to 60 units in up to 25 zones via Modbus RTU
  - > control of the hydraulic secondary circuit, (e.g. pumps and valves)
  - > detection of primary air demand and requirement at air handling system



- ### AUL outside air control panel
- > universal regulation for ventilation systems
  - > all control functions are pre-programmed and can be parametrised project-specifically
  - > various CO<sub>2</sub> control strategies and air volume controls
  - > integration of up to 60 secondary units in up to 10 zones

# Intuitive for users

## KaController room control unit



Our KaController devices are the standard for the operation of decentralised units for heating and cooling, such as fan coils, trench heaters and unit heaters.

They are available in different versions with side buttons or discreet rotary dial operation.

**KaController devices can act as room control units within a complex building control system or can also control stand-alone solutions limited to the room.**

KaControllers enable the system to have key automated control functions. Whether a **window contact control** or integration within a hotel room with **guest card activation**. In addition, KaControllers detect the **supply temperature** and process this information for efficient heating or cooling operation.



# Perfectly choreographed

## KaControl SEL secondary air control panel

The KaControl SEL secondary air control panel is our star choreographer for the perfect interaction of chillers and heat generators, decentralised units for heating and cooling, as well as system hydraulics. It monitors up to 60 units for heating and cooling in up to 25 control zones and is thus THE system solution for heating, cooling and ventilation management.

But it can do more: the control panel provides a variety of functions for the hydraulic integration of our units, the control of pumps and valves in the hydraulic secondary circuit and its control. As the hub of the system solution, the KaControl SEL secondary air control panel ensures an efficient overall system. Sounds complicated? It isn't!

**We offer a fully preconfigured system control and parametrisation during commissioning for ease of start-up.**



# Get started straight away

## KaControl AUL outside air control panel



**The KaControl AUL outside air control panel is our control standard for ventilation systems.** It combines the building services from the generator to the room control to a system and, at the same time, gets the optimum energy efficiency out of your building concept.

And best of all: you're ready to go straight away with our KaControl AUL outside air control panel. **All the relevant control functions for ventilation systems are already fully programmed.** All you have to do is set up the parameters for your individual system – saving you time and costs throughout the entire project.

And, of course, you will receive a complete functional test and instruction from our Kampmann Service team.

# Made-to-measure and intuitive

KaControl visualisation



KaControl visualisation offers ONE central interface for the control and monitoring of our air conditioning systems. And one that's intuitive and easy to use, even if you're not a techie.

**It maps a host of system-relevant functions for heating and cooling, change of operating mode, central shifting of setpoints and timer programs.**

It also displays trend data and central alarm management.

Up to 300 units can be integrated – optionally each complemented by a KaControl room control unit.

KaControl visualisation is always custom-made. **It can be used as a stand-alone control system or as part of a higher-level building automation system.** It is also possible to release sub-functions for certain users.

# Perfectly solved

Kampmann automation specialists have the right solution for every project and optimise the system to suit the respective application. Support starts at the quotation stage: **We define the system to ensure that it precisely meets your requirements.** Alongside the network topology, the design drawings to set up the communication network, such as cabling diagrams, wiring diagrams and parameter lists, are also created.

## We'll arrange it all

Our technical ICA team is available to you for the following:

- > support with the integration of products into established automation standards
- > advice on the selection of various control and automation systems
- > support in decision-making about the scope of automation based on objective assessment criteria
- > operator and user-orientated advice based on efficiency criteria (cost/benefit)
- > support in the integration or linking of our systems into existing building automation systems
- > direct consultation with measurement, control and regulation companies to clarify interfaces to our systems
- > integral control concepts for the functional combination of Kampmann and NOVA units

# We are always there to help!

We will support you through every phase of your project in line with our aim to be the market leader. Our tightly connected network of employees from Sales, Service and Kampus is on hand to deliver our exceptional service levels.

At one of our sites, at your premises, on site or digitally.

[kampmanngroup.com/service](https://kampmanngroup.com/service) →



**Achieve success faster with the technical expertise of the Kampmann Kampus behind you.**

The Kampmann Kampus has been offering a range of technical seminars on heating, cooling, ventilation, as well as building services, control and system solutions in Germany, Austria and Switzerland since 2012. We also offer a series of different workshops on customer management and marketing.

## Project support

Precision and speed.



Wherever you are. We have a wide range of tools to support you in your design: smart apps and calculations programs, BIM data and CAD drawings.

## Customer Service

Take advantage of our nationwide customer service network.

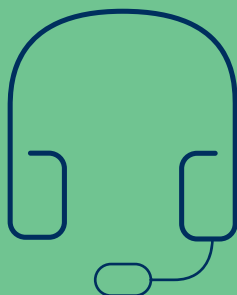

The Customer Service department of the Kampmann Group ensures that our customers are satisfied throughout the entire After-sales Service process. We offer you flexible options to express your concerns and quickly complete your processes.

## Tools

We use these tools in our project planning.

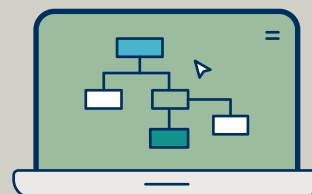

Our website offers a host of time-saving website tools, such as our calculation program, watch list and our individual specification and tender descriptions. Watch our application videos for a quick overview or get started directly – for fast, easy working.

[kampmanngroup.com/service/tools](https://kampmanngroup.com/service/tools)



# The Kampmann Group: unique solutions expertise for the best air conditioning systems.

With over 1000 employees at 16 sites around the world, Kampmann is one of the major players in the construction and building services sector.

The Kampmann and NOVA brands offer solutions expertise and a unique broad-based product range under this umbrella brand.

Our systems for heating, cooling and ventilation are at the forefront of different market segments today.





1000  
+

employees working for  
you at the Kampmann  
Group.

# 21,893

variants of our products in our  
standard range alone.



## International sites



## Headquarters

Kampmann GmbH & Co. KG  
Lingen (Ems), Germany



- > Canada/USA
- > France

- > Italy
- > Netherlands

- > Austria
- > Poland

- > Switzerland
- > Great Britain

# Research & Development Playground

The Kampmann Research and Development Centre (FEC) is a veritable playground for our physicists and engineers. And it also provides the necessary testing ground for our system-based new product and product development processes.

The unprecedented range of laboratories, test stands and premises within the FEC enables our employees to practise their academic expertise in elaborate measurements and simulations. They maintain the high quality standards that our Kampmann customers have come to expect. The Research and Development Centre has therefore provided us with a boost for our innovative prowess time and time again.





[kampmanngroup.com/fec](https://kampmanngroup.com/fec) →



## The Airflow Lab

For real simulation of the air conditioning of rooms: the walls, floor and ceiling can be heated and cooled independently of each other.

## The System Rooms

The two system rooms reproduce a two-axis and a three-axis office. Customer projects can be replicated and measured in them, or product demonstrations arranged.

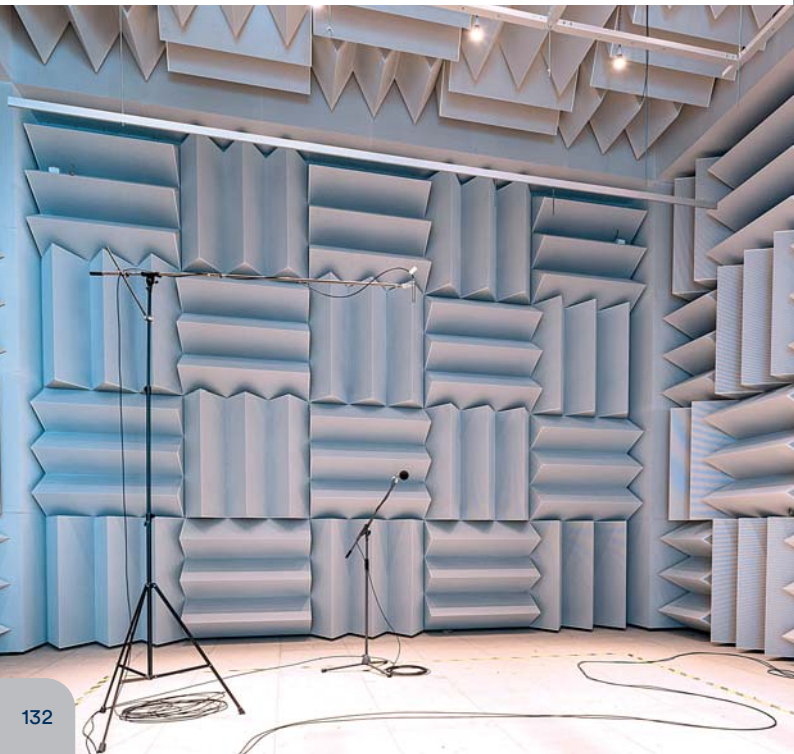

## The Acoustic Measurement Lab

Ssssh! 300 mm of concrete, 400 mm of stone and glass wool as well as 450 mm pyramid acoustic foam in the sound measurement laboratory guarantee absolute silence.



## The Multi-purpose Lab

The heart of the multi-purpose laboratory is the test rig for the standard-compliant measurement of fan and resistance characteristic lines, as well as filters, baffles and ducts.

## The Industrial Tower

The Industrial Tower is where we demonstrate the momentum of our units: depending on the setting, warm air reaches floor level with ease, and cold air is evenly distributed under the ceiling to then fall gently and draught-free.



## The Reverberation Room

As impressive as it is to enter the anechoic sound measurement laboratory with its almost oppressive silence, entering the Reverberation Room is quite the opposite: sound waves are constantly reflected on the acoustically hard wall surfaces, none of which are parallel to their opposite wall.

# Genau mein Klima

## Our Sustainability Strategy

Taking responsibility and acting sustainably. That is our aim in all our business activities. While it is our core business is to ensure a good indoor climate with modern air conditioning units, we also see the need as a company to make our contribution to achieving climate targets, such as the 1.5 degree target set by the Paris Climate Agreement.

We do this through increasingly sustainable products and by operating our sites as ecologically as possible, for example by using climate-neutral gas and electricity.

As an Emsland-based family-owned company, we also feel strongly connected to our location and our local people. Here too, we take responsibility from a sense of conviction – along our supply chain, for our employees and the society in which we operate.

*“Sustainability is more than just a tiresome legislative duty: Sustainability also means safeguarding the future of the company with satisfied and motivated employees, and with a future-centric and fair business strategy. But also by achieving climate targets.”*

Hendrik Kampmann, Managing Director



# Four pillars of sustainability

As part of our sustainability strategy, we have addressed the economic, ecological and social factors of sustainability. In order to further highlight the outstanding role of our employees, we have further sub-divided the social issues. From the three central pillars of sustainability, we thus made Kampmann's four pillars of sustainability. In line with our core business, they are:



## Ecoclimate

- + Business ecology
- + Product ecology
- + Sustainable self-image

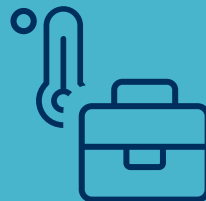

## Working climate

- + Motivated employees
- + New Work
- + Job security

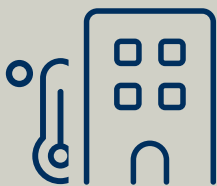

## Corporate Climate

- + Governmental Compliance
- + Risk/Opportunity Management
- + Supply Chain



## Social Climate

- + Social commitment



## Responsibility in the supply chain

Partnering with customers and suppliers is a key factor for our success. Binding guidelines and conduct that are in line with our values are therefore of particular importance.

For Kampmann, responsibility does not start with its own production sites. We therefore attach great importance to transparency and a high proportion of regional suppliers.

### Regionality of our supply chain

Lower Saxony	22.7%
Germany	63.1%
EU	84.8%
Europe	94.2%

## The carbon footprint of our products

Environmental Product Declarations (EPDs) provide information about the environmental impact of a product.

EPDs are standardised and verified so that they can be used as evidence in certification processes for sustainable buildings etc.

We are constantly working to expand our broad-based product range to include new EPDs. We currently offer them for our Katherm HK, Katherm NK and Katherm QK trench heaters and for all sizes of Venkon fan coils.

You can obtain material-based LCA data on request for all fan coil units.



**EPD**<sup>®</sup>  
THE INTERNATIONAL EPD<sup>®</sup> SYSTEM

**DGNB** Product listed  
**Navigator**



# And that's in our Environmental Product Declarations (EPDs)

Our audit does not end with the life cycle of a product. The ongoing use or recycling of products after their original use is also taken into account in our life cycle assessments: from cradle to cradle. This gives you an end-to-end picture of the cycle that our trench technology unit heaters, fan coils etc. go through.

## Manufacturing phase



Supply of raw materials



Transport of raw materials



Production

## Construction phase



Transport of products



Installation

## Usage phase



Maintenance



Repair



Replacement of components



Energy usage

## Disposal phase



Demolition/removal



Transport of waste



Waste treatment



Disposal/recycling



**Kampmann GmbH & Co. KG**  
Friedrich-Ebert-Str. 128-130  
49811 Lingen (Ems)  
Germany

+ 49 591 7108-660  
info@kampmanngroup.com

[kampmanngroup.com](https://kampmanngroup.com)

