



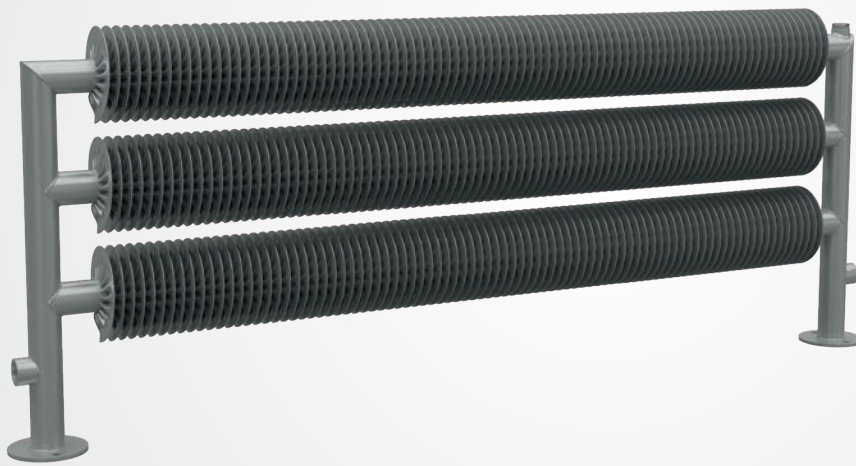
**SPIRAL**



**Finned tube radiators**

# Spiral

The history of finned tube radiators goes back a long time. They first began to appear in factories, warehouses, greenhouses, gyms and laundries. Nowadays, we can also encounter them in office buildings, hallways, restaurants as well as in our homes. Contemporary architecture, filled with new shapes and novel solutions, has allowed the introduction of this industrial element into our immediate vicinity. The possibilities in terms of size, mounting and colour designs will expand the imagination and reinforce the space's uniqueness. Break loose from conventional standards and give originality a chance. Thanks to the thick-walled tube with fins, you will obtain a product with a very long service life. Spiral radiators are suitable for both horizontal and vertical mounting. Coupled with the colour design options, they provide an aesthetic addition to the interior.



△ Spiral RAT3-S



△ Spiral RAO2-V

## Basic specifications

Material	strip steel coiled on a thick-walled steel pipe
Models	RA1, RAT2, RAT3, RAO2, RAO3
Tube × fin diameter	Ø32×92 mm, Ø57×137 mm, Ø76×156 mm Ø89×169 mm, Ø108×188 mm
Length	<b>500–6 000 mm</b> horizontal <b>500–2 500 mm</b> vertical (in step 100 mm, from 3 000 mm in step 200 mm)
Horizontal mounting	floor and wall
Vertical mounting	wall
Base colour	snow white RAL 9016 (colour code - 01)
Additional colours	as per ISAN and the basic RAL colour charts

## Operating conditions

Max. operation overpressure	1,0 MPa
Max. operation temperature	120 °C
Connection thread	inner G1/2"
Heating system	with forced circulation
Ambient conditions	ambient temperature +2 to +40 °C relative humidity 20-70%

## Modifications

Stainless steel (Ø 32×92, Ø 57×137, Ø 76×156 mm models)  
Galvanized (all models)

## Atypical configurations

different connection threads, alternative connection position, denser or thinner finning, additional strands (e.g. RAT4), etc.

*An attractive helix :-)*



△ Spiral RAO4-W atypical

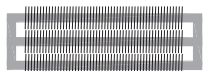
### Horizontal models



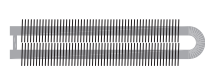
RA1



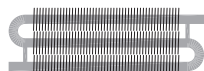
RAT2



RAT3



RAO2

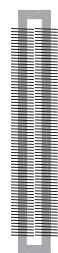


RAO3

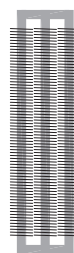
### Vertical models



RA1



RAT2



RAT3



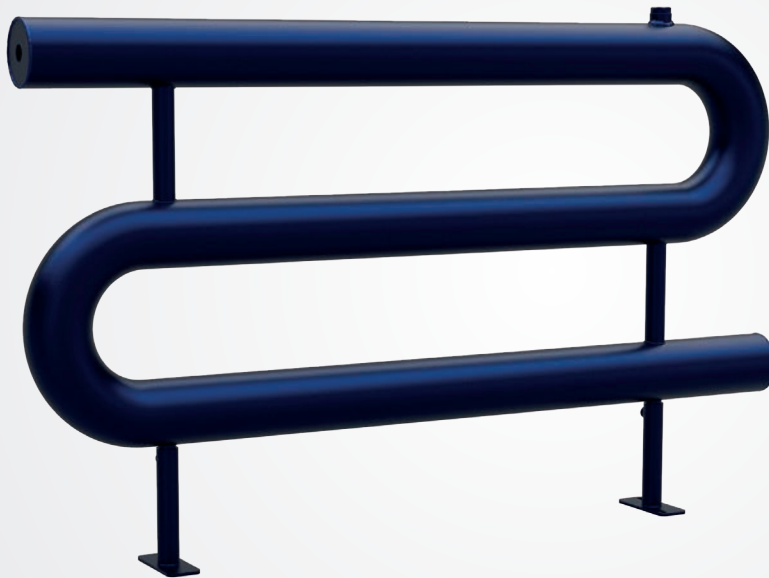
RAO2



RAO3

# Spiral without fins

Minimalism and subtle beauty. Heat-emitting tubes welded in square or S-shaped patterns. The heat produced by the tubes alone may not seem like much, but it is more than enough. This discreet solution is especially popular in corridors, halls, waiting rooms, staircases, wine cellars, restaurants, and even in low-energy and passive houses. It is particularly well suited for heating warehouses and areas where safety requirements are of greater concern, such as in horse stables or other farm buildings. The robust thick-walled pipes guarantee a long service life, making the investment worthwhile.



△ Spiral HRA03-F



△ Spiral HRAT3-V

## Basic specifications

Material	a thick-walled steel pipe
Models	HRA1, HRAT2, HRAT3, HRAO2, HRAO3
Tube diameter	Ø32 mm, Ø57mm, Ø76 mm Ø89 mm, Ø108 mm
Length	<b>500–6 000 mm</b> horizontal <b>500–2 500 mm</b> vertical (in step 100 mm, from 3 000 mm in step 200 mm)
Horizontal mounting	floor and wall
Vertical mounting	wall
Base colour	snow white RAL 9016 (colour code - 01)
Additional colours	as per ISAN and the basic RAL colour charts

## Operating conditions

Max. operation overpressure	1,0 MPa
Max. operation temperature	120 °C
Connection thread	inner G1/2"
Heating system	with forced circulation
Ambient conditions	ambient temperature +2 to +40 °C relative humidity 20-70%

## Modifications

Stainless steel (Ø 32, Ø 57, Ø 76 mm)  
Galvanized (all models)

## Atypical configurations

different connection threads, alternative connection position, denser or thinner finning, additional strands (e.g. HRAT4), etc.

*Give subtlety a chance*



△ Spiral HRAO2-W

### Horizontal models



HRA1



HRAT2



HRAT3



HRAO2



HRAO3

### Vertical models



HRA1



HRAT2



HRAT3



HRAO2



HRAO3

# Stainless steel design

## Models Ø32, Ø57, Ø76

### MODERN INTERIOR DESIGN ELEMENTS

Stainless steel radiators are designed for modern interiors, for premises with requirements for environmental resistance and durability. They are an important part of the room, a massive metal body with gently blasted finish and visible welds.

### WET ENVIRONMENT

Stainless steel coils are suitable for rooms with higher humidity and in the environment where the radiator comes into contact with the water and steam. The material is waterproof and in the longterm period retains the functional characteristics and appearance. Not suitable for aggressive environments with an increased share of chlorine, salt water, etc.

### RESISTANCE

Excellent mechanical properties of stainless steel are a prerequisite for the resistance against abrasion, scratches and mechanical damage. Used stainless steel material also serves as a protection against corrosion. If the conditions for the operation of the body are complied with the life is almost unlimited.

### MATERIAL

The radiator body is made of stainless steel ČSN 17240 (DIN 1.4301, AISI 304). The body surface is finely sanded.

### HEATING OUTPUT

Consider the heating output of the Spiral stainless steel radiators 35% lower than with standard painted steel bodies.

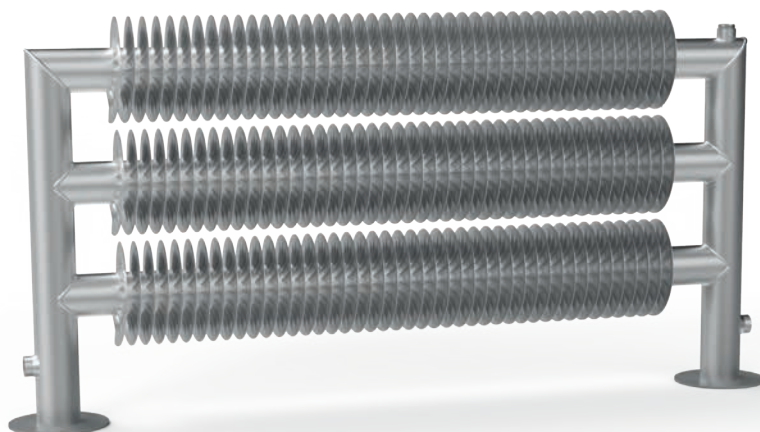
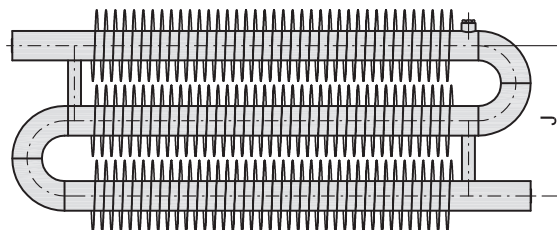


### DESIGN

Types of radiators RAO2, RAO3 in the stainless steel design have a different pitch of "J" finned tubes compared to the standard design, see the table:

### Distance J [mm] of types RAO2, RAO3

Type of Spiral	Painted steel	Stainless steel
RAO2 Ø57 mm	145 mm	175 mm
RAO2 Ø76 mm	200 mm	195 mm
RAO3 Ø57 mm	290 mm	350 mm
RAO3 Ø76 mm	400 mm	390 mm



△ Spiral RAT3-S

# Galvanized design

## All variants

### THE RADIATOR IN THE AGGRAVATED ENVIRONMENT

The hot-dip galvanizing finish is suitable for environments with the difficult environmental conditions. By immersing in the zinc bath with the temperature of 450–470°C, the high quality zinc coating is applied to the steel body. This can long withstand the adverse effects of the surroundings and is resistant to mechanical wear.

#### The galvanized surface is characterized by the following properties:

- long life
- non-porous uniform surface
- high quality and uniform coating, even on the inside and hard to reach areas

This all while meeting the criteria of the environmental standards

### MOIST AND AGGRESSIVE ENVIRONMENTS

Galvanizing resists aggravated environmental conditions when used in areas where it is exposed to water, steam, frost, ammonia and other aggressive substances.

- aggressive environment (farm buildings, piggeries, ...)
- open spaces (halls, stadiums ...)
- exposed premises (boiler rooms, manufacturing plants)

### RESISTANCE

Galvanized finish is resistant to mechanical damage. It is suitable for manufacturing plants, commercial buildings and wherever it is within the operation and handling possible that the body will be subjected to abrasion or impacts.

### HEATING OUTPUT

Consider the heating output of Spiral galvanized radiators being 10 % lower than standard painted steel bodies.

### CONS – APPEARANCE AND DESIGN ADJUSTMENT

The technology of applying the zinc coating by dipping in hot metal bath entails several disadvantages. The surface is not completely smooth; it may contain surface roughness (meal). There may be burrs caused by sagging zinc along the perimeter. Structurally, it is necessary to provide the radiator with additional couplings (securing inlet, outlet and venting openings). The zinc layer is also inside the radiator.

The production itself is always preceded by drawing to be confirmed by the customer.

The final radiator is shipped roughly deburred whereas additional lugs are blinded and connecting threads are stretched.

### Spiral Radiators with the galvanized coating are supplied with these connecting threads:

Connecting threads	
<b>G 3/4"</b>	for Spiral Ø32×92 mm
<b>G1"</b>	for Spiral Ø57×137, Ø76×156, Ø89×169, Ø108×188 mm

Including galvanized reductions for thread G1/2"



### DESIGN

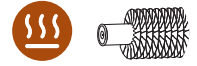
Spiral radiator with the hot-dip zinc is not primarily intended for use in residential interiors, unless explicitly intended by the architect, who accepts the surface roughness of the product. It is more suitable to commercial premises.



△ Spiral RAO2-V



# Spiral Horizontal heating output

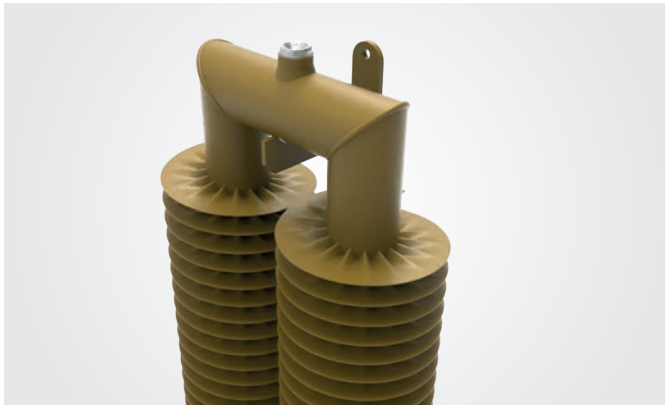


Type	Model	n [-]	Temperature gradient $\Delta T$ [K]	Length [mm] / Heating output [W]								
				500	1000	1500	2000	2500	3000	4000	5000	6000
RA1	Ø32x92 mm	1,3062	$\Delta T30$	70	144	219	296	374	453	611	772	933
			$\Delta T50$	136	280	427	577	729	882	1191	1504	1819
			$\Delta T60$	173	355	542	732	925	1119	1511	1908	2308
	Ø57x137	1,2931	$\Delta T30$	89	184	281	380	480	580	784	990	1197
			$\Delta T50$	173	356	544	735	929	1123	1518	1916	2318
			$\Delta T60$	219	451	689	930	1176	1422	1922	2425	2934
	Ø76x156	1,2876	$\Delta T30$	97	201	307	415	524	634	857	1082	1309
			$\Delta T50$	188	388	593	801	1012	1224	1654	2088	2526
			$\Delta T60$	238	491	750	1013	1280	1548	2092	2640	3194
	Ø89x169	1,2162	$\Delta T30$	102	211	330	458	590	727	1010	1300	1600
			$\Delta T50$	190	393	615	852	1099	1354	1879	2419	2978
			$\Delta T60$	237	491	768	1064	1372	1690	2345	3020	3717
Ø108x188	1,217	$\Delta T30$	105	223	351	485	626	771	1070	1378	1697	
		$\Delta T50$	195	415	653	904	1166	1436	1993	2566	3159	
		$\Delta T60$	243	518	815	1129	1456	1793	2488	3203	3944	
RA2	Ø32x92 mm	1,2831	$\Delta T30$	113	241	376	516	659	804	1102	1408	1718
			$\Delta T50$	218	465	725	994	1269	1549	2123	2711	3309
			$\Delta T60$	275	588	916	1256	1603	1957	2683	3426	4181
	Ø57x137	1,2795	$\Delta T30$	148	316	493	676	863	1053	1443	1843	2250
			$\Delta T50$	285	608	948	1299	1659	2025	2775	3543	4325
			$\Delta T60$	360	768	1197	1640	2095	2557	3504	4474	5461
	Ø76x156	1,278	$\Delta T30$	164	350	546	748	955	1166	1598	2041	2491
			$\Delta T50$	315	673	1049	1437	1835	2240	3070	3920	4786
			$\Delta T60$	398	850	1324	1814	2316	2828	3876	4949	6042
	Ø89x169	1,2537	$\Delta T30$	180	385	600	822	1049	1281	1756	2242	2737
			$\Delta T50$	342	730	1138	1559	1991	2431	3331	4253	5192
			$\Delta T60$	430	917	1430	1959	2502	3055	4186	5345	6525
Ø108x188	1,2581	$\Delta T30$	194	414	645	884	1129	1378	1888	2411	2944	
		$\Delta T50$	368	787	1227	1681	2146	2621	3591	4585	5598	
		$\Delta T60$	463	990	1543	2114	2699	3297	4517	5767	7041	
RA3	Ø32x92 mm	1,2788	$\Delta T30$	156	333	519	711	908	1108	1519	1939	2368
			$\Delta T50$	299	640	997	1366	1745	2130	2919	3726	4550
			$\Delta T60$	378	808	1259	1725	2203	2689	3685	4704	5745
	Ø57x137	1,2736	$\Delta T30$	208	443	691	946	1209	1475	2022	2582	3152
			$\Delta T50$	398	849	1324	1814	2317	2828	3876	4948	6041
			$\Delta T60$	502	1071	1670	2288	2923	3567	4889	6241	7620
	Ø76x156	1,2711	$\Delta T30$	231	494	771	1055	1348	1646	2255	2878	3515
			$\Delta T50$	443	946	1475	2020	2580	3150	4316	5510	6728
			$\Delta T60$	559	1193	1860	2547	3253	3972	5442	6947	8483
	Ø89x169	1,2745	$\Delta T30$	246	525	818	1120	1430	1747	2393	3056	3731
			$\Delta T50$	471	1006	1568	2148	2743	3349	4589	5860	7155
			$\Delta T60$	594	1269	1978	2710	3461	4225	5789	7393	9027
Ø108x188	1,2811	$\Delta T30$	267	571	890	1219	1557	1901	2604	3325	4060	
		$\Delta T50$	514	1098	1712	2346	2995	3657	5011	6398	7811	
		$\Delta T60$	649	1387	2162	2963	3783	4619	6329	8081	9866	
RAO2	Ø32x92 mm	1,2786	$\Delta T30$	111	229	350	472	596	721	974	1230	1488
			$\Delta T50$	213	440	672	907	1146	1386	1872	2364	2860
			$\Delta T60$	269	556	848	1145	1447	1750	2363	2985	3611
	Ø57x137	1,2511	$\Delta T30$	147	304	464	628	792	958	1295	1635	1978
			$\Delta T50$	279	576	880	1189	1501	1816	2454	3098	3748
			$\Delta T60$	350	724	1105	1494	1886	2281	3083	3892	4708
	Ø76x156	1,2296	$\Delta T30$	179	369	564	762	962	1164	1572	1985	2402
			$\Delta T50$	335	692	1057	1428	1803	2181	2946	3720	4501
			$\Delta T60$	419	866	1323	1787	2256	2729	3686	4655	5632
	Ø89x169	1,2264	$\Delta T30$	182	364	567	785	1013	1250	1734	2231	2748
			$\Delta T50$	340	681	1061	1469	1896	2338	3245	4175	5142
			$\Delta T60$	425	852	1327	1837	2371	2924	4058	5221	6430
Ø108x188	1,2298	$\Delta T30$	188	410	647	896	1156	1422	1974	2542	3129	
		$\Delta T50$	352	768	1212	1680	2166	2666	3699	4765	5864	
		$\Delta T60$	440	961	1517	2102	2710	3336	4629	5963	7338	
RAO3	Ø32x92 mm	1,2511	$\Delta T30$	150	310	474	640	809	978	1322	1668	2019
			$\Delta T50$	285	588	898	1213	1532	1854	2504	3161	3825
			$\Delta T60$	358	739	1128	1524	1925	2329	3146	3971	4805
	Ø57x137	1,209	$\Delta T30$	204	421	643	869	1097	1328	1794	2264	2740
			$\Delta T50$	378	781	1193	1612	2035	2462	3326	4199	5081
			$\Delta T60$	471	974	1487	2010	2537	3069	4146	5235	6334
	Ø76x156	1,1716	$\Delta T30$	244	503	768	1038	1311	1586	2143	2705	3273
			$\Delta T50$	444	915	1398	1889	2385	2886	3898	4922	5955
			$\Delta T60$	550	1133	1731	2339	2953	3573	4826	6094	7373
	Ø89x169	1,2365	$\Delta T30$	-	506	802	1112	1434	1763	2445	3152	3878
			$\Delta T50$	-	951	1508	2092	2696	3316	4599	5928	7293
			$\Delta T60$	-	1191	1889	2621	3378	4155	5762	7427	9137
Ø108x188	1,2426	$\Delta T30$	-	594	942	1306	1683	2071	2872	3701	4554	
		$\Delta T50$	-	1120	1777	2464	3175	3907	5418	6983	8591	
		$\Delta T60$	-	1405	2229	3091	3982	4900	6796	8759	10775	

Temperature gradient  $\Delta T30 = 55/45/20$  °C,  $\Delta T50 = 75/65/20$  °C,  $\Delta T60 = 90/70/20$  °C  
 See pages 20-23 for detailed heating outputs for all lengths.

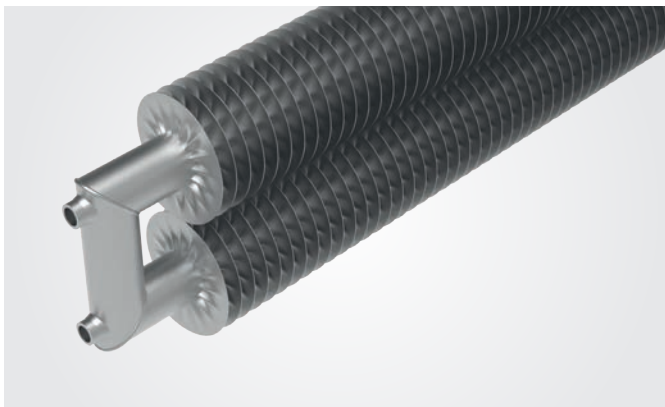


# Indicative heating outputs of the Spiral modifications



## Spiral Vertical

The heating output of the vertical Spiral models is about 30 % lower than that of horizontal units.



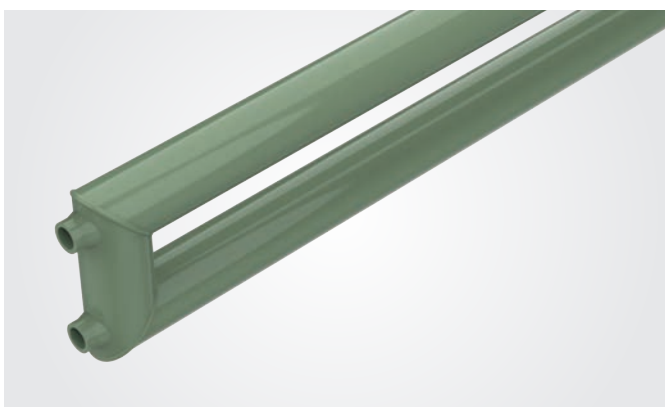
## Stainless-steel Spiral

The heat output of stainless-steel models is about 35 % lower than that of conventional steel units.



## Galvanized zinc Spiral

The heating output of galvanized zinc models is about 10 % lower than that of conventional steel units.



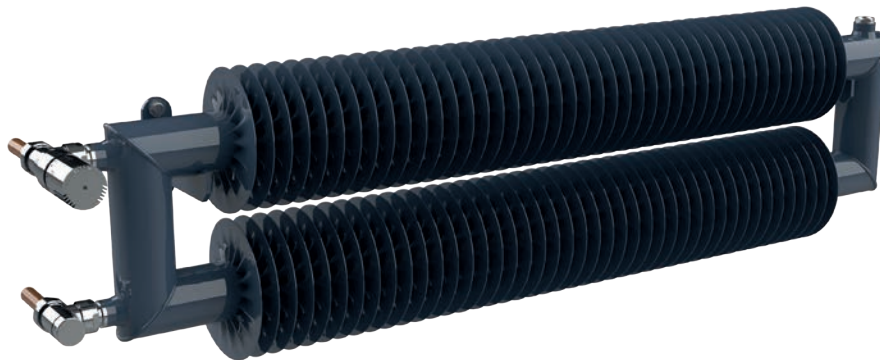
## Spiral without fins

The heating output of models without the ribbing is about 60-80 % lower than that of standard design units.

Ø 32	<b>-80 %</b>	Ø 57	<b>-75 %</b>
Ø 76	<b>-70 %</b>	Ø 89	<b>-65 %</b>
Ø 108	<b>-60 %</b>		

The output reduction of the Spiral modification is multiplied when the designs are combined. E.g. the galvanized Spiral Vertical output = the horizontal output x 0,7x0,9.

# Thermostatic Packs

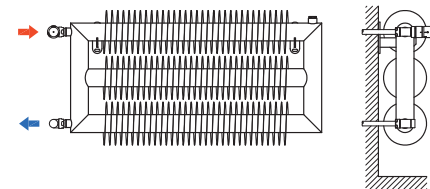


## Thermostatic set corner

white  
chrome  
inox



illustration image



### Pack no. 113 / white / Code: O37BRC-113

Connection to copper pipes  $\varnothing$  15 mm

Thermostatic head / white  
Corner thermostatic valve and lockshield valve / white  
Clamping fittings for copper pipes / chrome

### Pack no. 115 / chrome / Code: O37CRC-115

Connection to copper pipes  $\varnothing$  15 mm

Thermostatic head / chrome  
Corner thermostatic valve and lockshield valve / chrome  
Clamping fittings for copper pipes / chrome

### Pack no. 117 / inox / Code: O37NRC-117

Connection to copper pipes  $\varnothing$  15 mm

Thermostatic head / inox  
Corner thermostatic valve and lockshield valve / inox  
Clamping fittings for copper pipes / inox

### Pack no. 114 / white / Code: O37BRA-114

Connection to Al/PEX, Al/PERT pipes  $\varnothing$  16 $\times$ 2 mm

Thermostatic head / white  
Corner thermostatic valve and lockshield valve / white  
Clamping fittings for Al/PEX and Al/PERT / chrome

### Pack no. 116 / chrome / Code: O37CRA-116

Connection to Al/PEX, Al/PERT pipes  $\varnothing$  16 $\times$ 2 mm

Thermostatic head / chrome  
Corner thermostatic valve and lockshield valve / chrome  
Clamping fittings for Al/PEX and Al/PERT / chrome

### Pack no. 118 / inox / Code: O37NRA-118

Connection to Al/PEX, Al/PERT pipes  $\varnothing$  16 $\times$ 2 mm

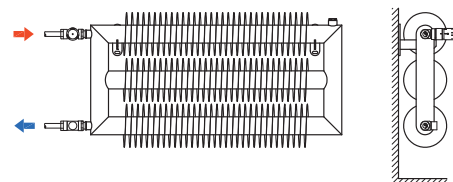
Thermostatic head / inox  
Corner thermostatic valve and lockshield valve / inox  
Clamping fittings for Al/PEX and Al/PERT / inox

## Thermostatic set direct

white  
chrome  
inox



illustration image



### Pack no. 107 / white / Code: O37BPC-107

Connection to copper pipes  $\varnothing$  15 mm

Thermostatic head / white  
Direct thermostatic valve and lockshield valve / white  
Clamping fittings for copper pipes / chrome

### Pack no. 109 / chrome / Code: O37CPC-109

Connection to copper pipes  $\varnothing$  15 mm

Thermostatic head / chrome  
Direct thermostatic valve and lockshield valve / chrome  
Clamping fittings for copper pipes / chrome

### Pack no. 111 / inox / Code: O37NPC-111

Connection to copper pipes  $\varnothing$  15 mm

Thermostatic head / inox  
Direct thermostatic valve and lockshield valve / inox  
Clamping fittings for copper pipes / inox

### Pack no. 108 / white / Code: O37BPA-108

Connection to Al/PEX, Al/PERT pipes  $\varnothing$  16 $\times$ 2 mm

Thermostatic head / white  
Direct thermostatic valve and lockshield valve / white  
Clamping fittings for Al/PEX and Al/PERT / chrome

### Pack no. 110 / chrome / Code: O37CPA-110

Connection to Al/PEX, Al/PERT pipes  $\varnothing$  16 $\times$ 2 mm

Thermostatic head / chrome  
Direct thermostatic valve and lockshield valve / chrome  
Clamping fittings for Al/PEX and Al/PERT / chrome

### Pack no. 112 / inox / Code: O37NPA-112

Connection to Al/PEX, Al/PERT pipes  $\varnothing$  16 $\times$ 2 mm

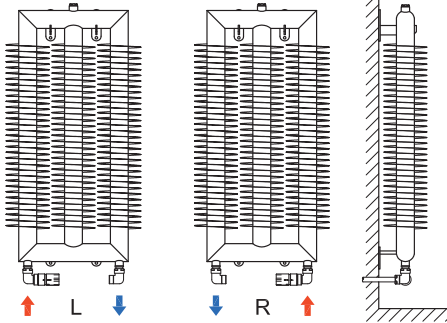
Thermostatic head / inox  
Direct thermostatic valve and lockshield valve / inox  
Clamping fittings for Al/PEX and Al/PERT / inox

## Thermostatic set angular - triax

white  
chrome  
inox

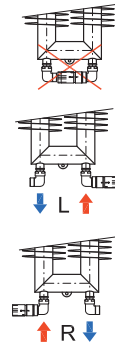


illustration image

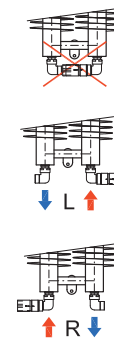


### Models with reverse installation

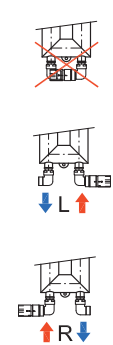
RAT2 Ø32×92  
RAT2 Ø57×137



RAO2 Ø32×92  
RAO2 Ø57×137



HRAT2 Ø32, Ø57  
HRAT2 Ø76, Ø89  
HRAT3 Ø32



**Pack no. 101L / white / left / Code: O37BUCL101**

**Pack no. 101R / white / right / Code: O37BUCR101**

Connection to copper pipes ø 15 mm

Thermostatic head / white

Angular thermostatic valve and lockshield valve / white  
Clamping fittings for copper pipes / chrome

**Pack no. 103L / chrome / left / Code: O37CUCL103**

**Pack no. 103R / chrome / right / Code: O37CUCR103**

Connection to copper pipes ø 15 mm

Thermostatic head / chrome

Angular thermostatic valve and lockshield valve / chrome  
Clamping fittings for copper pipes / chrome

**Pack no. 105L / inox / left / Code: O37NUCL105**

**Pack no. 105R / inox / right / Code: O37NUCR105**

Connection to copper pipes ø 15 mm

Thermostatic head / inox

Angular thermostatic valve and lockshield valve / inox  
Clamping fittings for copper pipes / inox

**Pack no. 102L / white / left / Code: O37BUAL102**

**Pack no. 102R / white / right / Code: O37BUAR102**

Connection to Al/PEX, Al/PERT pipes ø 16×2 mm

Thermostatic head / white

Angular thermostatic valve and lockshield valve / white  
Clamping fittings for Al/PEX and Al/PERT / chrome

**Pack no. 104L / chrome / left / Code: O37CUAL104**

**Pack no. 104R / chrome / right / Code: O37CUAR104**

Connection to Al/PEX, Al/PERT pipes ø 16×2 mm

Thermostatic head / chrome

Angular thermostatic valve and lockshield valve / chrome  
Clamping fittings for Al/PEX and Al/PERT / chrome

**Pack no. 106L / inox / left / Code: O37NUAL106**

**Pack no. 106R / inox / right / Code: O37NUAR106**

Connection to Al/PEX, Al/PERT pipes ø 16×2 mm

Thermostatic head / inox

Angular thermostatic valve and lockshield valve / inox  
Clamping fittings for Al/PEX and Al/PERT / inox

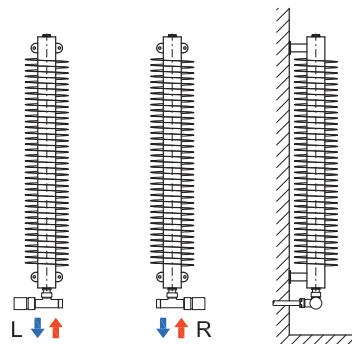
## Thermostatic valve single-point connection corner thermostatic valve

The single-point thermostatic valve is only suitable for vertical models Spiral **RA1** and **HRA1** with a diameter of **ø 57, 76, 89** and **108**, where the internal structure is adapted

white  
chrome  
inox



illustration image



**Pack no. 145L / white / left / Code: O37BWCL145**

**Pack no. 145R / white / right / Code: O37BWCR145**

Connection to copper pipes ø 15 mm

Thermostatic head / white

Corner thermostatic valve and lockshield valve / white  
Clamping fittings for copper pipes / chrome

**Pack no. 147L / chrome / left / Code: O37CWCL147**

**Pack no. 147R / chrome / right / Code: O37CWCR147**

Connection to copper pipes ø 15 mm

Thermostatic head / chrome

Corner thermostatic valve and lockshield valve / chrome  
Clamping fittings for copper pipes / chrome

**Pack no. 149L / inox / left / Code: O37NWCL149**

**Pack no. 149R / inox / right / Code: O37NWC149**

Connection to copper pipes ø 15 mm

Thermostatic head / inox

Corner thermostatic valve and lockshield valve / inox  
Clamping fittings for copper pipes / inox

**Pack no. 146L / white / left / Code: O37BWAL146**

**Pack no. 146R / white / right / Code: O37BWAR146**

Connection to Al/PEX, Al/PERT pipes ø 16×2 mm

Thermostatic head / white

Corner thermostatic valve and lockshield valve / white  
Clamping fittings for Al/PEX and Al/PERT / chrome

**Pack no. 148L / chrome / left / Code: O37CWAL148**

**Pack no. 148R / chrome / right / Code: O37CWAR148**

Connection to Al/PEX, Al/PERT pipes ø 16×2 mm

Thermostatic head / chrome

Corner thermostatic valve and lockshield valve / chrome  
Clamping fittings for Al/PEX and Al/PERT / chrome

**Pack no. 150L / inox / left / Code: O37NWAL150**

**Pack no. 150R / inox / right / Code: O37NWAR150**

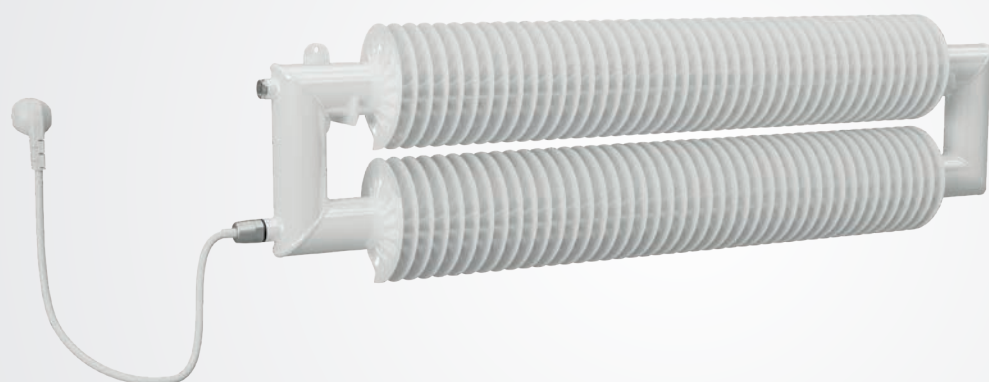
Connection to Al/PEX, Al/PERT pipes ø 16×2 mm

Thermostatic head / inox

Corner thermostatic valve and lockshield valve / inox  
Clamping fittings for Al/PEX and Al/PERT / inox

# Spiral Electro

Electricity is ubiquitous, offering us far more options as to the placement of the “helix”. Spiral Electro is a stand-alone heating unit connected to the mains. Common installation locations include hallways, dressing rooms, garages, workshops, restaurant central pillars, underneath waiting room benches, basically anywhere electricity is available. The distinctive industrial design will add a touch of originality to your interior, while the wide range of available colours will allow you to stylishly incorporate the radiator into the surrounding space. It can be ordered with or without a controller to be connected to your own SMART system.



△ Spiral RAT2-W



△ Spiral RA1-V

## Basic specifications

Material	strip steel coiled on a thick-walled steel pipe, filled with operating fluid and fitted with a heating rod
Models	RA1, RAT2, RAO2
Tube × fin diameter	Ø57×137 mm, Ø76×56 mm
Length	500–2 000 mm (in step 250 mm)
Horizontal mounting	floor and wall
Vertical mounting	wall
Base colour	snow white RAL 9016 (colour code - 01)
Additional colours	as per ISAN and the basic RAL colour charts

## Operating conditions

Operating voltage	230 V AC, 50/60 Hz
Protection	IPX4
Control / regulation	thermostat, regulator or basic without control
Ambient conditions	ambient temperature +2 to +40 °C relative humidity 20-70%

## Control

Rio, Neo, Vision	LCD thermostat with weekly programming
Solo, Mini PW	radiator power regulator
Basic Z heating rod	heating rod without regulation

*Electricity takes the leading role*

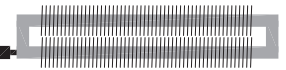


△ Spiral RA02-F

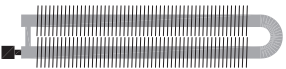
**Horizontal models**



RA1

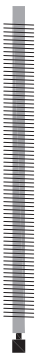


RAT2

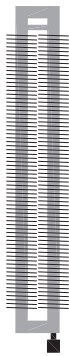


RA02

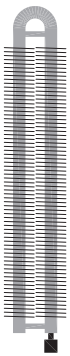
**Vertical models**



RA1



RAT2



RA02

# Spiral Electro heating output

The heating output of electric Spiral units is determined by the power input of the heating rod.

## Max. recommended power input [W]

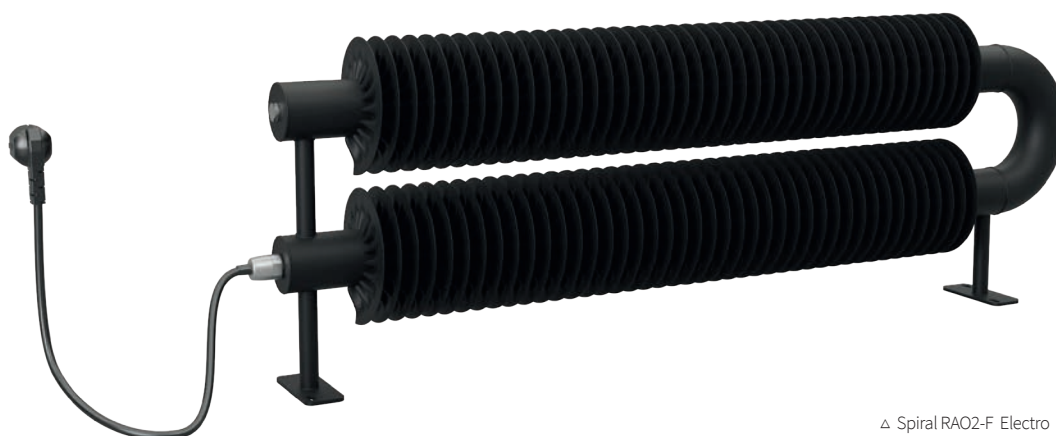
### Vertical models

Type	Model	Length [mm] / Max. recommended power input [W]						
		500	750	1000	1250	1500	1750	2000
RA1	Ø57x137	200	200	300 <sup>1)</sup>	300 <sup>1)</sup>	400	400	500 <sup>2)</sup>
RA1	Ø76x156	200	200	300 <sup>1)</sup>	300 <sup>1)</sup>	400	500 <sup>2)</sup>	600
RAT2, RAO2	Ø57x137	200	300 <sup>1)</sup>	400	500 <sup>2)</sup>	600	700 <sup>3)</sup>	800
RAT2, RAO2	Ø76x156	200	400	500 <sup>2)</sup>	600	700 <sup>3)</sup>	900 <sup>4)</sup>	1000

### Horizontal models

Type	Model	Length [mm] / Max. recommended power input [W]						
		500	750	1000	1250	1500	1750	2000
RA1	Ø57x137	200	300 <sup>1)</sup>	400	400	500 <sup>2)</sup>	600	700 <sup>3)</sup>
RA1	Ø76x156	200	300 <sup>1)</sup>	400	500 <sup>2)</sup>	600	700 <sup>3)</sup>	800
RAT2, RAO2	Ø57x137	300 <sup>1)</sup>	400	600	700 <sup>3)</sup>	900 <sup>4)</sup>	1000	1200
RAT2, RAO2	Ø76x156	300 <sup>1)</sup>	500 <sup>2)</sup>	700 <sup>3)</sup>	900 <sup>4)</sup>	1000	1200	1200

Note: if a rod with the specified power is not available for the selected type of regulation, the nearest lower input power is installed.  
Installed power inputs Nexus series: <sup>1)</sup> 200 W; <sup>2)</sup> 400 W; <sup>3)</sup> 600 W; <sup>4)</sup> 800 W



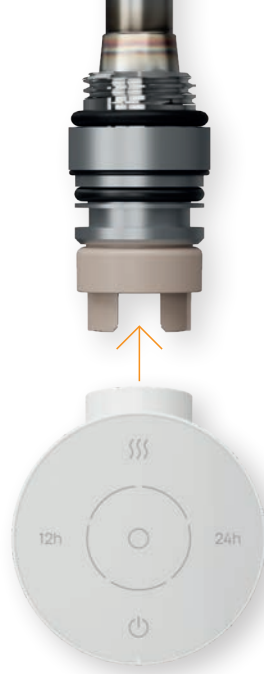
△ Spiral RAO2-F Electro

# Regulators

## Regulators with Nexus system

The innovative heating rod - regulator connection facilitates the replacement of the existing regulator for a new one with a different design or improved functions. Our range includes basic regulators, regulators with advanced functions or Wi-Fi connectivity.

**nexus**  
easy connect



**NEW PRODUCT**

### Benefits



Nexus system heating rod compatibility with any Nexus regulator



quick and easy installation\*

\*Installation may only be performed by qualified persons

## Solo

A basic regulator with Nexus system designed for electric dryers controlled by touch buttons. It supports various operating modes, including timer, boost and antifreeze. The timer activates the heating function every 12 or 24 hours.



Order code: O30-1S000G01-01\_EN

Order code: O30-1S000G80-01\_EN

### Technical data

<b>Operating modes</b>	
· timer 12 h and timer 24 h	· antifreeze
· manual	· lock screen
· stand-by	· factory reset
· boost	
<b>Power range</b>	5 levels adjustable by settings based on electric heating element power capacity
<b>Installation (vertical models)</b>	on the right side (on the left side - must be specified in the order)
<b>Connection system</b>	Nexus
<b>Connection</b>	straight 120 cm electric cable terminated with a plug
<b>Display type</b>	capacitive touchscreen interface
<b>Colour of display</b>	white/black
<b>Colour of regulator</b>	chrome/white
<b>Protection zone</b>	2 and 3
<b>Available heating rods</b>	200 W-1 200 W
<b>Dimensions</b>	61.5 × 70 × 50 mm
<b>Power supply</b>	230 V/ 50 Hz
<b>Protection category</b>	I
<b>Degree of protection</b>	IPX4
<b>Working temperature</b>	0°-40°C
<b>Max humidity level</b>	RH 85% at 25°C (without condensation)

## Rio



A stylish regulator with Nexus system for electric radiators with an easy-to-read backlit LCD display and intuitive control. Its shape lends itself to being used with all designer radiators. Operating modes such as ECO, weekly programming, open window detection and a built-in temperature sensor help reduce heating costs. Available in a WIFI version that allows the regulator to be controlled using a mobile app.



Order code: O30-1S000Q01-01\_EN

Order code: O30-1S000F01-01\_EN (WIFI)

Order code: O30-1S000Q80-01\_EN

Order code: O30-1S000F80-01\_EN (WIFI)

### Technical data

<b>Operating modes</b>	
· comfort	· antifreeze
· ECO	· boost
· weekly program	· keyboard lock
· open window detection	· factory reset
<b>Temperature range of room</b>	+7°C to +25°C
<b>Installation (vertical models)</b>	on the right side (on the left side - must be specified in the order)
<b>Connection system</b>	Nexus
<b>Connection</b>	straight 120 cm electric cable terminated with a plug
<b>Display type</b>	LCD with backlit
<b>Colour of regulator</b>	white/chrome
<b>Protection zone</b>	2 and 3
<b>Available heating rods</b>	200 W-1200 W
<b>Dimensions</b>	61.5 × 70 × 50 mm
<b>Power supply</b>	230 V/ 50 Hz
<b>Protection category</b>	I
<b>Degree of protection</b>	IPX4
<b>Working temperature</b>	0°-40°C
<b>Max humidity level</b>	RH 85% at 25°C (without condensation)
<b>WIFI connection</b>	available WIFI version

## Neo



A stylish regulator with Nexus system for electric radiators with an easy-to-read backlit LCD display and intuitive control. The tilt of the display improves its readability and facilitates operation. Operating modes such as ECO, weekly programming, open window detection and a built-in temperature sensor help reduce heating costs. Available in a WIFI version that allows the regulator to be controlled using a mobile app.



Order code: O30-1S000Y01-01\_EN  
Order code: O30-1S000X01-01\_EN (WIFI)



Order code: O30-1S000Y80-01\_EN  
Order code: O30-1S000X80-01\_EN (WIFI)

---

### Technical data

#### Operating modes

- comfort
- ECO
- weekly program
- open window detection

Temperature range of room

Working temperature

Installation (vertical models)

Connection system

Connection

- antifreeze
- boost
- keyboard lock
- factory reset

+7°C to +25°C

0°–40°C

on the right side

Nexus

straight 120 cm electric cable terminated with a plug

#### Display type

Colour of regulator

Protection zone

Available heating rods

Dimensions

Power supply

Protection category

Degree of protection

Max humidity level

WIFI connection

LCD with backlit

white/chrome

2 and 3

200 W–1 200 W

140 × 66 × 60 mm

230 V/ 50 Hz

I

IPX4

RH 85% at 25°C (without condensation)

available WIFI version



# Other regulators

## Z heating rod

Z heating rod, without a regulator. Standard right lower flow pipe installation. Left-side installation requirement must be specified in the order.



NEW PRODUCT

### Technical data

Working voltage	230 V/50 Hz
Protection category	I
Degree of protection	IP44
Installation (vertical models)	on the right side (on the left - must be specified in the order)
Connection thread	G 1/2" outer
Connection	coiled 120 cm electric cable terminated with a plug
Colour of cable	white/black

## Mini PW

A basic regulator with a dial for controlling the dryer output at a scale of 20 to 100% of the rated output. In the min. position the regulator is OFF, while in the max. position it remains constantly ON.



### Technical data

Working voltage	230 V/50 Hz
Protection category	I
Degree of protection	IPX4
Working temperature	0-50°C
Working humidity	0-85 % (without condensation)
Power range	20-100 % of the nominal output of towel dryer
Installation (vertical models)	on the right side (on the left side - must be specified in the order)
Connection thread	G 1/2" outer (on the heating rod)
Connection	straight 120 cm electric cable terminated with a plug
Colour of regulator	white/chrome
Colour of cable	white/grey
Protection zone	2 and 3
Available heating rods	200 W-1 200 W
Dimensions	65 × 75 × 40 mm

## Vision



NEW PRODUCT

A programmable electrical regulator with a large TFT display. The tilt angle of the display improves its readability and facilitates control. The regulator can be controlled manually or via the Tevolve app from anywhere with Internet access. Operating modes such as ECO, hourly programming or open window detection help cut down on heating costs.



### Gateway

- electric heating controller
- multiple unit control
- energy saving



### Technical data

Operating modes	<ul style="list-style-type: none"> <li>· antifreeze</li> <li>· boost</li> <li>· keyboard lock</li> <li>· factory reset</li> <li>· manual</li> </ul>	Display type	TFT display with backlit
· comfort		Colour of regulator	white / black
· ECO		Protection zone	2 and 3
· weekly program		Available heating rods	200-1 200 W
· open window detection		Dimensions	150 × 70 × 38 mm
Communication radio frequency	868 MHz	Power supply	230 V / 50 HZ
Installation	on the right side	Protection category	I
Connection thread	G1/2" outer (on the heating rod)	Degree of protection	IP44
Connection	straight 120 cm electric cable terminated with a plug	Working temperature	0°-40°C

# Technical part

<b>Spiral radiators heating outputs</b>	<b>19</b>
<b>Reference weigh</b>	<b>24</b>
<b>Reference heating medium volume</b>	<b>27</b>
<b>Spiral mounting</b>	<b>28</b>
<b>Spiral technical drawings</b>	<b>30</b>
Spiral Horizontal – WALL	30
Spiral Horizontal – FLOOR	31
Spiral Horizontal – SELFSTANDING	32
Spiral Vertical – WALL	33
Spiral Horizontal without fins – WALL	35
Spiral Horizontal without fins – FLOOR	36
Spiral Horizontal without fins – SELFSTANDING	37
Spiral Vertical without fins – WALL	38
Spiral Electro Horizontal – WALL	40
Spiral Electro Horizontal – FLOOR	41
Connection options for spiral radiators	42
Next atypical designs of radiators	43
<b>How to order Spiral radiators</b>	<b>44</b>
<b>Colour Reference Chart</b>	<b>46</b>

# Spiral radiators heating outputs

## Spiral Horizontal heating output

Detailed heating outputs of Spiral Horizontal in lengths of 500 - 6000 mm for temperature gradients  $\Delta T = 60$  K,  $\Delta T = 50$  K,  $\Delta T = 42.5$  K,  $\Delta T = 30$  K are shown in the tables on pages 20–23

## Heating output of Spiral modifications

### Spiral Vertical

The heating output of the vertical Spiral models is about 30 % lower than that of horizontal units.

### Stainless-steel Spiral

The heat output of stainless-steel models is about 35 % lower than that of conventional steel units.

### Galvanized zinc Spiral

The heating output of galvanized zinc models is about 10 % lower than that of conventional steel units.

### Spiral without fins

The heating output of models without the ribbing is about 60-80 % lower than that of standard design units.

Ø 32 -80 %    Ø 57 -75 %    Ø 76 -70 %    Ø 89 -65 %    Ø 108 -60 %

## How to calculate the heating output of a combination of Spiral modifications

The output reduction of the Spiral modification is multiplied when the designs are combined.

E.g. the galvanized Spiral Vertical output = the horizontal output x 0,7x0,9.

## How to recalculate heating output to a different temperature gradient

### Parameters

T1 / T2 / Ti [°C]    T1 [°C] - inlet temperature of the heating medium  
T2 [°C] - outlet temperature of the heating medium  
Ti [°C] - room temperature

### Heating output at a different temperature gradient

$$Q [W] = Q_{\Delta T50} [W] \cdot \left( \frac{\Delta T [K]}{50} \right)^{n[-]}, \text{ where } \Delta T [K] = \frac{T1 [^{\circ}C] + T2 [^{\circ}C]}{2} - Ti [^{\circ}C]$$

Example: **Required performance for RAT2 57x137 length 2000 mm for parameters 70/60/20 °C**

Input parameters: RAT2, model 57x137, L= 2000 mm,  $Q_{\Delta T50} = 1299$  W,  $n = 1,2797$  [-] (see page 21)

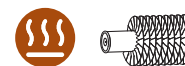
$$Q_{\Delta T45} [W] = 1299 [W] \cdot \left( \frac{45 [K]}{50 [K]} \right)^{1,2797 [-]} = 1135 \text{ W, where } \Delta T [K] = \frac{70+60}{2} - 20 [^{\circ}C] = 45 \text{ K}$$

Calculated heating output 70/60/20°C:

$$Q_{\Delta T45} = 1135 \text{ W}$$

The calculation is according to the EN422-2 standard. More accurate calculations may vary slightly.

# Spiral Horizontal heating output $\Delta T = 60 \text{ K}$



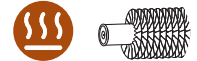
$\Delta T = 60 \text{ K}$  / Temperature gradient (90/70/20 °C) / Length 500–2 400 mm

Type	Model	n [-]	Length [mm] / Heating output [W]																			
			500	600	700	800	900	1000	1100	1200	1300	1400	1500	1600	1700	1800	1900	2000	2100	2200	2300	2400
RA1	Ø32x92	1,3062	173	208	245	280	318	355	392	429	467	505	542	580	618	656	694	732	770	810	848	886
	Ø57x137	1,2931	219	265	310	357	404	451	499	546	594	642	689	737	786	834	882	930	980	1028	1077	1127
	Ø76x156	1,2876	238	288	338	389	440	491	543	594	646	698	750	803	855	908	961	1013	1066	1119	1172	1227
	Ø89x169	1,2162	237	286	335	386	438	491	544	599	654	710	768	825	884	944	1002	1064	1123	1186	1247	1309
	Ø108x188	1,2170	243	296	350	404	461	518	576	634	694	754	815	876	939	1001	1065	1129	1193	1258	1323	1390
RA2	Ø32x92	1,2831	275	336	398	460	524	588	652	718	783	850	916	983	1051	1120	1188	1256	1324	1394	1463	1534
	Ø57x137	1,2795	360	439	520	601	684	768	852	938	1024	1110	1197	1284	1373	1462	1551	1640	1730	1821	1912	2003
	Ø76x156	1,2780	398	486	574	665	757	850	943	1038	1132	1228	1324	1421	1519	1617	1716	1814	1914	2014	2115	2215
	Ø89x169	1,2537	430	524	621	719	817	917	1018	1120	1223	1326	1430	1535	1640	1746	1853	1959	2067	2176	2284	2393
	Ø108x188	1,2581	463	566	670	775	882	990	1099	1209	1319	1431	1543	1657	1770	1884	1999	2114	2230	2347	2464	2582
RA3	Ø32x92	1,2788	378	462	547	633	720	808	896	986	1077	1168	1259	1351	1444	1538	1631	1725	1819	1915	2010	2106
	Ø57x137	1,2736	502	613	725	839	955	1071	1189	1308	1428	1549	1670	1792	1916	2040	2163	2288	2414	2540	2667	2794
	Ø76x156	1,2711	559	682	807	934	1063	1193	1324	1456	1590	1724	1860	1996	2132	2269	2408	2547	2687	2828	2969	3110
	Ø89x169	1,2745	594	725	859	994	1130	1269	1408	1549	1692	1834	1978	2123	2268	2415	2562	2710	2859	3009	3159	3309
	Ø108x188	1,2811	649	793	938	1086	1235	1387	1540	1694	1849	2005	2162	2320	2479	2640	2802	2963	3125	3289	3453	3618
RAO2	Ø32x92	1,2786	269	326	383	439	497	556	614	672	730	789	848	908	967	1026	1086	1145	1206	1265	1326	1386
	Ø57x137	1,2511	350	425	499	573	648	724	800	876	952	1029	1105	1183	1260	1338	1416	1494	1572	1651	1729	1808
	Ø76x156	1,2296	419	508	597	686	776	866	956	1047	1139	1230	1323	1415	1508	1600	1693	1787	1879	1973	2067	2161
	Ø89x169	1,2264	425	506	589	675	763	852	944	1037	1132	1229	1327	1427	1527	1629	1732	1837	1942	2048	2155	2264
	Ø108x188	1,2298	440	541	643	748	853	961	1070	1180	1291	1404	1517	1632	1748	1866	1983	2102	2222	2344	2465	2588
RAO3	Ø32x92	1,2511	358	433	509	585	662	739	817	893	971	1050	1128	1207	1286	1366	1445	1524	1604	1683	1764	1844
	Ø57x137	1,2090	471	571	671	770	873	974	1076	1178	1280	1384	1487	1591	1695	1800	1904	2010	2114	2219	2325	2431
	Ø76x156	1,1716	550	665	780	898	1015	1133	1252	1371	1491	1611	1731	1852	1974	2095	2216	2339	2461	2584	2707	2829
	Ø89x169	1,2365	-	678	794	925	1057	1191	1328	1466	1606	1747	1889	2033	2179	2324	2472	2621	2770	2920	3072	3224
	Ø108x188	1,2426	-	786	937	1090	1247	1405	1567	1730	1894	2061	2229	2398	2569	2742	2915	3091	3266	3444	3622	3802

$\Delta T = 60 \text{ K}$  / Temperature gradient (90/70/20 °C) / Length 2 500–6 000 mm

Type	Model	Length [mm] / Heating output [W]																				
		2500	2600	2700	2800	2900	3000	3200	3400	3600	3800	4000	4200	4400	4600	4800	5000	5200	5400	5600	5800	6000
RA1	Ø32x92	925	963	1002	1040	1080	1119	1197	1275	1354	1433	1511	1590	1670	1749	1828	1908	1988	2068	2148	2228	2308
	Ø57x137	1176	1224	1273	1323	1372	1422	1522	1620	1720	1820	1922	2022	2122	2223	2324	2425	2527	2629	2730	2833	2934
	Ø76x156	1280	1333	1387	1440	1495	1548	1657	1764	1873	1982	2092	2200	2310	2420	2530	2640	2751	2862	2973	3083	3194
	Ø89x169	1372	1434	1498	1562	1626	1690	1820	1950	2081	2213	2345	2479	2613	2747	2882	3020	3156	3294	3434	3575	3717
	Ø108x188	1456	1523	1589	1657	1725	1793	1930	2069	2207	2347	2488	2629	2772	2915	3059	3203	3350	3497	3644	3794	3944
RA2	Ø32x92	1603	1674	1745	1816	1887	1957	2101	2245	2391	2536	2683	2830	2978	3126	3275	3426	3576	3726	3878	4030	4181
	Ø57x137	2095	2186	2278	2371	2464	2557	2744	2932	3121	3312	3504	3696	3889	4084	4278	4474	4670	4867	5065	5263	5461
	Ø76x156	2316	2419	2520	2622	2726	2828	3036	3244	3453	3663	3876	4088	4302	4517	4731	4949	5166	5383	5601	5821	6042
	Ø89x169	2502	2612	2722	2833	2943	3055	3279	3504	3730	3958	4186	4416	4646	4879	5111	5345	5579	5815	6052	6288	6525
	Ø108x188	2699	2819	2937	3056	3176	3297	3537	3781	4025	4270	4517	4765	5014	5264	5514	5767	6020	6274	6529	6785	7041
RA3	Ø32x92	2203	2299	2396	2494	2591	2689	2886	3084	3284	3483	3685	3887	4091	4294	4500	4704	4911	5118	5327	5535	5745
	Ø57x137	2923	3050	3179	3309	3437	3567	3828	4092	4356	4622	4889	5157	5426	5696	5969	6241	6515	6790	7066	7342	7620
	Ø76x156	3253	3395	3538	3682	3827	3972	4262	4554	4849	5144	5442	5740	6041	6341	6643	6947	7252	7559	7865	8174	8483
	Ø89x169	3461	3613	3765	3918	4071	4225	4535	4846	5159	5474	5789	6107	6427	6747	7070	7393	7717	8043	8369	8697	9027
	Ø108x188	3783	3948	4115	4283	4450	4619	4956	5297	5640	5983	6329	6677	7025	7375	7728	8081	8435	8791	9149	9507	9866
RAO2	Ø32x92	1447	1506	1567	1629	1689	1750	1872	1995	2117	2240	2363	2487	2611	2736	2860	2985	3110	3235	3360	3486	3611
	Ø57x137	1886	1965	2044	2123	2202	2281	2441	2600	2761	2922	3083	3244	3406	3568	3730	3892	4055	4218	4382	4545	4708
	Ø76x156	2256	2350	2445	2539	2634	2729	2919	3111	3302	3495	3686	3879	4073	4267	4461	4655	4850	5045	5240	5436	5632
	Ø89x169	2371	2481	2591	2701	2813	2924	3148	3373	3600	3828	4058	4288	4520	4752	4986	5221	5459	5698	5939	6183	6430
	Ø108x188	2710	2834	2959	3085	3210	3336	3591	3848	4107	4367	4629	4893	5158	5425	5692	5963	6234	6507	6782	7059	7338
RAO3	Ø32x92	1925	2005	2085	2167	2247	2329	2491	2654	2818	2981	3146	3310	3475	3639	3805	3971	4138	4304	4471	4638	4805
	Ø57x137	2537	2643	2749	2856	2962	3069	3284	3498	3714	3929	4146	4363	4580	4798	5016	5235	5454	5673	5893	6113	6334
	Ø76x156	2953	3077	3201	3324	3448	3573	3822	4072	4322	4574	4826	5079	5331	5585	5839	6094	6348	6604	6859	7116	7373
	Ø89x169	3378	3531	3686	3841	3998	4155	4472	4791	5112	5436	5762	6091	6422	6755	7090	7427	7765	8106	8448	8791	9137
	Ø108x188	3982	4164	4347	4530	4715	4900	5273	5649	6029	6411	6796	7183	7573	7966	8361	8759	9157	9560	9963	10369	10775

# Spiral Horizontal heating output $\Delta T = 50 \text{ K}$



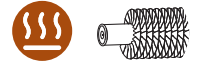
$\Delta T = 50 \text{ K}$  / Temperature gradient (75/65/20 °C) / Length 500–2 400 mm

Type	Model	n [-]	Length [mm] / Heating output [W]																			
			500	600	700	800	900	1000	1100	1200	1300	1400	1500	1600	1700	1800	1900	2000	2100	2200	2300	2400
RA1	Ø32x92	1,3062	136	164	193	221	251	280	309	338	368	398	427	457	487	517	547	577	607	638	668	698
	Ø57x137	1,2931	173	209	245	282	319	356	394	431	469	507	544	582	621	659	697	735	774	812	851	890
	Ø76x156	1,2876	188	228	267	308	348	388	429	470	511	552	593	635	676	718	760	801	843	885	927	970
	Ø89x169	1,2162	190	229	268	309	351	393	436	480	524	569	615	661	708	756	803	852	900	950	999	1049
	Ø108x188	1,2170	195	237	280	324	369	415	461	508	556	604	653	702	752	802	853	904	956	1008	1060	1113
RA2	Ø32x92	1,2831	218	266	315	364	415	465	516	568	620	673	725	778	832	886	940	994	1048	1103	1158	1214
	Ø57x137	1,2795	285	348	412	476	542	608	675	743	811	879	948	1017	1087	1158	1228	1299	1370	1442	1514	1586
	Ø76x156	1,2780	315	385	455	527	600	673	747	822	897	973	1049	1126	1203	1281	1359	1437	1516	1595	1675	1755
	Ø89x169	1,2537	342	417	494	572	650	730	810	891	973	1055	1138	1221	1305	1389	1474	1559	1645	1731	1817	1904
	Ø108x188	1,2581	368	450	533	616	701	787	874	961	1049	1138	1227	1317	1407	1498	1589	1681	1773	1866	1959	2053
RA3	Ø32x92	1,2788	299	366	433	501	570	640	710	781	853	925	997	1070	1144	1218	1292	1366	1441	1517	1592	1668
	Ø57x137	1,2736	398	486	575	665	757	849	943	1037	1132	1228	1324	1421	1519	1617	1715	1814	1914	2014	2114	2215
	Ø76x156	1,2711	443	541	640	741	843	946	1050	1155	1261	1367	1475	1583	1691	1800	1910	2020	2131	2243	2355	2467
	Ø89x169	1,2745	471	575	681	788	896	1006	1116	1228	1341	1454	1568	1683	1798	1914	2031	2148	2266	2385	2504	2623
	Ø108x188	1,2811	514	628	743	860	978	1098	1219	1341	1464	1587	1712	1837	1963	2090	2218	2346	2474	2604	2734	2864
RAO2	Ø32x92	1,2786	213	258	303	348	394	440	486	532	578	625	672	719	766	813	860	907	955	1002	1050	1098
	Ø57x137	1,2511	279	338	397	456	516	576	637	697	758	819	880	942	1003	1065	1127	1189	1251	1314	1376	1439
	Ø76x156	1,2296	335	406	477	548	620	692	764	837	910	983	1057	1131	1205	1279	1353	1428	1502	1577	1652	1727
	Ø89x169	1,2264	340	405	471	540	610	681	755	829	905	983	1061	1141	1221	1303	1385	1469	1553	1638	1723	1810
	Ø108x188	1,2298	352	432	514	598	682	768	855	943	1032	1122	1212	1304	1397	1491	1585	1680	1776	1873	1970	2068
RAO3	Ø32x92	1,2511	285	345	405	466	527	588	650	711	773	836	898	961	1024	1087	1150	1213	1277	1340	1404	1468
	Ø57x137	1,2090	378	458	538	618	700	781	863	945	1027	1110	1193	1276	1360	1444	1527	1612	1696	1780	1865	1950
	Ø76x156	1,1716	444	537	630	725	820	915	1011	1107	1204	1301	1398	1496	1594	1692	1790	1889	1988	2087	2186	2285
	Ø89x169	1,2365	-	541	634	738	844	951	1060	1170	1282	1394	1508	1623	1739	1855	1973	2092	2211	2331	2452	2573
	Ø108x188	1,2426	-	627	747	869	994	1120	1249	1379	1510	1643	1777	1912	2048	2186	2324	2464	2604	2746	2888	3031

$\Delta T = 50 \text{ K}$  / Temperature gradient (75/65/20 °C) / Length 2 500–6 000 mm

Type	Model	Length [mm] / Heating output [W]																				
		2500	2600	2700	2800	2900	3000	3200	3400	3600	3800	4000	4200	4400	4600	4800	5000	5200	5400	5600	5800	6000
RA1	Ø32x92	729	759	790	820	851	882	943	1005	1067	1129	1191	1253	1316	1378	1441	1504	1567	1630	1693	1756	1819
	Ø57x137	929	967	1006	1045	1084	1123	1202	1280	1359	1438	1518	1597	1676	1756	1836	1916	1996	2077	2157	2238	2318
	Ø76x156	1012	1054	1097	1139	1182	1224	1310	1395	1481	1567	1654	1740	1827	1914	2001	2088	2175	2263	2351	2438	2526
	Ø89x169	1099	1149	1200	1251	1303	1354	1458	1562	1667	1773	1879	1986	2093	2201	2309	2419	2528	2639	2751	2864	2978
	Ø108x188	1166	1220	1273	1327	1382	1436	1546	1657	1768	1880	1993	2106	2220	2335	2450	2566	2683	2801	2919	3039	3159
RA2	Ø32x92	1269	1325	1381	1437	1493	1549	1663	1777	1892	2007	2123	2240	2357	2474	2592	2711	2830	2949	3069	3189	3309
	Ø57x137	1659	1731	1804	1878	1951	2025	2173	2322	2472	2623	2775	2927	3080	3234	3388	3543	3698	3854	4011	4168	4325
	Ø76x156	1835	1916	1996	2077	2159	2240	2405	2570	2735	2902	3070	3238	3408	3578	3748	3920	4092	4264	4437	4611	4786
	Ø89x169	1991	2078	2166	2254	2342	2431	2609	2788	2968	3149	3331	3514	3697	3882	4067	4253	4439	4627	4815	5003	5192
	Ø108x188	2146	2241	2335	2430	2525	2621	2812	3006	3200	3395	3591	3788	3986	4185	4384	4585	4786	4988	5191	5394	5598
RA3	Ø32x92	1745	1821	1898	1975	2052	2130	2286	2443	2601	2759	2919	3079	3240	3401	3564	3726	3890	4054	4219	4384	4550
	Ø57x137	2317	2418	2520	2623	2725	2828	3035	3244	3453	3664	3876	4088	4302	4516	4732	4948	5165	5383	5602	5821	6041
	Ø76x156	2580	2693	2806	2920	3035	3150	3380	3612	3846	4080	4316	4553	4791	5029	5269	5510	5752	5995	6238	6483	6728
	Ø89x169	2743	2864	2984	3106	3227	3349	3595	3841	4089	4339	4589	4841	5094	5348	5604	5860	6117	6375	6634	6894	7155
	Ø108x188	2995	3126	3258	3391	3523	3657	3924	4194	4465	4737	5011	5286	5562	5839	6118	6398	6678	6960	7243	7527	7811
RAO2	Ø32x92	1146	1193	1241	1290	1338	1386	1483	1580	1677	1774	1872	1970	2068	2167	2265	2364	2463	2562	2661	2761	2860
	Ø57x137	1501	1564	1627	1690	1753	1816	1943	2070	2198	2326	2454	2582	2711	2840	2969	3098	3228	3358	3488	3618	3748
	Ø76x156	1803	1878	1954	2029	2105	2181	2333	2486	2639	2793	2946	3100	3255	3410	3565	3720	3876	4032	4188	4344	4501
	Ø89x169	1896	1984	2072	2160	2249	2338	2517	2697	2879	3061	3245	3429	3614	3800	3987	4175	4365	4556	4749	4944	5142
	Ø108x188	2166	2265	2365	2465	2565	2666	2870	3075	3282	3490	3699	3910	4122	4335	4549	4765	4982	5200	5420	5641	5864
RAO3	Ø32x92	1532	1596	1660	1725	1789	1854	1983	2113	2243	2373	2504	2635	2766	2897	3029	3161	3294	3426	3559	3692	3825
	Ø57x137	2035	2120	2205	2291	2376	2462	2634	2806	2979	3152	3326	3500	3674	3849	4024	4199	4375	4551	4727	4904	5081
	Ø76x156	2385	2485	2585	2685	2785	2886	3087	3289	3491	3694	3898	4102	4306	4511	4716	4922	5127	5334	5540	5747	5955
	Ø89x169	2696	2818	2942	3066	3191	3316	3569	3824	4080	4339	4599	4862	5126	5392	5659	5928	6198	6470	6743	7017	7293
	Ø108x188	3175	3320	3466	3612	3759	3907	4204	4504	4807	5111	5418	5727	6038	6351	6666	6983	7301	7622	7943	8267	8591

# Spiral Horizontal heating output $\Delta T = 42,5 \text{ K}$



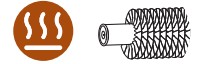
$\Delta T = 42,5 \text{ K}$  / Temperature gradient (70/55/20 °C) / Length 500–2 400 mm

Type	Model	n [-]	Length [mm] / Heating output [W]																			
			500	600	700	800	900	1000	1100	1200	1300	1400	1500	1600	1700	1800	1900	2000	2100	2200	2300	2400
RA1	Ø32x92	1,3062	110	133	156	179	203	226	250	273	298	322	345	370	394	418	442	467	491	516	540	564
	Ø57x137	1,2931	140	169	199	229	259	289	319	349	380	411	441	472	503	534	565	596	627	658	690	721
	Ø76x156	1,2876	153	185	217	250	282	315	348	381	415	448	481	515	548	582	617	650	684	718	752	787
	Ø89x169	1,2162	156	188	220	254	288	323	358	394	430	467	505	542	581	620	659	699	739	780	820	861
	Ø108x188	1,2170	160	194	230	266	303	341	378	417	456	496	536	576	617	658	700	742	784	827	870	913
RA2	Ø32x92	1,2831	177	216	256	295	337	377	419	461	503	546	589	632	675	719	763	807	851	895	940	985
	Ø57x137	1,2795	231	283	335	387	440	494	548	604	659	714	770	826	883	941	997	1055	1113	1171	1230	1288
	Ø76x156	1,2780	256	313	370	428	487	547	607	668	729	791	852	915	977	1041	1104	1167	1232	1296	1361	1426
	Ø89x169	1,2537	279	340	403	467	530	595	661	727	794	861	928	996	1064	1133	1202	1272	1342	1412	1482	1553
	Ø108x188	1,2581	300	367	434	502	571	641	712	783	855	928	1000	1073	1147	1221	1295	1370	1445	1521	1597	1673
RA3	Ø32x92	1,2788	243	297	352	407	463	520	577	634	693	751	810	869	929	989	1050	1110	1171	1232	1293	1355
	Ø57x137	1,2736	324	395	467	541	615	690	767	843	920	998	1076	1155	1235	1315	1394	1475	1556	1637	1719	1801
	Ø76x156	1,2711	360	440	521	603	686	769	854	939	1026	1112	1200	1288	1375	1464	1554	1643	1733	1824	1915	2007
	Ø89x169	1,2745	383	467	554	641	728	818	907	998	1090	1182	1275	1368	1462	1556	1651	1746	1842	1939	2036	2132
	Ø108x188	1,2811	417	510	603	698	794	892	990	1089	1189	1289	1390	1492	1594	1697	1801	1905	2009	2115	2220	2326
RAO2	Ø32x92	1,2786	173	210	246	283	320	357	395	432	470	508	546	584	622	660	699	737	776	814	853	892
	Ø57x137	1,2511	228	276	324	372	421	470	520	569	619	668	718	769	818	869	920	970	1021	1072	1123	1174
	Ø76x156	1,2296	274	332	391	449	508	567	626	685	745	805	866	926	987	1047	1108	1169	1230	1291	1353	1414
	Ø89x169	1,2264	279	332	386	442	500	558	619	679	741	805	869	935	1000	1068	1135	1204	1272	1342	1412	1483
	Ø108x188	1,2298	288	354	421	490	558	629	700	772	845	919	992	1068	1144	1221	1298	1376	1454	1534	1613	1693
RAO3	Ø32x92	1,2511	233	282	330	380	430	480	530	580	631	682	733	784	836	887	938	990	1042	1093	1146	1198
	Ø57x137	1,2090	311	376	442	508	575	642	709	776	844	912	980	1048	1117	1186	1255	1324	1393	1462	1532	1602
	Ø76x156	1,1716	367	444	521	599	678	756	836	915	995	1075	1156	1237	1318	1399	1480	1561	1643	1725	1807	1889
	Ø89x169	1,2365	-	443	519	604	690	778	867	957	1049	1140	1233	1328	1422	1517	1614	1711	1808	1907	2006	2105
	Ø108x188	1,2426	-	512	610	710	812	915	1021	1127	1234	1343	1452	1562	1674	1786	1899	2013	2128	2244	2360	2477

$\Delta T = 42,5 \text{ K}$  / Temperature gradient (70/55/20 °C) / Length 2 500–6 000 mm

Type	Model	Length [mm] / Heating output [W]																				
		2500	2600	2700	2800	2900	3000	3200	3400	3600	3800	4000	4200	4400	4600	4800	5000	5200	5400	5600	5800	6000
RA1	Ø32x92	590	614	639	663	688	713	763	813	863	913	963	1013	1064	1114	1165	1216	1267	1318	1369	1420	1471
	Ø57x137	753	784	815	847	879	910	974	1037	1101	1165	1230	1294	1358	1423	1488	1553	1618	1683	1748	1814	1879
	Ø76x156	821	855	890	924	959	993	1063	1132	1201	1271	1342	1411	1482	1553	1623	1694	1764	1836	1907	1978	2049
	Ø89x169	902	943	985	1027	1069	1111	1197	1282	1368	1455	1542	1630	1718	1806	1895	1985	2075	2166	2258	2350	2444
	Ø108x188	957	1001	1045	1089	1134	1178	1269	1360	1451	1543	1635	1728	1822	1916	2010	2106	2202	2298	2395	2494	2592
RA2	Ø32x92	1030	1076	1121	1167	1212	1257	1350	1443	1536	1629	1723	1818	1913	2008	2104	2201	2297	2394	2491	2589	2686
	Ø57x137	1348	1406	1465	1525	1585	1645	1765	1886	2008	2131	2254	2377	2502	2627	2752	2878	3004	3130	3258	3385	3513
	Ø76x156	1491	1557	1622	1687	1754	1820	1954	2088	2222	2358	2494	2631	2769	2907	3045	3185	3325	3464	3605	3746	3888
	Ø89x169	1624	1695	1767	1839	1910	1983	2128	2274	2421	2569	2717	2866	3016	3166	3317	3469	3621	3774	3927	4081	4235
	Ø108x188	1749	1827	1903	1981	2058	2136	2292	2450	2608	2767	2927	3088	3249	3411	3573	3737	3901	4066	4231	4397	4563
RA3	Ø32x92	1418	1479	1542	1604	1667	1730	1857	1985	2113	2241	2371	2501	2632	2763	2895	3027	3160	3293	3427	3561	3696
	Ø57x137	1884	1966	2049	2133	2216	2299	2468	2637	2807	2979	3151	3324	3498	3672	3847	4023	4199	4377	4555	4733	4912
	Ø76x156	2098	2190	2282	2375	2469	2562	2749	2938	3128	3319	3510	3703	3897	4090	4286	4482	4678	4876	5074	5273	5472
	Ø89x169	2230	2328	2426	2525	2623	2722	2922	3122	3324	3527	3730	3935	4141	4347	4556	4764	4973	5182	5393	5604	5816
	Ø108x188	2432	2538	2646	2754	2861	2970	3186	3406	3626	3847	4069	4292	4517	4742	4968	5195	5423	5652	5882	6112	6343
RAO2	Ø32x92	931	969	1008	1048	1087	1126	1205	1284	1362	1441	1521	1600	1680	1760	1840	1920	2001	2081	2162	2243	2323
	Ø57x137	1225	1276	1328	1379	1430	1482	1586	1689	1794	1898	2002	2107	2212	2317	2423	2528	2634	2740	2846	2952	3058
	Ø76x156	1476	1538	1600	1661	1724	1786	1910	2036	2161	2287	2412	2538	2665	2792	2919	3046	3174	3302	3429	3557	3686
	Ø89x169	1553	1625	1698	1770	1843	1916	2062	2210	2359	2508	2659	2809	2961	3113	3267	3421	3576	3733	3891	4051	4213
	Ø108x188	1774	1855	1937	2018	2100	2183	2350	2518	2687	2858	3029	3202	3375	3550	3725	3902	4079	4258	4438	4619	4802
RAO3	Ø32x92	1250	1302	1355	1408	1460	1513	1618	1724	1830	1936	2043	2150	2257	2364	2472	2579	2688	2796	2904	3013	3121
	Ø57x137	1672	1742	1812	1882	1952	2023	2164	2305	2448	2590	2733	2876	3019	3162	3306	3450	3595	3739	3884	4029	4175
	Ø76x156	1971	2054	2137	2219	2302	2386	2552	2719	2886	3054	3222	3391	3559	3729	3898	4069	4238	4409	4579	4751	4923
	Ø89x169	2205	2305	2406	2508	2610	2712	2919	3128	3337	3549	3762	3977	4193	4410	4629	4849	5070	5292	5515	5740	5965
	Ø108x188	2594	2713	2832	2952	3072	3193	3435	3680	3928	4176	4427	4680	4934	5190	5447	5706	5966	6228	6491	6755	7020

# Spiral Horizontal heating output $\Delta T = 30 \text{ K}$



$\Delta T = 30 \text{ K}$  / Temperature gradient (55/45/20 °C) / Length 500–2 400 mm

Type	Model	n [-]	Length [mm] / Heating output [W]																			
			500	600	700	800	900	1000	1100	1200	1300	1400	1500	1600	1700	1800	1900	2000	2100	2200	2300	2400
RA1	Ø32x92	1,3062	70	84	99	113	129	144	159	173	189	204	219	234	250	265	281	296	311	327	343	358
	Ø57x137	1,2931	89	108	127	146	165	184	204	223	242	262	281	301	321	340	360	380	400	419	440	460
	Ø76x156	1,2876	97	118	138	160	180	201	222	243	265	286	307	329	350	372	394	415	437	458	480	502
	Ø89x169	1,2162	102	123	144	166	189	211	234	258	282	306	330	355	380	406	431	458	484	510	537	564
	Ø108x188	1,2170	105	127	150	174	198	223	248	273	299	324	351	377	404	431	458	485	513	541	569	598
RA2	Ø32x92	1,2831	113	138	164	189	215	241	268	295	322	349	376	404	432	460	488	516	544	573	601	630
	Ø57x137	1,2795	148	181	214	248	282	316	351	386	422	457	493	529	565	602	639	676	713	750	788	825
	Ø76x156	1,2780	164	200	237	274	312	350	389	428	467	507	546	586	626	667	707	748	789	830	872	914
	Ø89x169	1,2537	180	220	260	301	343	385	427	470	513	556	600	644	688	732	777	822	867	912	958	1004
	Ø108x188	1,2581	194	237	280	324	369	414	460	505	552	598	645	693	740	788	836	884	932	981	1030	1080
RA3	Ø32x92	1,2788	156	190	225	261	297	333	369	406	444	481	519	557	595	634	672	711	750	789	828	868
	Ø57x137	1,2736	208	254	300	347	395	443	492	541	591	641	691	741	793	844	895	946	999	1051	1103	1156
	Ø76x156	1,2711	231	283	334	387	440	494	549	603	659	714	771	827	883	940	998	1055	1113	1172	1230	1289
	Ø89x169	1,2745	246	300	355	411	467	525	582	640	699	758	818	878	938	998	1059	1120	1182	1244	1306	1368
	Ø108x188	1,2811	267	326	386	447	508	571	634	697	761	825	890	955	1020	1086	1153	1219	1286	1353	1421	1489
RAO2	Ø32x92	1,2786	111	134	158	181	205	229	253	277	301	325	350	374	399	423	448	472	497	521	546	571
	Ø57x137	1,2511	147	178	210	241	272	304	336	368	400	432	464	497	529	562	595	628	660	693	726	759
	Ø76x156	1,2296	179	217	255	292	331	369	408	447	486	525	564	604	643	682	722	762	801	841	882	922
	Ø89x169	1,2264	182	216	252	289	326	364	404	443	484	525	567	610	653	696	740	785	830	875	921	967
	Ø108x188	1,2298	188	230	274	319	364	410	456	503	551	599	647	696	745	796	846	896	948	999	1051	1103
RAO3	Ø32x92	1,2511	150	182	214	246	278	310	343	375	408	441	474	507	540	574	607	640	674	707	741	775
	Ø57x137	1,2090	204	247	290	333	377	421	465	510	554	599	643	688	733	779	823	869	915	960	1006	1052
	Ø76x156	1,1716	244	295	346	398	451	503	556	608	662	715	768	822	876	930	984	1038	1093	1147	1202	1256
	Ø89x169	1,2365	-	288	337	392	449	506	564	622	682	741	802	863	925	986	1049	1112	1176	1239	1304	1368
	Ø108x188	1,2426	-	332	396	461	527	594	662	731	800	871	942	1013	1086	1159	1232	1306	1380	1456	1531	1607

$\Delta T = 30 \text{ K}$  / Temperature gradient (55/45/20 °C) / Length 2 500–6 000 mm

Type	Model	Length [mm] / Heating output [W]																				
		2500	2600	2700	2800	2900	3000	3200	3400	3600	3800	4000	4200	4400	4600	4800	5000	5200	5400	5600	5800	6000
RA1	Ø32x92	374	389	405	421	437	453	484	516	548	579	611	643	675	707	739	772	804	836	869	901	933
	Ø57x137	480	500	520	540	560	580	621	661	702	743	784	825	866	907	948	990	1031	1073	1114	1156	1197
	Ø76x156	524	546	568	590	612	634	679	723	767	812	857	901	946	991	1037	1082	1127	1172	1218	1263	1309
	Ø89x169	590	617	645	672	700	727	783	839	896	953	1010	1067	1124	1183	1241	1300	1358	1418	1478	1539	1600
	Ø108x188	626	655	684	713	742	771	830	890	949	1010	1070	1131	1192	1254	1316	1378	1441	1504	1568	1632	1697
RA2	Ø32x92	659	688	717	746	775	804	863	923	982	1042	1102	1163	1224	1285	1346	1408	1469	1531	1593	1656	1718
	Ø57x137	863	900	938	977	1015	1053	1130	1208	1286	1364	1443	1523	1602	1682	1762	1843	1924	2005	2086	2168	2250
	Ø76x156	955	997	1039	1081	1124	1166	1252	1338	1424	1511	1598	1686	1774	1863	1951	2041	2130	2220	2310	2400	2491
	Ø89x169	1049	1095	1142	1188	1234	1281	1375	1469	1564	1660	1756	1852	1949	2046	2144	2242	2340	2439	2538	2637	2737
	Ø108x188	1129	1179	1228	1278	1328	1378	1479	1581	1683	1785	1888	1992	2096	2201	2305	2411	2517	2623	2730	2837	2944
RA3	Ø32x92	908	948	988	1028	1068	1108	1190	1271	1353	1436	1519	1602	1686	1770	1855	1939	2024	2110	2195	2281	2368
	Ø57x137	1209	1262	1315	1369	1422	1475	1583	1693	1802	1912	2022	2133	2245	2356	2469	2582	2695	2809	2923	3037	3152
	Ø76x156	1348	1407	1466	1525	1586	1646	1766	1887	2009	2131	2255	2379	2503	2627	2753	2878	3005	3132	3259	3387	3515
	Ø89x169	1430	1494	1556	1620	1683	1747	1875	2003	2132	2263	2393	2525	2657	2789	2922	3056	3190	3325	3460	3595	3731
	Ø108x188	1557	1625	1693	1762	1831	1901	2039	2180	2321	2462	2604	2747	2891	3035	3180	3325	3471	3617	3765	3912	4060
RAO2	Ø32x92	596	621	646	671	696	721	772	822	873	923	974	1025	1076	1128	1179	1230	1282	1333	1385	1437	1488
	Ø57x137	792	825	859	892	925	958	1025	1092	1160	1228	1295	1363	1431	1499	1567	1635	1704	1772	1841	1909	1978
	Ø76x156	962	1002	1043	1083	1123	1164	1245	1327	1408	1490	1572	1654	1737	1820	1902	1985	2068	2151	2235	2318	2402
	Ø89x169	1013	1060	1107	1154	1202	1250	1345	1441	1539	1636	1734	1833	1932	2031	2131	2231	2333	2435	2538	2642	2748
	Ø108x188	1156	1208	1262	1315	1369	1422	1531	1641	1751	1862	1974	2086	2199	2313	2427	2542	2658	2774	2892	3010	3129
RAO3	Ø32x92	809	842	876	910	944	978	1047	1115	1184	1252	1322	1391	1460	1529	1599	1668	1738	1808	1878	1949	2019
	Ø57x137	1097	1143	1189	1235	1281	1328	1420	1513	1606	1700	1794	1887	1981	2076	2170	2264	2359	2454	2549	2644	2740
	Ø76x156	1311	1366	1421	1476	1531	1586	1697	1808	1919	2030	2143	2255	2367	2479	2592	2705	2818	2932	3045	3159	3273
	Ø89x169	1434	1498	1564	1630	1697	1763	1898	2033	2169	2307	2445	2585	2726	2867	3009	3152	3296	3440	3585	3731	3878
	Ø108x188	1683	1760	1837	1915	1993	2071	2228	2387	2548	2709	2872	3036	3201	3366	3533	3701	3870	4040	4210	4382	4554

# Reference weight: Spiral Horizontal / Vertical models



## Length 500–2 400 mm

Type	Model	Length [mm] / Weight [kg]																			
		500	600	700	800	900	1000	1100	1200	1300	1400	1500	1600	1700	1800	1900	2000	2100	2200	2300	2400
RA1	Ø32x92	3,0	3,5	4,5	5,0	5,5	6,5	7,0	8,0	8,5	9,0	10,0	10,5	11,5	12,0	12,5	13,5	14,0	14,5	15,5	16,0
	Ø57x137	4,0	5,0	6,0	7,0	7,5	8,5	9,5	10,5	11,5	12,5	13,5	14,5	15,0	16,0	17,0	18,0	19,0	20,0	21,0	22,0
	Ø76x156	4,5	6,0	7,0	8,0	9,0	10,0	11,0	12,0	13,0	14,5	15,5	16,5	17,5	18,5	19,5	20,5	22,0	23,0	24,0	25,0
	Ø89x169	6,0	7,5	9,0	10,0	11,5	13,0	14,0	15,5	17,0	18,0	19,5	21,0	22,0	23,5	25,0	26,0	27,5	29,0	30,5	31,5
	Ø108x188	7,0	9,0	10,5	12,0	13,5	15,0	16,5	18,0	20,0	21,5	23,0	24,5	26,0	27,5	29,0	30,5	32,5	34,0	35,5	37,0
RA2	Ø32x92	5,5	7,0	8,5	10,0	11,5	12,5	14,0	15,5	17,0	18,0	19,5	21,0	22,5	23,5	25,0	26,5	28,0	29,5	30,5	32,0
	Ø57x137	7,5	9,0	11,0	13,0	15,0	16,5	18,5	20,5	22,5	24,0	26,0	28,0	30,0	31,5	33,5	35,5	37,5	39,0	41,0	43,0
	Ø76x156	8,5	10,5	13,0	15,0	17,0	19,0	21,5	23,5	25,5	28,0	30,0	32,0	34,0	36,5	38,5	40,5	42,5	45,0	47,0	49,0
	Ø89x169	11,0	14,0	16,5	19,0	22,0	24,5	27,5	30,5	32,5	35,5	38,0	40,5	43,5	46,0	49,0	51,5	54,0	57,0	59,5	62,0
	Ø108x188	12,5	16,0	19,0	22,0	25,0	28,5	31,5	34,5	38,0	41,0	44,0	47,0	50,5	53,5	56,5	59,5	63,0	66,0	69,0	72,5
RA3	Ø32x92	8,5	11,0	13,0	15,0	17,0	19,0	21,0	23,0	25,5	27,5	29,5	31,5	33,5	35,5	38,0	40,0	42,0	44,0	46,0	48,0
	Ø57x137	11,5	14,0	17,0	20,0	22,5	25,5	28,0	31,0	34,0	36,5	39,5	42,0	45,0	48,0	50,5	53,5	56,5	59,0	62,0	64,5
	Ø76x156	13,5	16,5	19,5	23,0	26,0	29,5	32,5	36,0	39,0	42,0	45,5	48,5	52,0	55,0	58,0	61,5	64,5	68,0	71,0	74,0
	Ø89x169	17,5	21,5	25,5	29,5	33,5	37,5	41,5	46,0	50,0	54,0	58,0	62,0	66,0	70,0	74,0	78,0	82,0	86,0	90,0	94,0
	Ø108x188	20,0	25,0	29,5	34,0	39,0	43,5	48,5	53,0	57,5	62,5	67,0	72,0	76,5	81,0	86,0	90,5	95,5	100,0	104,5	109,5
RAO2	Ø32x92	5,5	6,5	8,0	9,5	11,0	12,5	13,5	15,0	16,5	18,0	19,0	20,5	22,0	23,5	24,5	26,0	27,5	29,0	30,5	31,5
	Ø57x137	7,0	9,0	10,5	12,5	14,5	16,5	18,0	20,0	22,0	24,0	25,5	27,5	29,5	31,5	33,0	35,0	37,0	39,0	40,5	42,5
	Ø76x156	8,0	10,0	12,5	14,5	16,5	18,5	21,0	23,0	25,0	27,0	29,5	31,5	33,5	36,0	38,0	40,0	42,0	44,5	46,5	48,5
	Ø89x169	10,5	13,0	16,0	18,5	21,0	24,0	26,5	29,0	32,0	34,5	37,5	40,0	42,5	45,5	48,0	50,5	53,5	56,0	59,0	61,5
	Ø108x188	12,0	15,5	18,5	21,5	24,5	28,0	31,0	34,0	37,5	40,5	43,5	46,5	50,0	53,0	56,0	59,0	62,5	65,5	68,5	72,0
RAO3	Ø32x92	7,0	9,0	11,0	13,5	15,5	17,5	19,5	21,5	23,5	25,5	28,0	30,0	32,0	34,0	36,0	38,0	40,5	42,5	44,5	46,5
	Ø57x137	9,0	12,0	15,0	17,5	20,5	23,0	26,0	29,0	31,5	34,5	37,0	40,0	43,0	45,5	48,5	51,5	54,0	57,0	59,5	62,5
	Ø76x156	10,0	13,0	16,5	19,5	22,5	26,0	29,0	32,5	35,5	38,5	42,0	45,0	48,5	51,5	54,5	58,0	61,0	64,5	67,5	70,5
	Ø89x169	13,0	17,0	21,0	25,0	29,0	33,0	37,0	41,0	45,0	49,0	53,0	57,5	61,5	65,5	69,5	73,5	77,5	81,5	85,5	89,5
	Ø108x188	14,5	19,5	24,0	28,5	33,5	38,0	43,0	47,5	52,0	57,0	61,5	66,5	71,0	76,0	80,5	85,0	90,0	94,5	99,5	104,0

## Length 2 500–6 000 mm

Type	Model	Length [mm] / Weight [kg]																				
		2500	2600	2700	2800	2900	3000	3200	3400	3600	3800	4000	4200	4400	4600	4800	5000	5200	5400	5600	5800	6000
RA1	Ø32x92	17,0	17,5	18,0	19,0	19,5	20,5	21,5	23,0	24,5	26,0	27,0	28,5	30,0	31,5	32,5	34,0	35,5	37,0	38,5	39,5	41,0
	Ø57x137	22,5	23,5	24,5	25,5	26,5	27,5	29,5	31,0	33,0	35,0	36,5	38,5	40,5	42,5	44,0	46,0	48,0	50,0	51,5	53,5	55,5
	Ø76x156	26,0	27,0	28,0	29,5	30,5	31,5	33,5	35,5	38,0	40,0	42,0	44,0	46,5	48,5	50,5	53,0	55,0	57,0	59,0	61,5	63,5
	Ø89x169	33,0	34,5	35,5	37,0	38,5	39,5	42,5	45,0	47,5	50,5	53,0	56,0	58,5	61,0	64,0	66,5	69,0	72,0	74,5	77,5	80,0
	Ø108x188	38,5	40,0	41,5	43,5	45,0	46,5	49,5	52,5	56,0	59,0	62,0	65,0	68,5	71,5	74,5	78,0	81,0	84,0	87,0	90,5	93,5
RA2	Ø32x92	33,5	35,0	36,0	37,5	39,0	40,5	43,0	46,0	48,5	51,5	54,5	57,0	60,0	62,5	65,5	68,0	71,0	73,5	76,5	79,5	82,0
	Ø57x137	45,0	46,5	48,5	50,5	52,5	54,0	58,0	61,5	65,5	69,0	73,0	76,5	80,5	84,5	88,0	92,0	95,5	99,5	103,0	107,0	110,5
	Ø76x156	51,5	53,5	55,5	57,5	60,0	62,0	66,5	70,5	75,0	79,0	83,5	87,5	92,0	96,5	100,5	105,0	109,0	113,5	117,5	122,0	126,5
	Ø89x169	65,0	67,5	70,5	73,0	75,5	78,5	84,0	89,0	94,5	100,5	105,5	110,5	116,0	121,5	127,0	132,0	137,5	143,0	148,5	153,5	159,0
	Ø108x188	75,5	78,5	81,5	85,0	88,0	91,0	97,5	103,5	110,0	116,5	122,5	129,0	135,0	141,5	147,5	154,0	160,5	166,5	173,0	179,0	185,5
RA3	Ø32x92	50,5	52,5	54,5	56,5	58,5	61,0	65,0	69,0	73,5	77,5	81,5	85,5	90,0	94,0	98,5	102,5	106,5	111,0	115,0	119,0	123,5
	Ø57x137	67,5	70,5	73,0	76,0	79,0	81,5	87,5	93,0	98,5	104,0	110,0	115,5	121,0	127,0	132,5	138,0	144,0	149,5	155,0	160,5	166,5
	Ø76x156	77,5	80,5	84,0	87,0	90,0	93,5	100,0	106,5	113,0	119,5	125,5	132,0	138,5	145,0	151,5	158,0	164,5	171,0	177,0	183,5	190,0
	Ø89x169	98,0	102,0	106,0	110,0	114,0	118,5	126,5	134,5	142,5	150,5	159,0	167,0	175,0	183,0	191,0	199,5	207,5	215,5	223,5	231,5	239,5
	Ø108x188	114,0	119,0	123,5	128,0	133,0	137,5	147,5	156,5	166,0	175,5	185,0	194,5	203,5	213,5	222,5	232,0	241,5	251,0	260,5	269,5	279,0
RAO2	Ø32x92	33,0	34,5	36,0	37,0	38,5	40,0	43,0	45,5	48,5	51,0	54,0	56,5	59,5	62,5	65,0	68,0	70,5	73,5	76,0	79,0	81,5
	Ø57x137	44,5	46,0	48,0	50,0	52,0	53,5	57,5	61,5	65,0	69,0	72,5	76,5	80,0	84,0	87,5	91,5	95,0	99,0	102,5	106,5	110,0
	Ø76x156	50,5	53,0	55,0	57,0	59,5	61,5	66,0	70,0	74,5	78,5	83,0	87,0	91,5	96,0	100,0	104,5	108,5	113,0	117,5	121,5	126,0
	Ø89x169	64,0	67,0	69,5	72,0	75,0	77,5	83,0	88,5	94,0	99,0	104,5	110,0	115,5	121,0	126,5	131,5	137,0	142,5	147,5	153,0	158,5
	Ø108x188	75,0	78,0	81,0	84,5	87,5	90,5	97,0	103,5	109,5	116,0	122,0	128,5	134,5	141,0	147,5	153,5	160,0	166,0	172,5	179,0	185,0
RAO3	Ø32x92	48,5	50,5	52,5	55,0	57,0	59,0	63,5	67,5	71,5	75,5	80,0	84,0	88,0	92,5	96,5	101,0	105,0	109,0	113,5	117,5	121,5
	Ø57x137	65,5	68,0	71,0	74,0	76,5	79,5	85,0	91,0	96,5	102,0	107,5	113,5	119,0	124,5	130,5	136,0	141,5	147,0	153,0	158,5	164,0
	Ø76x156	74,0	77,0	80,5	83,5	87,0	90,0	96,5	103,0	109,5	116,0	122,5	128,5	135,0	142,0	148,0	154,5	161,0	167,5	174,0	180,5	186,5
	Ø89x169	93,5	97,5	101,5	105,5	109,5	113,5	122,0	130,0	138,0	146,0	154,5	162,5	170,5	179,0	187,0	195,0	203,0	211,0	219,0	227,0	235,0
	Ø108x188	108,5	113,5	118,0	123,0	127,5	132,0	142,0	151,5	161,0	170,0	179,5	189,0	198,5	208,5	217,5	227,0	236,5	246,0	255,5	264,5	274,0

Weight may vary depending on the design of the Spiral (e.g. self-standing design)



# Reference weight: Spiral without fins Horizontal/Vertical models



Length 500–2 400 mm

Type	Model	Length [mm] / Weight [kg]																			
		500	600	700	800	900	1000	1100	1200	1300	1400	1500	1600	1700	1800	1900	2000	2100	2200	2300	2400
RA1	Ø32x92	1,0	1,0	1,0	1,0	1,5	1,5	1,5	2,0	2,0	2,0	2,5	2,5	2,5	2,5	3,0	3,0	3,0	3,5	3,5	3,5
	Ø57x137	2,0	2,0	2,5	3,0	3,0	3,5	4,0	4,0	4,5	5,0	5,0	5,5	6,0	6,0	6,5	7,0	7,0	7,5	8,0	8,0
	Ø76x156	2,5	3,0	3,5	4,0	4,5	4,5	5,0	5,5	6,0	6,5	7,0	7,5	8,0	8,5	9,0	9,5	9,5	10,0	10,5	11,0
	Ø89x169	3,5	4,5	5,0	5,5	6,5	7,0	7,5	8,5	9,0	10,0	10,5	11,0	12,0	12,5	13,0	14,0	14,5	15,0	16,0	16,5
	Ø108x188	4,5	5,5	6,0	7,0	8,0	8,5	9,5	10,5	11,0	12,0	13,0	13,5	14,5	15,5	16,0	17,0	18,0	18,5	19,5	20,0
RA2	Ø32x92	1,5	2,0	2,0	2,5	3,0	3,0	3,5	3,5	4,0	4,5	4,5	5,0	5,0	5,5	6,0	6,5	6,5	7,0	7,0	7,0
	Ø57x137	4,0	4,5	5,5	6,0	6,5	7,5	8,0	8,5	9,5	10,0	10,5	11,5	12,0	12,5	13,5	14,0	14,5	15,5	16,0	16,5
	Ø76x156	5,0	6,0	6,5	7,5	8,5	9,5	10,5	11,0	12,0	13,0	14,0	15,0	15,5	16,5	17,5	18,5	19,5	20,5	21,0	22,0
	Ø89x169	7,5	9,0	10,5	11,5	13,0	14,5	15,5	17,0	18,5	19,5	21,0	22,5	24,0	25,0	26,5	28,0	29,0	30,5	32,0	33,0
	Ø108x188	9,0	11,0	12,5	14,0	16,0	17,5	19,0	21,0	22,5	24,0	25,5	27,5	29,0	30,5	32,5	34,0	35,5	37,5	39,0	40,5
RA3	Ø32x92	2,5	3,0	3,5	4,0	4,0	4,5	5,0	5,5	6,0	6,5	7,0	7,5	8,0	8,0	8,5	9,0	9,5	10,0	10,5	11,0
	Ø57x137	5,5	6,5	7,5	8,5	9,5	10,5	11,5	12,5	13,5	14,5	15,5	16,5	17,5	18,5	19,5	20,5	21,5	22,5	23,5	24,5
	Ø76x156	7,5	9,0	10,5	11,5	13,0	14,5	16,0	17,0	18,5	20,0	21,0	22,5	24,0	25,5	26,5	28,0	29,5	30,5	32,0	33,5
	Ø89x169	12,0	14,0	16,0	18,0	20,0	22,0	24,0	26,0	28,0	30,0	32,0	34,0	36,5	38,5	40,5	42,5	44,5	46,5	48,5	50,5
	Ø108x188	14,5	17,0	19,5	22,0	24,5	27,0	29,5	32,0	34,5	37,0	39,5	42,0	44,5	47,0	49,5	52,0	54,5	56,5	59,0	61,5
RAO2	Ø32x92	1,5	2,0	2,0	2,5	3,0	3,0	3,5	3,5	4,0	4,5	4,5	5,0	5,0	5,5	6,0	6,0	6,5	6,5	7,0	7,0
	Ø57x137	3,5	4,5	5,0	5,5	6,5	7,0	7,5	8,5	9,0	9,5	10,5	11,0	11,5	12,5	13,0	13,5	14,5	15,0	15,5	16,5
	Ø76x156	5,0	6,0	7,0	8,0	8,5	9,5	10,5	11,5	12,5	13,0	14,0	15,0	16,0	17,0	17,5	18,5	19,5	20,5	21,5	22,0
	Ø89x169	7,5	9,0	10,0	11,5	13,0	14,5	15,5	17,0	18,5	19,5	21,0	22,5	23,5	25,0	26,5	28,0	29,0	30,5	32,0	33,0
	Ø108x188	9,5	11,0	12,5	14,5	16,0	17,5	19,5	21,0	22,5	24,0	26,0	27,5	29,0	31,0	32,5	34,0	36,0	37,5	39,0	40,5
RAO3	Ø32x92	2,5	3,0	3,5	4,0	4,0	4,5	5,0	5,5	6,0	6,5	7,0	7,5	8,0	8,0	8,5	9,0	9,5	10,0	10,5	11,0
	Ø57x137	5,5	6,5	7,5	8,5	9,5	10,5	11,5	12,5	13,5	14,5	15,5	16,5	17,5	18,5	19,5	20,5	21,5	22,5	23,5	24,5
	Ø76x156	7,5	9,0	10,5	11,5	13,0	14,5	16,0	17,0	18,5	20,0	21,0	22,5	24,0	25,5	26,5	28,0	29,5	30,5	32,0	33,5
	Ø89x169	11,5	13,5	15,5	17,5	19,5	21,5	23,5	25,5	27,5	29,5	31,5	33,5	35,5	37,5	39,5	41,5	44,0	46,0	48,0	50,0
	Ø108x188	14,0	16,5	19,0	21,5	24,0	26,5	29,0	31,5	34,0	36,5	39,0	41,5	44,0	46,5	49,0	51,5	54,0	56,5	58,5	61,0

Length 2 500–6 000 mm

Type	Model	Length [mm] / Weight [kg]																				
		2500	2600	2700	2800	2900	3000	3200	3400	3600	3800	4000	4200	4400	4600	4800	5000	5200	5400	5600	5800	6000
RA1	Ø32x92	3,5	4,0	4,0	4,0	4,5	4,5	5,0	5,0	5,5	5,5	6,0	6,0	6,5	7,0	7,0	7,5	7,5	8,0	8,5	8,5	9,0
	Ø57x137	8,5	9,0	9,0	9,5	10,0	10,0	11,0	11,5	12,0	13,0	13,5	14,0	15,0	15,5	16,0	17,0	17,5	18,0	19,0	19,5	20,0
	Ø76x156	11,5	12,0	12,5	13,0	13,5	14,0	14,5	15,5	16,5	17,5	18,5	19,0	20,0	21,0	22,0	23,0	23,5	24,5	25,5	26,5	27,5
	Ø89x169	17,0	18,0	18,5	19,0	20,0	20,5	22,0	23,5	24,5	26,0	27,5	28,5	30,0	31,5	32,5	34,0	35,5	37,0	38,0	39,5	41,0
	Ø108x188	21,0	22,0	22,5	23,5	24,5	25,0	27,0	28,5	30,0	32,0	33,5	35,0	36,5	38,5	40,0	41,5	43,5	45,0	46,5	48,5	50,0
RA2	Ø32x92	7,5	8,0	8,0	8,5	8,5	9,0	9,5	10,0	11,0	11,5	12,0	12,5	13,0	14,0	14,5	15,0	15,5	16,0	17,0	17,5	18,0
	Ø57x137	17,5	18,0	18,5	19,5	20,0	20,5	22,0	23,5	25,0	26,0	27,5	29,0	30,0	31,5	33,0	34,5	35,5	37,0	38,5	39,5	41,0
	Ø76x156	23,0	24,0	25,0	25,5	26,5	27,5	29,5	31,0	33,0	35,0	36,5	38,5	40,5	42,0	44,0	46,0	47,5	49,5	51,0	53,0	55,0
	Ø89x169	34,5	36,0	37,5	38,5	40,0	41,5	44,0	47,0	49,5	52,5	55,0	57,5	60,5	63,0	66,0	68,5	71,5	74,0	76,5	79,5	82,0
	Ø108x188	42,5	44,0	45,5	47,0	49,0	50,5	54,0	57,0	60,5	64,0	67,0	70,5	73,5	77,0	80,5	83,5	87,0	90,5	93,5	97,0	100,0
RA3	Ø32x92	11,5	12,0	12,0	12,5	13,0	13,5	14,5	15,5	16,5	17,0	18,0	19,0	20,0	21,0	22,0	22,5	23,5	24,5	25,5	26,5	27,0
	Ø57x137	25,5	26,5	28,0	29,0	30,0	31,0	33,0	35,0	37,0	39,0	41,0	43,0	45,0	47,5	49,5	51,5	53,5	55,5	57,5	59,5	61,5
	Ø76x156	34,5	36,0	37,5	39,0	40,0	41,5	44,5	47,0	50,0	52,5	55,5	58,0	60,5	63,5	66,5	69,0	72,0	74,5	77,0	80,0	82,5
	Ø89x169	52,5	54,5	56,5	58,5	60,5	62,5	67,0	71,0	75,0	79,0	83,0	87,0	91,0	95,5	99,5	103,5	107,5	111,5	115,5	120,0	124,0
	Ø108x188	64,0	66,5	69,0	71,5	74,0	76,5	81,5	86,5	91,5	96,5	101,5	106,5	111,5	116,5	121,5	126,5	131,5	136,5	141,5	146,5	151,0
RAO2	Ø32x92	7,5	8,0	8,0	8,5	8,5	9,0	9,5	10,5	11,0	11,5	12,0	12,5	13,0	14,0	14,5	15,0	15,5	16,0	17,0	17,5	18,0
	Ø57x137	17,0	17,5	18,5	19,0	20,0	20,5	22,0	23,0	24,5	26,0	27,0	28,5	30,0	31,5	32,5	34,0	35,5	36,5	38,0	39,5	40,5
	Ø76x156	23,0	24,0	25,0	26,0	27,0	27,5	29,5	31,5	33,0	35,0	37,0	38,5	40,5	42,5	44,0	46,0	48,0	49,5	51,5	53,5	55,0
	Ø89x169	34,5	36,0	37,0	38,5	40,0	41,5	44,0	47,0	49,5	52,5	55,0	57,5	60,5	63,0	66,0	68,5	71,5	74,0	76,5	79,5	82,0
	Ø108x188	42,5	44,0	45,5	47,5	49,0	50,5	54,0	57,5	60,5	64,0	67,5	70,5	74,0	77,5	81,0	84,0	87,5	90,5	94,0	97,5	100,5
RAO3	Ø32x92	11,5	12,0	12,0	12,5	13,0	13,5	14,5	15,5	16,5	17,0	18,0	19,0	20,0	21,0	22,0	22,5	23,5	24,5	25,5	26,0	27,0
	Ø57x137	25,5	26,5	27,5	28,5	29,5	31,0	33,0	35,0	37,0	39,0	41,0	43,0	45,0	47,0	49,0	51,0	53,0	55,0	57,0	59,0	61,5
	Ø76x156	35,0	36,0	37,5	39,0	40,0	41,5	44,5	47,5	50,0	52,5	55,5	58,0	61,0	64,0	66,5	69,0	72,0	74,5	77,5	80,0	83,0
	Ø89x169	52,0	54,0	56,0	58,0	60,0	62,0	66,5	70,5	74,5	78,5	82,5	86,5	90,5	95,0	99,0	103,0	107,0	111,5	115,5	119,5	123,5
	Ø108x188	63,5	66,0	68,5	71,0	73,5	76,0	81,5	86,5	91,5	96,5	101,0	106,0	111,0	116,5	121,5	126,5	131,5	136,5	141,5	146,0	151,0

Weight may vary depending on the design of the Spiral (e.g. self-standing design)



# Reference weight: Spiral ELECTRO Horizontal and Vertical



Length 500–2 000 mm

Type	Model	Length [mm] / Weight [kg]						
		500	750	1000	1250	1500	1750	2000
RA1	Ø57x137	5,0	8,0	10,5	13,5	16,5	19,5	22,0
	Ø76x156	6,5	10,5	14,0	17,5	21,0	25,0	28,5
RA2	Ø57x137	9,5	15,5	21,0	27,0	32,5	38,0	44,0
	Ø76x156	13,0	20,5	27,5	35,0	42,0	49,5	56,5
RA02	Ø57x137	9,0	14,5	20,5	26,0	32,0	37,5	43,0
	Ø76x156	12,0	19,5	26,5	34,0	41,0	48,5	55,5

The weight of the radiator filled with heating liquid

# Reference heating medium volume: Spiral Horizontal/Vertical, Spiral without fins Horizontal/Vertical



Length 500–2 400 mm

Type	Model	Length [mm] / Heating medium volume [l]																			
		500	600	700	800	900	1000	1100	1200	1300	1400	1500	1600	1700	1800	1900	2000	2100	2200	2300	2400
RA1 HRA1	Ø32x92	0,4	0,4	0,5	0,6	0,6	0,7	0,7	0,8	0,9	0,9	1,0	1,0	1,1	1,2	1,2	1,3	1,3	1,4	1,5	1,5
	Ø57x137	1,1	1,3	1,5	1,7	1,9	2,1	2,3	2,5	2,7	2,9	3,1	3,3	3,5	3,7	3,9	4,1	4,3	4,5	4,7	4,9
	Ø76x156	2,0	2,4	2,7	3,1	3,5	3,9	4,3	4,7	5,1	5,4	5,8	6,2	6,6	7,0	7,4	7,7	8,1	8,5	8,9	9,3
	Ø89x169	2,7	3,2	3,8	4,3	4,8	5,4	5,9	6,4	7,0	7,5	8,0	8,6	9,1	9,6	10,2	10,7	11,3	11,8	12,3	12,9
	Ø108x188	4,0	4,8	5,6	6,4	7,2	8,0	8,8	9,6	10,4	11,2	12,0	12,8	13,6	14,4	15,2	16,0	16,8	17,6	18,4	19,2
RA2 HRA2	Ø32x92	0,7	0,9	1,0	1,1	1,2	1,4	1,5	1,6	1,7	1,9	2,0	2,1	2,2	2,3	2,5	2,6	2,7	2,8	3,0	3,1
	Ø57x137	2,4	2,8	3,3	3,7	4,1	4,5	4,9	5,3	5,7	6,1	6,5	6,9	7,3	7,7	8,2	8,6	9,0	9,4	9,8	10,2
	Ø76x156	4,6	5,4	6,1	6,9	7,7	8,4	9,2	10,0	10,7	11,5	12,3	13,0	13,8	14,6	15,4	16,1	16,9	17,7	18,4	19,2
	Ø89x169	6,3	7,4	8,5	9,5	10,6	11,7	12,8	13,8	14,9	16,0	17,0	18,1	19,2	20,3	21,3	22,4	23,5	24,5	25,6	26,7
	Ø108x188	9,1	10,7	12,3	13,9	15,5	17,1	18,7	20,3	21,9	23,5	25,1	26,7	28,3	29,9	31,5	33,1	34,7	36,3	37,9	39,5
RA3 HRA3	Ø32x92	1,1	1,3	1,5	1,7	1,9	2,1	2,3	2,5	2,7	2,9	3,1	3,3	3,5	3,7	3,9	4,1	4,3	4,5	4,7	4,9
	Ø57x137	3,7	4,4	5,0	5,6	6,2	6,8	7,4	8,0	8,7	9,3	9,9	10,5	11,1	11,7	12,3	12,9	13,6	14,2	14,8	15,4
	Ø76x156	7,2	8,4	9,5	10,7	11,8	13,0	14,1	15,3	16,4	17,6	18,8	19,9	21,1	22,2	23,4	24,5	25,7	26,8	28,0	29,1
	Ø89x169	10,0	11,6	13,2	14,8	16,4	18,0	19,6	21,2	22,8	24,4	26,0	27,7	29,3	30,9	32,5	34,1	35,7	37,3	38,9	40,5
	Ø108x188	14,2	16,6	19,0	21,4	23,8	26,3	28,7	31,1	33,5	35,9	38,4	40,8	43,2	45,6	48,0	50,5	52,9	55,3	57,7	60,1
RAO2 HRAO2	Ø32x92	0,6	0,8	0,9	1,0	1,1	1,3	1,4	1,5	1,6	1,8	1,9	2,0	2,1	2,2	2,4	2,5	2,6	2,7	2,9	3,0
	Ø57x137	2,1	2,5	2,9	3,3	3,7	4,1	4,5	4,9	5,4	5,8	6,2	6,6	7,0	7,4	7,8	8,2	8,6	9,0	9,5	9,9
	Ø76x156	4,0	4,8	5,5	6,3	7,1	7,8	8,6	9,4	10,1	10,9	11,7	12,5	13,2	14,0	14,8	15,5	16,3	17,1	17,8	18,6
	Ø89x169	5,6	6,7	7,7	8,8	9,9	10,9	12,0	13,1	14,2	15,2	16,3	17,4	18,4	19,5	20,6	21,7	22,7	23,8	24,9	26,0
	Ø108x188	8,6	10,2	11,8	13,4	15,0	16,6	18,2	19,8	21,4	23,0	24,6	26,2	27,8	29,4	31,0	32,6	34,2	35,8	37,4	39,0
RAO3 HRAO3	Ø32x92	1,0	1,2	1,4	1,5	1,7	1,9	2,1	2,3	2,5	2,7	2,8	3,0	3,2	3,4	3,6	3,8	4,0	4,1	4,3	4,5
	Ø57x137	3,4	4,0	4,6	5,2	5,8	6,4	7,0	7,7	8,3	8,9	9,5	10,1	10,7	11,3	12,0	12,6	13,2	13,8	14,4	15,0
	Ø76x156	6,6	7,8	8,9	10,1	11,2	12,4	13,5	14,7	15,8	17,0	18,1	19,3	20,5	21,6	22,8	23,9	25,1	26,2	27,4	28,5
	Ø89x169	8,5	10,1	11,7	13,3	14,9	16,5	18,1	19,8	21,4	23,0	24,6	26,2	27,8	29,4	31,0	32,6	34,2	35,8	37,4	39,0
	Ø108x188	13,2	15,6	18,0	20,4	22,9	25,3	27,7	30,1	32,5	34,9	37,3	39,7	42,1	44,5	47,0	49,4	51,8	54,2	56,6	59,0

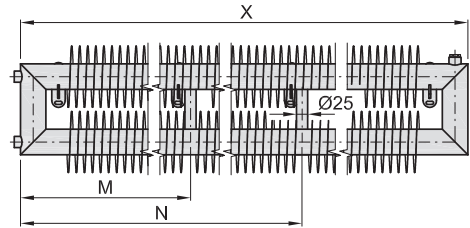
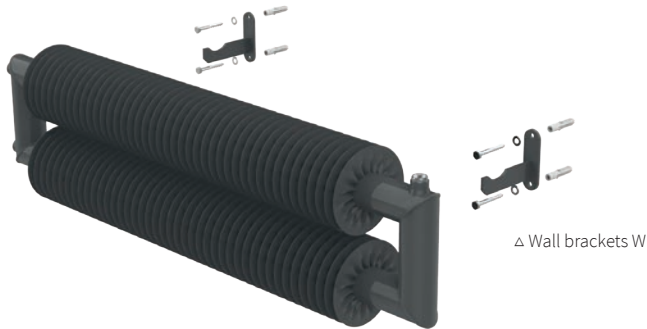
Length 500–2 400 mm

Type	Model	Length [mm] / Heating medium volume [l]																				
		2500	2600	2700	2800	2900	3000	3200	3400	3600	3800	4000	4200	4400	4600	4800	5000	5200	5400	5600	5800	6000
RA1 HRA1	Ø32x92	1,6	1,6	1,7	1,8	1,8	1,9	2,0	2,1	2,3	2,4	2,5	2,6	2,7	2,9	3,0	3,1	3,2	3,4	3,5	3,6	3,7
	Ø57x137	5,2	5,4	5,6	5,8	6,0	6,2	6,6	7,0	7,4	7,8	8,2	8,6	9,0	9,4	9,9	10,3	10,7	11,1	11,5	11,9	12,3
	Ø76x156	9,7	10,0	10,4	10,8	11,2	11,6	12,4	13,1	13,9	14,7	15,4	16,2	17,0	17,7	18,5	19,3	20,0	20,8	21,6	22,3	23,1
	Ø89x169	13,4	13,9	14,5	15,0	15,5	16,1	17,1	18,2	19,3	20,4	21,4	22,5	23,6	24,6	25,7	26,8	27,9	28,9	30,0	31,1	32,2
	Ø108x188	20,0	20,8	21,6	22,4	23,2	24,0	25,6	27,2	28,8	30,4	32,0	33,6	35,2	36,8	38,4	40,0	41,6	43,2	44,8	46,4	48,0
RA2 HRA2	Ø32x92	3,2	3,3	3,5	3,6	3,7	3,8	4,1	4,3	4,6	4,8	5,1	5,3	5,6	5,8	6,0	6,3	6,5	6,8	7,0	7,3	7,5
	Ø57x137	10,6	11,0	11,4	11,8	12,2	12,6	13,5	14,3	15,1	15,9	16,7	17,5	18,4	19,2	20,0	20,8	21,6	22,4	23,3	24,1	24,9
	Ø76x156	20,0	20,7	21,5	22,3	23,0	23,8	25,4	26,9	28,4	30,0	31,5	33,0	34,6	36,1	37,7	39,2	40,7	42,3	43,8	45,4	46,9
	Ø89x169	27,8	28,8	29,9	31,0	32,0	33,1	35,3	37,4	39,5	41,7	43,8	46,0	48,1	50,3	52,4	54,6	56,7	58,8	61,0	63,1	65,3
	Ø108x188	41,1	42,7	44,3	45,9	47,5	49,1	52,3	55,5	58,7	61,9	65,1	68,3	71,5	74,7	77,9	81,1	84,3	87,5	90,7	93,9	97,1
RA3 HRA3	Ø32x92	5,2	5,4	5,6	5,8	6,0	6,2	6,6	7,0	7,4	7,8	8,2	8,6	9,0	9,4	9,9	10,3	10,7	11,1	11,5	11,9	12,3
	Ø57x137	16,0	16,6	17,2	17,9	18,5	19,1	20,3	21,5	22,8	24,0	25,2	26,4	27,7	28,9	30,1	31,3	32,6	33,8	35,0	36,3	37,5
	Ø76x156	30,3	31,5	32,6	33,8	34,9	36,1	38,4	40,7	43,0	45,3	47,6	49,9	52,2	54,5	56,8	59,2	61,5	63,8	66,1	68,4	70,7
	Ø89x169	42,1	43,7	45,3	46,9	48,5	50,2	53,4	56,6	59,8	63,0	66,2	69,4	72,7	75,9	79,1	82,3	85,5	88,7	92,0	95,2	98,4
	Ø108x188	62,6	65,0	67,4	69,8	72,2	74,7	79,5	84,3	89,2	94,0	98,9	103,7	108,5	113,4	118,2	123,1	127,9	132,7	137,6	142,4	147,3
RAO2 HRAO2	Ø32x92	3,1	3,2	3,3	3,5	3,6	3,7	4,0	4,2	4,5	4,7	4,9	5,2	5,4	5,7	5,9	6,2	6,4	6,7	6,9	7,2	7,4
	Ø57x137	10,3	10,7	11,1	11,5	11,9	12,3	13,1	14,0	14,8	15,6	16,4	17,2	18,0	18,9	19,7	20,5	21,3	22,1	23,0	23,8	24,6
	Ø76x156	19,4	20,2	20,9	21,7	22,5	23,2	24,8	26,3	27,9	29,4	30,9	32,5	34,0	35,6	37,1	38,6	40,2	41,7	43,3	44,8	46,3
	Ø89x169	27,0	28,1	29,2	30,2	31,3	32,4	34,5	36,7	38,8	41,0	43,1	45,2	47,4	49,5	51,7	53,8	56,0	58,1	60,2	62,4	64,5
	Ø108x188	40,6	42,2	43,8	45,4	47,0	48,6	51,8	55,0	58,2	61,4	64,6	67,8	71,0	74,2	77,4	80,6	83,8	87,0	90,2	93,4	96,6
RAO3 HRAO3	Ø32x92	4,7	4,9	5,1	5,2	5,4	5,6	6,0	6,4	6,7	7,1	7,5	7,8	8,2	8,6	9,0	9,3	9,7	10,1	10,4	10,8	11,2
	Ø57x137	15,6	16,2	16,9	17,5	18,1	18,7	19,9	21,2	22,4	23,6	24,8	26,1	27,3	28,5	29,7	31,0	32,2	33,4	34,6	35,9	37,1
	Ø76x156	29,7	30,8	32,0	33,2	34,3	35,5	37,8	40,1	42,4	44,7	47,0	49,3	51,6	53,9	56,3	58,6	60,9	63,2	65,5	67,8	70,1
	Ø89x169	40,6	42,3	43,9	45,5	47,1	48,7	51,9	55,1	58,3	61,5	64,8	68,0	71,2	74,4	77,6	80,8	84,1	87,3	90,5	93,7	96,9
	Ø108x188	61,4	63,8	66,2	68,6	71,1	73,5	78,3	83,1	87,9	92,7	97,6	102,4	107,2	112,0	116,8	121,7	126,5	131,3	136,1	140,9	145,8

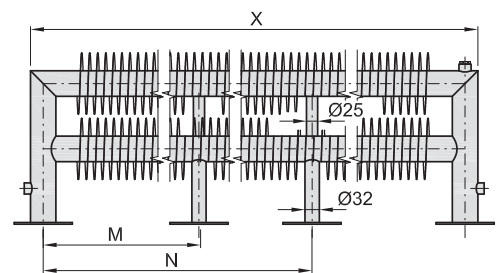
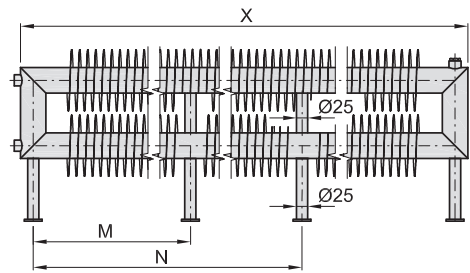
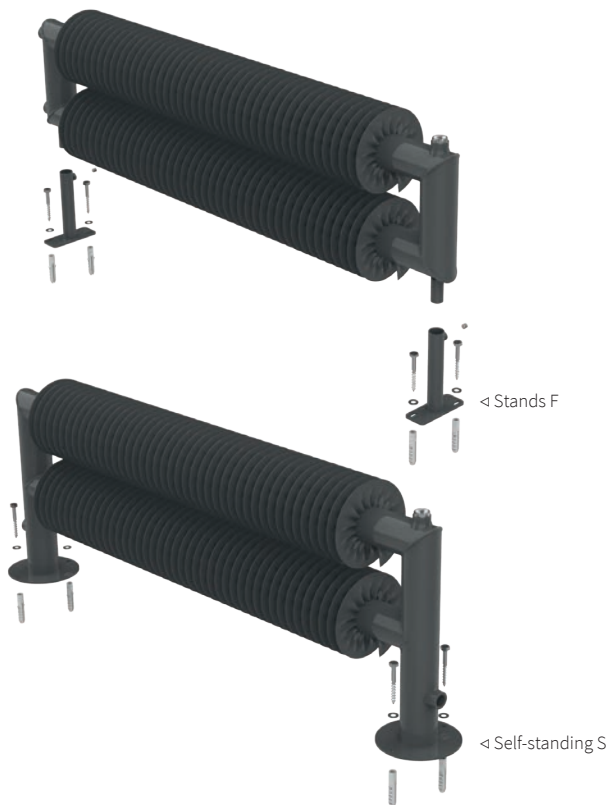
# Spiral mounting

## Spiral Horizontal

### Wall-mounted



### Floor-mounted



### Range of Spiral lengths and spacing of mounting elements

Model	M = 0, N = 0	M = ~ X/2, N = 0	M = ~ 1/3X, N = ~ 2/3X
Ø32	500-2900 mm	2901-4500 mm	4501-6000 mm
Ø57, Ø76, Ø89, Ø108	500-3000 mm	3001-4500 mm	4501-6000 mm

# Spiral mounting

## Spiral Vertical

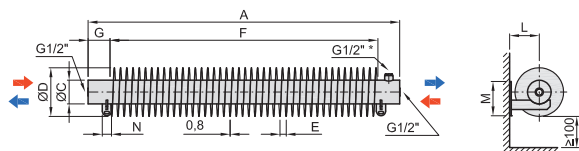
### Wall-mounted



# Spiral technical drawings

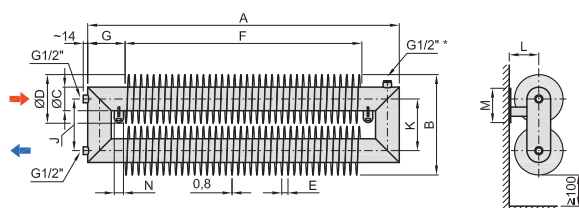
## Spiral Horizontal - WALL

### RA1-W



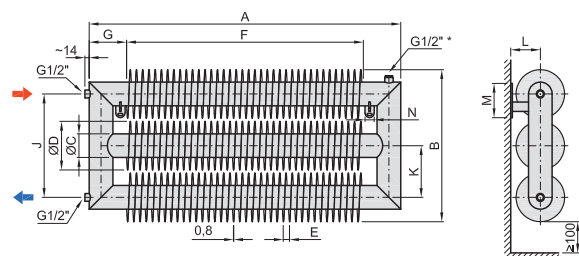
RA1-W	Ø32 x Ø92	Ø57 x Ø137	Ø76 x Ø156	Ø89 x Ø169	Ø108 x Ø188
A	500-6000				
B	-	-	-	-	-
C	32	57	76	89	108
D	92	137	156	169	188
E	10	18	20	20	20
F	A-100	A-140	A-140	A-140	A-140
G	50	70	70	70	70
J	-	-	-	-	-
L	60	85	95	102	111
M	90	100	110	115	125
N	25	30	30	30	35

### RAT2-W



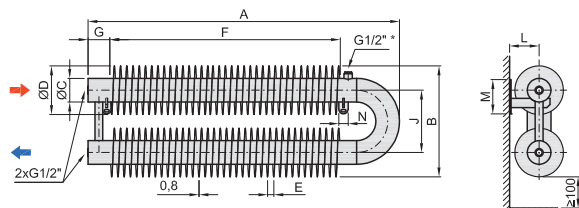
RAT2-W	Ø32 x Ø92	Ø57 x Ø137	Ø76 x Ø156	Ø89 x Ø169	Ø108 x Ø188
A	500-6000				
B	197	283	322	348	386
C	32	57	76	89	108
D	92	137	156	169	188
E	10	18	20	20	20
F	A-130	A-220	A-240	A-260	A-300
G	65	110	120	130	150
J	103	146	166	179	198
K	105	146	166	179	198
L	60	85	95	102	111
M	90	100	110	115	125
N	25	30	30	30	35

### RAT3-W



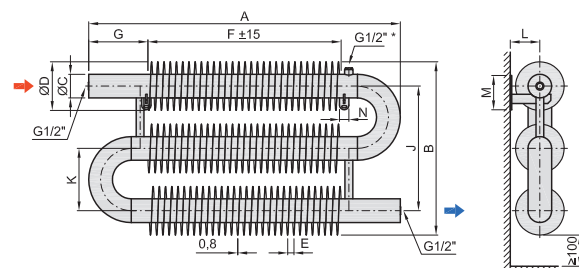
RAT3-W	Ø32 x Ø92	Ø57 x Ø137	Ø76 x Ø156	Ø89 x Ø169	Ø108 x Ø188
A	500-6000				
B	302	429	488	527	584
C	32	57	76	89	108
D	92	137	156	169	188
E	10	18	20	20	20
F	A-130	A-220	A-240	A-260	A-300
G	65	110	120	130	150
J	208	292	332	358	396
K	105	146	166	179	198
L	60	85	95	102	111
M	90	100	110	115	125
N	25	30	30	30	35

### RAO2-W



RAO2-W	Ø32 x Ø92	Ø57 x Ø137	Ø76 x Ø156	Ø89 x Ø169	Ø108 x Ø188
A	500-6000				
B	187	282 (312**)	356 (351**)	400	478
C	32	57	76	89	108
D	92	137	156	169	188
E	10	18	20	20	20
F	A-160	A-230	A-260	A-280	A-310
G	50	70	70	70	70
J	95	145 (175**)	200 (195**)	231	290
L	60	85	95	102	111
M	90	100	110	115	125
N	25	30	30	30	35

### RAO3-W



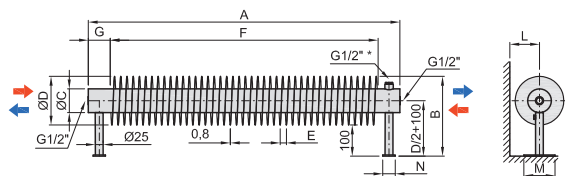
RAO3-W	Ø32 x Ø92	Ø57 x Ø137	Ø76 x Ø156	Ø89 x Ø169	Ø108 x Ø188
A	500-6000				
B	282	427 (487**)	556 (546**)	631	768
C	32	57	76	89	108
D	92	137	156	169	188
E	10	18	20	20	20
F	A-220	A-300	A-380	A-420	A-480
G	110	150	190	210	240
J	190	290 (350**)	400 (390**)	462	580
K	95	145 (175**)	200 (195**)	231	290
L	60	85	95	102	111
M	90	100	110	115	125
N	25	30	30	30	35

Dimension tolerance: **F** (fins length) +/- 15 mm / **J** (connection spacing) +/- 2,5 mm

\* airvent valve \*\* stainless steel construction, only ø32, 57 and 76 mm

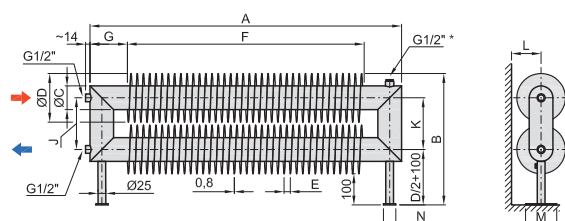
# Spiral Horizontal - FLOOR

## RA1-F



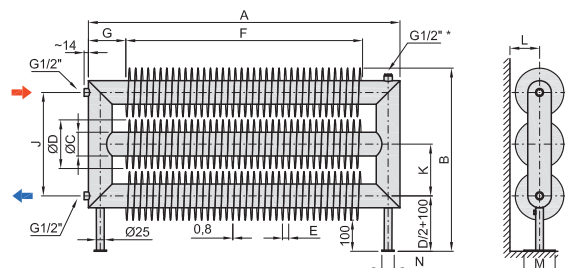
RA1-F	Ø32 x Ø92	Ø57 x Ø137	Ø76 x Ø156	Ø89 x Ø169	Ø108 x Ø188
A	500-6000				
B	192	237	256	269	288
C	32	57	76	89	108
D	92	137	156	169	188
E	10	18	20	20	20
F	A-100	A-140	A-140	A-140	A-140
G	50	70	70	70	70
J	-	-	-	-	-
L	≥60	≥85	≥95	≥102	≥111
M	100	100	100	160	160
N	40	40	40	60	60

## RAT2-F



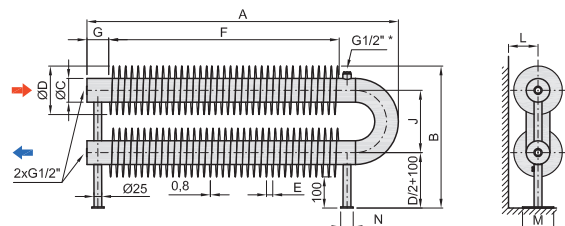
RAT2-F	Ø32 x Ø92	Ø57 x Ø137	Ø76 x Ø156	Ø89 x Ø169	Ø108 x Ø188
A	500-6000				
B	297	383	422	448	486
C	32	57	76	89	108
D	92	137	156	169	188
E	10	18	20	20	20
F	A-130	A-220	A-240	A-260	A-300
G	65	110	120	130	150
J	103	146	166	179	198
K	105	146	166	179	198
L	≥60	≥85	≥95	≥102	≥111
M	100	100	100	160	160
N	40	40	40	60	60

## RAT3-F



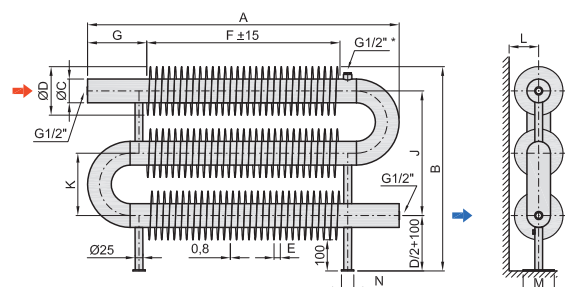
RAT3-F	Ø32 x Ø92	Ø57 x Ø137	Ø76 x Ø156	Ø89 x Ø169	Ø108 x Ø188
A	500-6000				
B	402	529	588	627	684
C	32	57	76	89	108
D	92	137	156	169	188
E	10	18	20	20	20
F	A-130	A-220	A-240	A-260	A-300
G	65	110	120	130	150
J	208	292	332	358	396
K	105	146	166	179	198
L	≥60	≥85	≥95	≥102	≥111
M	100	100	100	160	160
N	40	40	40	60	60

## RAO2-F



RAO2-F	Ø32 x Ø92	Ø57 x Ø137	Ø76 x Ø156	Ø89 x Ø169	Ø108 x Ø188
A	500-6000				
B	287	382 (412**)	456 (451**)	500	578
C	32	57	76	89	108
D	92	137	156	169	188
E	10	18	20	20	20
F	A-160	A-230	A-260	A-280	A-310
G	50	70	70	70	70
J	95	145 (175**)	200 (195**)	231	290
L	60	85	95	≥102	≥111
M	100	100	100	160	160
N	40	40	40	60	60
N	25	30	30	30	35

## RAO3-F



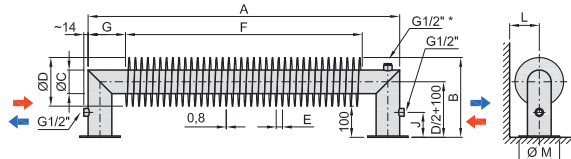
RAO3-F	Ø32 x Ø92	Ø57 x Ø137	Ø76 x Ø156	Ø89 x Ø169	Ø108 x Ø188
A	500-6000				
B	382	527 (587**)	656 (646**)	731	868
C	32	57	76	89	108
D	92	137	156	169	188
E	10	18	20	20	20
F	A-220	A-300	A-380	A-420	A-480
G	110	150	190	210	240
J	190	290 (350**)	400 (390**)	462	580
K	95	145 (175**)	200 (195**)	231	290
L	≥60	≥85	≥95	≥102	≥111
M	100	100	100	160	160
N	40	40	40	60	60

Dimension tolerance: **F** (fins length) +/- 15 mm / **J** (connection spacing) +/- 2,5 mm

\* airvent valve \*\* stainless steel construction, only ø32, 57 and 76 mm

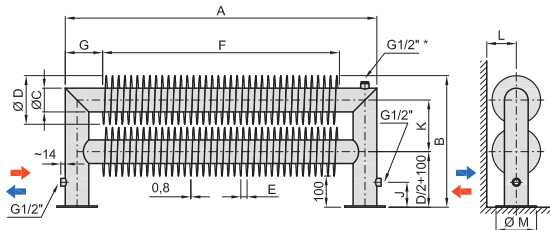
# Spiral Horizontal - SELFSTANDING

## RAT1-S



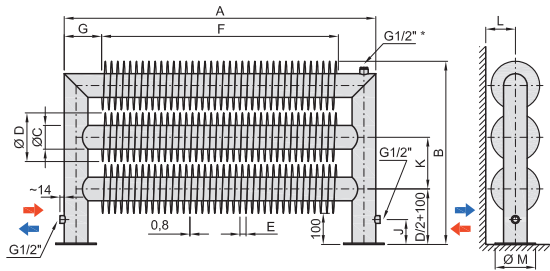
RAT1-S	Ø32 x Ø92	Ø57 x Ø137	Ø76 x Ø156	Ø89 x Ø169	Ø108 x Ø188
A	500-6000				
B	192	237	256	269	288
C	32	57	76	89	108
D	92	137	156	169	188
E	10	18	20	20	20
F	A-130	A-220	A-240	A-260	A-300
G	65	110	120	130	150
J	80	80	80	80	80
L	≥60	≥85	≥95	≥102	≥111
M	76	130	130	150	150
N	25	30	30	30	35

## RAT2-S



RAT2-S	Ø32 x Ø92	Ø57 x Ø137	Ø76 x Ø156	Ø89 x Ø169	Ø108 x Ø188
A	500-6000				
B	297	383	422	448	486
C	32	57	76	89	108
D	92	137	156	169	188
E	10	18	20	20	20
F	A-130	A-220	A-240	A-260	A-300
G	65	110	120	130	150
J	80	80	80	80	80
K	105	146	166	179	198
L	≥60	≥85	≥95	≥102	≥111
M	76	130	130	150	150
N	-	-	-	-	-

## RAT3-S



RAT3-S	Ø32 x Ø92	Ø57 x Ø137	Ø76 x Ø156	Ø89 x Ø169	Ø108 x Ø188
A	500-6000				
B	402	529	588	627	684
C	32	57	76	89	108
D	92	137	156	169	188
E	10	18	20	20	20
F	A-130	A-220	A-240	A-260	A-300
G	65	110	120	130	150
J	80	80	80	80	80
K	105	146	166	179	198
L	≥60	≥85	≥95	≥102	≥111
M	76	130	130	150	150
N	-	-	-	-	-

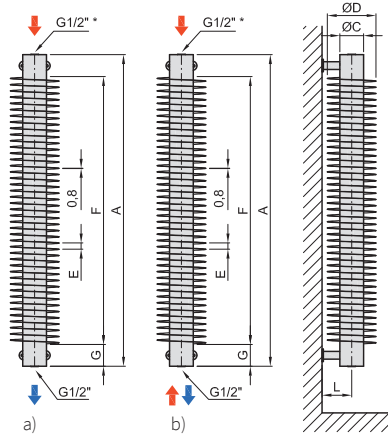
Dimension tolerance: **F** (fins length) +/- 15 mm / **J** (connection spacing) +/- 2,5 mm

\* airvent valve \*\* stainless steel construction, only ø32, 57 and 76 mm



# Spiral Vertical - WALL

## RA1-V

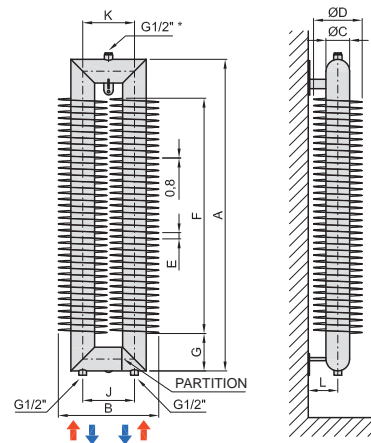


The unit does not have an air-vent valve, it is necessary to vent on the upper inlet pipe a) or use a single-point valve b)

	RA1-V	Ø32 x Ø92	Ø57 x Ø137	Ø76 x Ø156	Ø89 x Ø169	Ø108 x Ø188
Dimensions [mm]	A	500-2500				
	B	-	-	-	-	-
	C	32	57	76	89	108
	D	92	137	156	169	188
	E	10	18	20	20	20
	F	A-100	A-140	A-140	A-140	A-140
	G	50	70	70	70	70
	J	-	-	-	-	-
	K	-	-	-	-	-
	L	60	85	95	102	111
	N	40	40	40	60	60

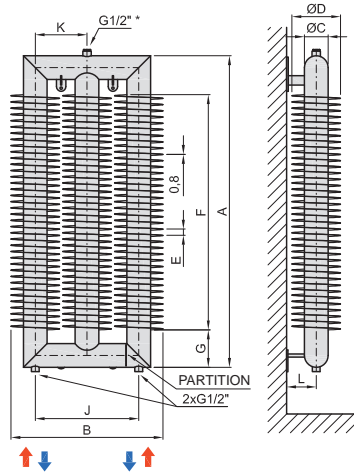
Note: option b) is not available for the Ø32 mm

## RAT2-V



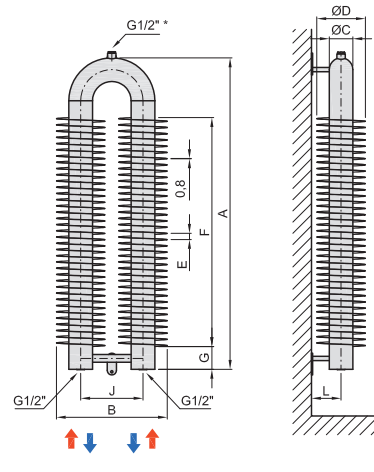
	RAT2-V	Ø32 x Ø92	Ø57 x Ø137	Ø76 x Ø156	Ø89 x Ø169	Ø108 x Ø188
Dimensions [mm]	A	500-2500				
	B	197	283	322	348	386
	C	32	57	76	89	108
	D	92	137	156	169	188
	E	10	18	20	20	20
	F	A-130	A-220	A-240	A-260	A-300
	G	65	110	120	130	150
	J	103	146	166	179	198
	K	105	146	166	179	198
	L	60	85	95	102	111
	N	40	40	40	60	60

## RAT3-V



	RAT3-V	Ø32 x Ø92	Ø57 x Ø137	Ø76 x Ø156	Ø89 x Ø169	Ø108 x Ø188
Dimensions [mm]	A	500-2500				
	B	302	429	488	527	584
	C	32	57	76	89	108
	D	92	137	156	169	188
	E	10	18	20	20	20
	F	A-130	A-220	A-240	A-260	A-300
	G	65	110	120	130	150
	J	208	292	332	358	396
	K	105	146	166	179	198
	L	60	85	95	102	111
	N	40	40	40	60	60

## RAO2-V



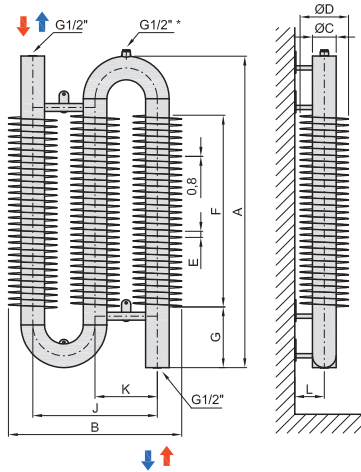
	RAO2-V	Ø32 x Ø92	Ø57 x Ø137	Ø76 x Ø156	Ø89 x Ø169	Ø108 x Ø188
Dimensions [mm]	A	500-2500				
	B	187	282 (312**)	356 (351**)	400	478
	C	32	57	76	89	108
	D	92	137	156	169	188
	E	10	18	20	20	20
	F	A-160	A-230	A-260	A-280	A-320
	G	50	70	70	70	70
	J	95	145 (175**)	200 (195**)	231	290
	K	-	-	-	-	-
	L	60	85	95	102	111
	N	40	40	40	60	60

Dimension tolerance: **F** (fins length) +/- 15 mm / **J** (connection spacing) +/- 2,5 mm

\*airvent valve \*\* stainless steel construction, only Ø32, 57 and 76 mm

# Spiral Vertical - WALL

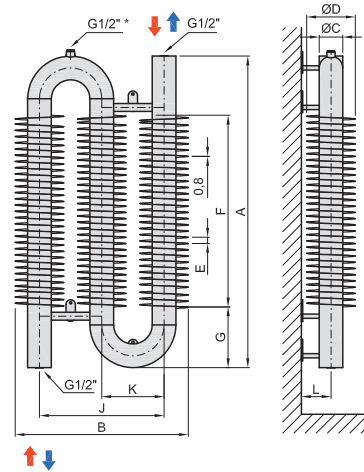
## RAO3-D



The unit does not have an air-vent valve on top inlet, it is necessary to vent on the inlet pipe

RAO3-D		Ø32 x Ø92	Ø57 x Ø137	Ø76 x Ø156	Ø89 x Ø169	Ø108 x Ø188
Dimensions [mm]	A	500-2500				
	B	282	427 (487**)	556 (546**)	631	768
	C	32	57	76	89	108
	D	92	137	156	169	188
	E	10	18	20	20	20
	F	A-220	A-300	A-380	A-420	A-500
	G	110	150	190	210	250
	J	190	290 (350**)	400 (390**)	462	580
	K	95	145 (175**)	200 (195**)	231	290
	L	60	85	95	102	111
	N	40	40	40	60	60

## RAO3-B



The unit does not have an air-vent valve on top inlet, it is necessary to vent on the inlet pipe

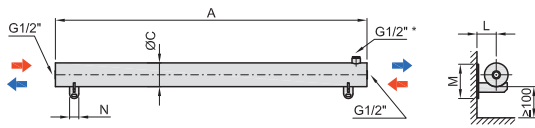
RAO3-B		Ø32 x Ø92	Ø57 x Ø137	Ø76 x Ø156	Ø89 x Ø169	Ø108 x Ø188
Dimensions [mm]	A	500-2500				
	B	282	427 (487**)	556 (546**)	631	768
	C	32	57	76	89	108
	D	92	137	156	169	188
	E	10	18	20	20	20
	F	A-220	A-300	A-380	A-420	A-500
	G	110	150	190	210	250
	J	190	290 (350**)	400 (390**)	462	580
	K	95	145 (175**)	200 (195**)	231	290
	L	60	85	95	102	111
	N	40	40	40	60	60

Dimension tolerance: **F** (fins length) +/- 15 mm / **J** (connection spacing) +/- 2,5 mm

\* airvent valve \*\* stainless steel construction, only ø32, 57 and 76 mm

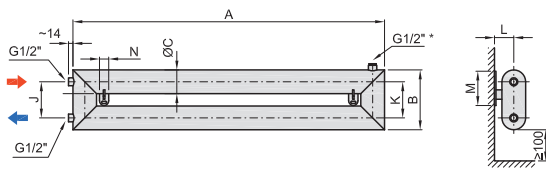
# Spiral Horizontal without fins - WALL

## HRA1-W



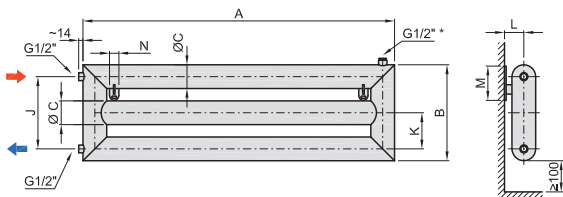
HRA1-W	Ø32 x Ø92	Ø57 x Ø137	Ø76 x Ø156	Ø89 x Ø169	Ø108 x Ø188
Dimensions [mm]					
A	500-6000				
B	-	-	-	-	-
C	32	57	76	89	108
J	-	-	-	-	-
L	30	51	60	72	81
M	90	100	110	115	125
N	25	30	30	30	35

## HRAT2-W



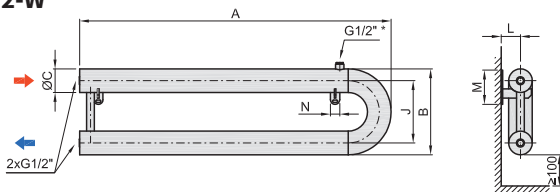
HRAT2-W	Ø32 x Ø92	Ø57 x Ø137	Ø76 x Ø156	Ø89 x Ø169	Ø108 x Ø188
Dimensions [mm]					
A	500-6000				
B	104	154	192	238	276
C	32	57	76	89	108
J	70	97	116	149	168
K	72	97	116	149	168
L	30	51	60	72	81
M	90	100	110	115	125
N	25	30	30	30	35

## HRAT3-W



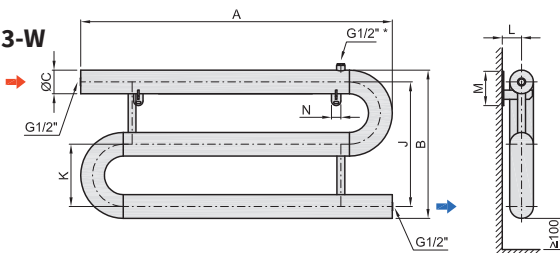
HRAT3-W	Ø32 x Ø92	Ø57 x Ø137	Ø76 x Ø156	Ø89 x Ø169	Ø108 x Ø188
Dimensions [mm]					
A	500-6000				
B	176	251	308	387	444
C	32	57	76	89	108
J	142	194	232	298	336
K	72	97	116	149	168
L	30	51	60	72	81
M	90	100	110	115	125
N	25	30	30	30	35

## HRAO2-W



HRAO2-W	Ø32 x Ø92	Ø57 x Ø137	Ø76 x Ø156	Ø89 x Ø169	Ø108 x Ø188
Dimensions [mm]					
A	500-6000				
B	127	202 (232**)	276 (271**)	320	398
C	32	57	76	89	108
J	95	145 (175**)	200 (195**)	231	290
L	30	51	60	72	81
M	90	100	110	115	125
N	25	30	30	30	35

## HRAO3-W



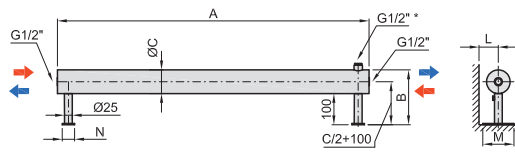
HRAO3-W	Ø32 x Ø92	Ø57 x Ø137	Ø76 x Ø156	Ø89 x Ø169	Ø108 x Ø188
Dimensions [mm]					
A	500-6000				
B	222	347 (407**)	476 (466**)	551	688
C	32	57	76	89	108
J	190	290 (350**)	400 (390**)	462	580
K	95	145 (175**)	200 (195**)	231	290
L	30	51	60	72	81
M	90	100	110	115	125
N	25	30	30	30	35

Dimension tolerance: **F** (fins length) +/- 15 mm / **J** (connection spacing) +/- 2,5 mm

\* airvent valve \*\* stainless steel construction, only ø32, 57 and 76 mm

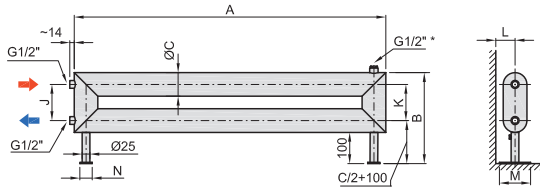
# Spiral Horizontal without fins - FLOOR

## HRA1-F



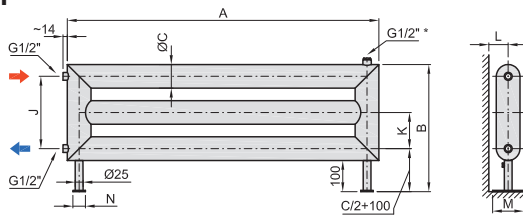
HRA1-F	Ø32 x Ø92	Ø57 x Ø137	Ø76 x Ø156	Ø89 x Ø169	Ø108 x Ø188	
Dimensions [mm]	A	500-6000				
	B	132	157	176	189	208
	C	32	57	76	89	108
	J	-	-	-	-	-
	L	≥62	≥62	≥62	≥92	≥92
	M	100	100	100	160	160
	N	40	40	40	60	60

## HRAT2-F



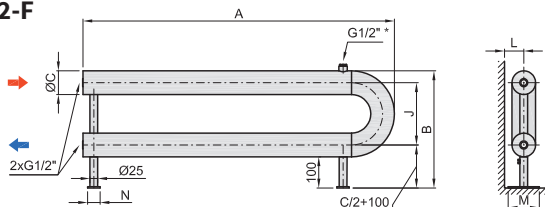
HRAT2-F	Ø32 x Ø92	Ø57 x Ø137	Ø76 x Ø156	Ø89 x Ø169	Ø108 x Ø188	
Dimensions [mm]	A	500-6000				
	B	204	254	292	338	376
	C	32	57	76	89	108
	J	70	97	116	149	168
	K	72	97	116	149	168
	L	≥62	≥62	≥62	≥92	≥92
	M	100	100	100	160	160
	N	40	40	40	60	60

## HRAT3-F



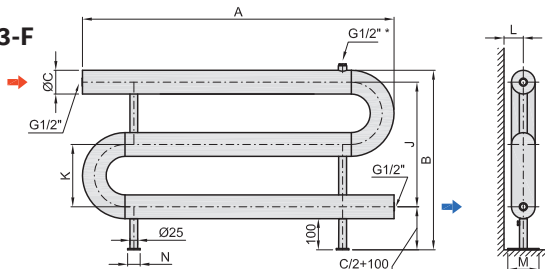
HRAT3-F	Ø32 x Ø92	Ø57 x Ø137	Ø76 x Ø156	Ø89 x Ø169	Ø108 x Ø188	
Dimensions [mm]	A	500-6000				
	B	276	351	408	487	544
	C	32	57	76	89	108
	J	142	194	232	298	336
	K	72	97	116	149	168
	L	≥62	≥62	≥62	≥92	≥92
	M	100	100	100	160	160
	N	40	40	40	60	60

## HRAO2-F



HRAO2-F	Ø32 x Ø92	Ø57 x Ø137	Ø76 x Ø156	Ø89 x Ø169	Ø108 x Ø188	
Dimensions [mm]	A	500-6000				
	B	227	302 (332**)	376 (371**)	420	498
	C	32	57	76	89	108
	J	95	145 (175**)	200 (195**)	231	290
	L	≥62	≥62	≥62	≥92	≥92
	M	100	100	100	160	160
	N	40	40	40	60	60

## HRAO3-F



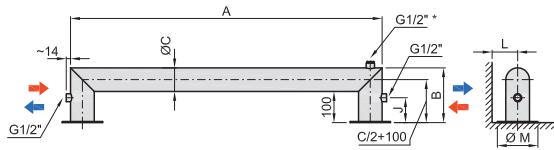
HRAO3-F	Ø32 x Ø92	Ø57 x Ø137	Ø76 x Ø156	Ø89 x Ø169	Ø108 x Ø188	
Dimensions [mm]	A	500-6000				
	B	322	447 (507**)	576 (566**)	651	788
	C	32	57	76	89	108
	J	190	290 (350**)	400 (390**)	462	580
	K	95	145 (175**)	200 (195**)	231	290
	L	≥62	≥62	≥62	≥92	≥92
	M	100	100	100	160	160
	N	40	40	40	60	60

Dimension tolerance: **F** (fins length) +/- 15 mm / **J** (connection spacing) +/- 2,5 mm

\* airvent valve \*\* stainless steel construction, only ø32, 57 and 76 mm

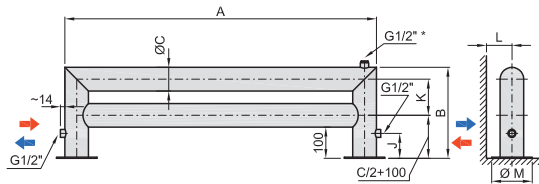
# Spiral Horizontal without fins - SELFSTANDING

## HRA1-S



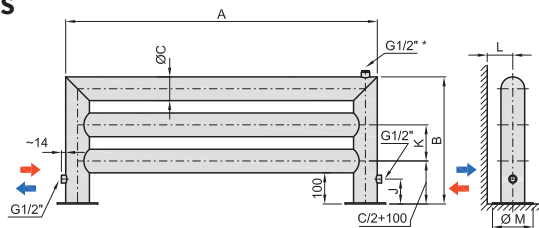
HRA1-S	Ø32 x Ø92	Ø57 x Ø137	Ø76 x Ø156	Ø89 x Ø169	Ø108 x Ø188
Dimensions [mm]					
A	500-6000				
B	132	157	176	189	208
C	32	57	76	89	108
J	80	80	80	80	80
L	≥50	≥77	≥77	≥87	≥87
M	76	130	130	150	150
N	-	-	-	-	-

## HRAT2-S



HRAT2-S	Ø32 x Ø92	Ø57 x Ø137	Ø76 x Ø156	Ø89 x Ø169	Ø108 x Ø188
Dimensions [mm]					
A	500-6000				
B	204	254	292	338	376
C	32	57	76	89	108
J	80	80	80	80	80
K	72	97	116	149	168
L	≥50	≥77	≥77	≥87	≥87
M	76	130	130	150	150
N	-	-	-	-	-

## HRAT3-S



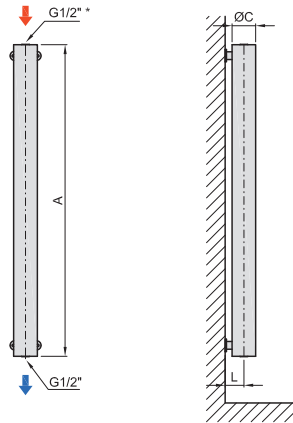
HRAT3-S	Ø32 x Ø92	Ø57 x Ø137	Ø76 x Ø156	Ø89 x Ø169	Ø108 x Ø188
Dimensions [mm]					
A	500-6000				
B	276	351	408	487	544
C	32	57	76	89	108
J	80	80	80	80	80
K	72	97	116	149	168
L	≥50	≥77	≥77	≥87	≥87
M	76	130	130	150	150
N	-	-	-	-	-

Dimension tolerance: **F** (fins length) +/- 15 mm / **J** (connection spacing) +/- 2,5 mm

\* airvent valve \*\* stainless steel construction, only ø32, 57 and 76 mm

# Spiral Vertical without fins - WALL

## HRA1-V

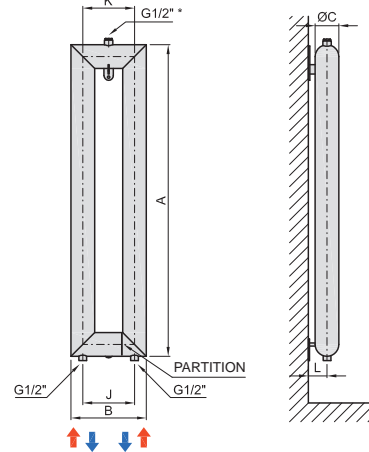


The unit does not have an air-vent valve, it is necessary to vent on the upper inlet pipe a) or use a single-point valve b)

HRA1-V		Ø32 x Ø92	Ø57 x Ø137	Ø76 x Ø156	Ø89 x Ø169	Ø108 x Ø188
Dimensions [mm]	A	500-2500				
	B	-	-	-	-	-
	C	32	57	76	89	108
	J	-	-	-	-	-
	K	-	-	-	-	-
	L	30	51	60	72	81

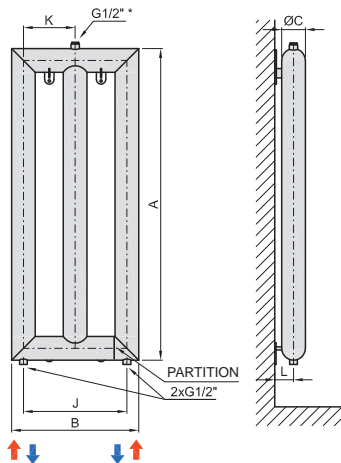
Note: option b) is not available for the ø32 mm

## HRAT2-V



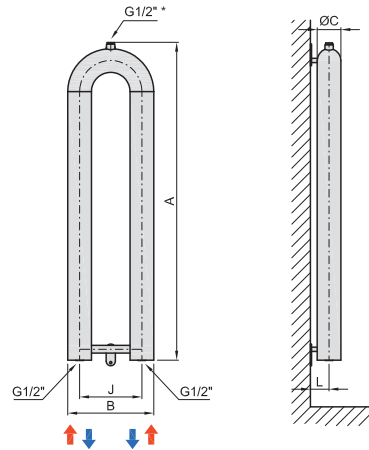
HRAT2-V		Ø32 x Ø92	Ø57 x Ø137	Ø76 x Ø156	Ø89 x Ø169	Ø108 x Ø188
Dimensions [mm]	A	500-2500				
	B	104	154	192	238	276
	C	32	57	76	89	108
	J	70	97	116	149	168
	K	72	97	116	149	168
	L	30	51	60	72	81

## HRAT3-V



HRAT3-V		Ø32 x Ø92	Ø57 x Ø137	Ø76 x Ø156	Ø89 x Ø169	Ø108 x Ø188
Dimensions [mm]	A	500-2500				
	B	176	251	308	387	444
	C	32	57	76	89	108
	J	142	194	232	298	336
	K	72	97	116	149	168
	L	30	51	60	72	81

## HRAO2-V



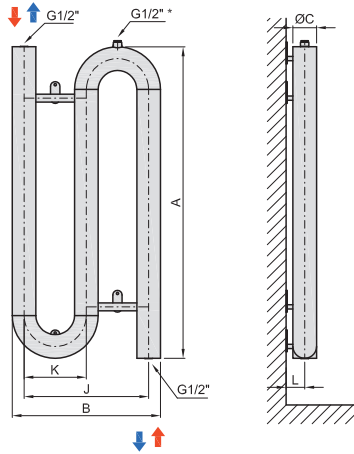
HRAO2-V		Ø32 x Ø92	Ø57 x Ø137	Ø76 x Ø156	Ø89 x Ø169	Ø108 x Ø188
Dimensions [mm]	A	500-2500				
	B	127	202 (232**)	276 (271**)	320	398
	C	32	57	76	89	108
	J	95	145 (175**)	200 (195**)	231	290
	K	-	-	-	-	-
	L	30	51	60	72	81

Dimension tolerance: **F** (fins length) +/- 15 mm / **J** (connection spacing) +/- 2,5 mm

\* airvent valve \*\* stainless steel construction, only ø32, 57 and 76 mm

# Spiral Vertical without fins - WALL

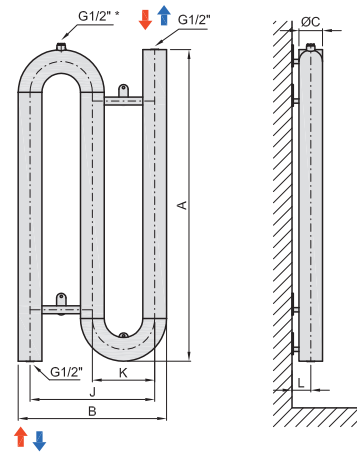
HRA03-D



The unit does not have an air-vent valve on top inlet, it is necessary to vent on the inlet pipe

	HRA03-D	Ø32 x Ø92	Ø57 x Ø137	Ø76 x Ø156	Ø89 x Ø169	Ø108 x Ø188
Dimensions [mm]	A			500-2500		
	B	222	347 (407**)	476 (466**)	551	688
	C	32	57	76	89	108
	J	190	290 (350**)	400 (390**)	462	580
	K	95	145 (175**)	200 (195**)	231	290
	L	30	51	60	72	81

HRA03-B



The unit does not have an air-vent valve on top inlet, it is necessary to vent on the inlet pipe

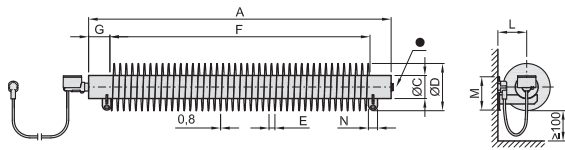
	HRA03-B	Ø32 x Ø92	Ø57 x Ø137	Ø76 x Ø156	Ø89 x Ø169	Ø108 x Ø188
Dimensions [mm]	A			500-2500		
	B	222	347 (407**)	476 (466**)	551	688
	C	32	57	76	89	108
	J	190	290 (350**)	400 (390**)	462	580
	K	95	145 (175**)	200 (195**)	231	290
	L	30	51	60	72	81

Dimension tolerance: **F** (fins length) +/- 15 mm / **J** (connection spacing) +/- 2,5 mm

\* airvent valve \*\* stainless steel construction, only ø32, 57 and 76 mm

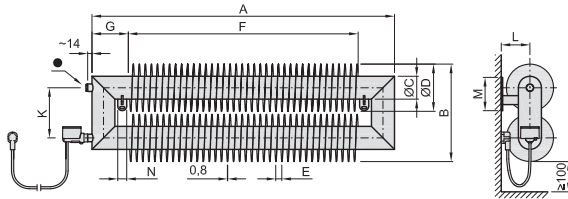
# Spiral Electro Horizontal - WALL

## RA1-W



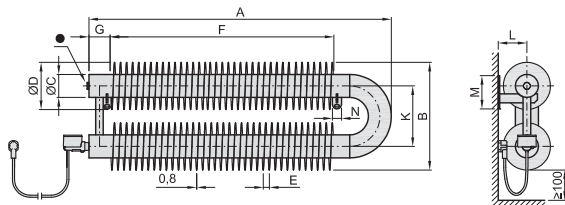
RA1-W	Ø57 × Ø137	Ø76 × Ø156
A	500-2000	
B	-	-
C	57	76
D	137	156
E	18	20
F	A-140	A-140
G	70	70
K	-	-
L	85	95
M	100	110
N	30	30

## RAT2-W



RAT2-W	Ø57 × Ø137	Ø76 × Ø156
A	500-2000	
B	283	322
C	57	76
D	137	156
E	18	20
F	A-220	A-240
G	110	120
K	146	166
L	85	95
M	100	110
N	30	30

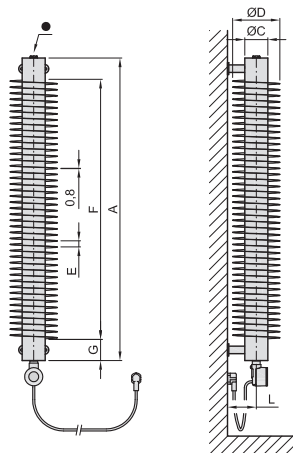
## RAO2-W



RAO2-W	Ø57 × Ø137	Ø76 × Ø156
A	500-2000	
B	282	356
C	57	76
D	137	156
E	18	20
F	A-230	A-260
G	70	70
K	145	200
L	85	95
M	100	110
N	30	30

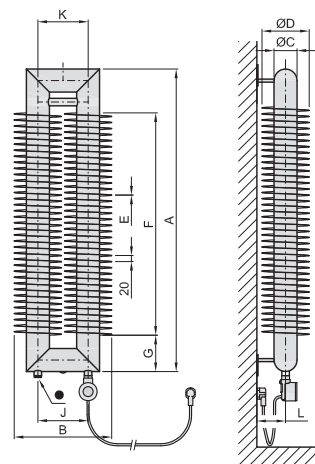
# Spiral Electro Vertical - WALL

## RA1-V



RA1-V	Ø57 × Ø137	Ø76 × Ø156
A	500-2000	
B	-	-
C	57	76
D	137	156
E	18	20
F	A-140	A-140
G	70	70
J	-	-
K	-	-
L	85	95
N	30	30

## RAT2-V



RAT2-V	Ø57 × Ø137	Ø76 × Ø156
A	500-2000	
B	283	322
C	57	76
D	137	156
E	18	20
F	A-240	A-265
G	110	120
J	146	166
K	146	166
L	85	95
N	30	30

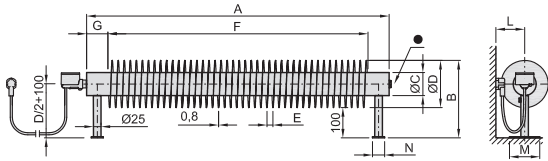
Dimension tolerance: **F** (fin length) +/- 15 mm / **J** (connection spacing) +/- 2,5 mm

• closing plug - must not be removed



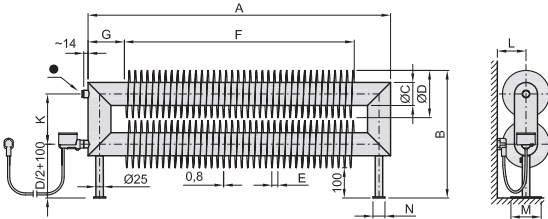
# Spiral Electro Horizontal - FLOOR

## RA1-F



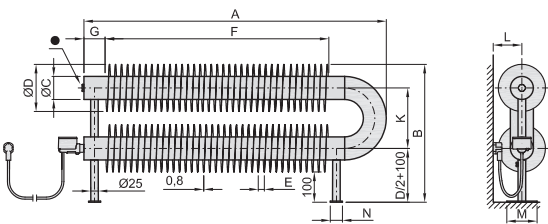
RA1-F	Ø57 × Ø137	Ø76 × Ø156
A	500-2000	
B	237	256
C	57	76
D	137	156
E	18	20
F	A-140	A-140
G	70	70
K	-	-
L	≥85	≥95
M	100	100
N	40	40

## RAT2-F



RAT2-F	Ø57 × Ø137	Ø76 × Ø156
A	500-2000	
B	383	422
C	57	76
D	137	156
E	18	20
F	A-220	A-240
G	110	120
K	146	166
L	≥85	≥95
M	100	100
N	40	40

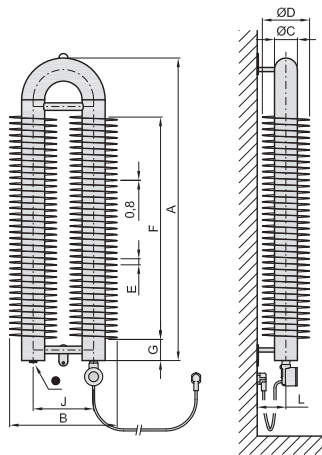
## RAO2-F



RAO2-F	Ø57 × Ø137	Ø76 × Ø156
A	500-2000	
B	382	456
C	57	76
D	137	156
E	18	20
F	A-230	A-260
G	70	70
K	145	200
L	≥85	≥95
M	100	100
N	40	40

# Spiral Electro Vertical - WALL

## RAO2-V



RAO2-V	Ø57 × Ø137	Ø76 × Ø156
A	500-2000	
B	282	356
C	57	76
D	137	156
E	18	20
F	A-235	A-265
G	70	70
J	145	200
K	-	-
L	85	95
N	30	30

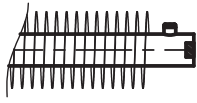
Dimension tolerance: **F** (fin length) +/- 15 mm / **J** (connection spacing) +/- 2,5 mm

• closing plug - must not be removed

# Connection options for spiral radiators

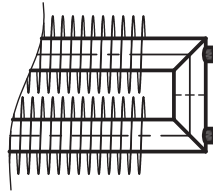
## Standard ways of connecting spiral radiators

Standard connection S1, S2, S3 with no additional charge on top of the price of the radiator.



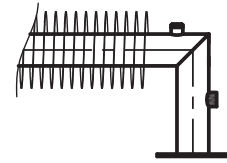
**S1**

Standard connection for RA1 and RAO radiators.



**S2**

Standard connection for RAT radiators.

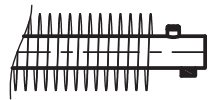


**S3**

Standard connection for RA1 and RAT self-standing radiators.

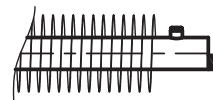
## Atypical ways of connecting spiral radiators – (additional charge for change in connection)

Atypical ways of connection can be combined with changes in the connection threads (G3/8", G1/2", G3/4", G1") after consultation with the sales department.



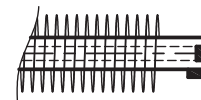
**A1**

Atypical connection for RA1, RAT and RAO radiators.



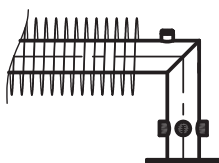
**A2**

Atypical connection for RA1 and RAO radiators with a diameter of 57, 76, 89 and 108 mm.



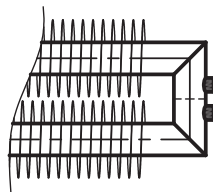
**A3**

Atypical connection for RA1 radiators with a diameter of 57, 76, 89 and 108 mm.



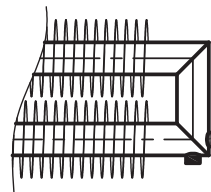
**A4**

Atypical connection for self-standing RA1 and RAT radiators. Any movement of the connection must always be only by an angle of 90°.



**A5**

Atypical connection for RAT radiators. Min. pitch of the connection 50 mm.



**A6**

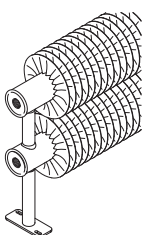
Atypical connection for RAT radiators.

Should you be interested in special connections please contact the sales department of ISAN Radiátory s.r.o. for a specification of the technical parameters. Should it not be stated otherwise, the atypical connections are valid for all of the manufactured diameters 32, 57, 76, 89 and 108 mm.

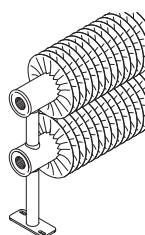
## Connection thread options

Units with greater heating medium flows require a larger-diameter connection thread. To meet this requirement, we offer radiators ø57, 76, 89 and 108 also with a G3/4" and G 1" connection thread (instead of the standard G1/2").

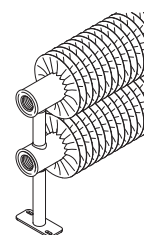
**Example: RA02 57x137**



**thread G1/2"**

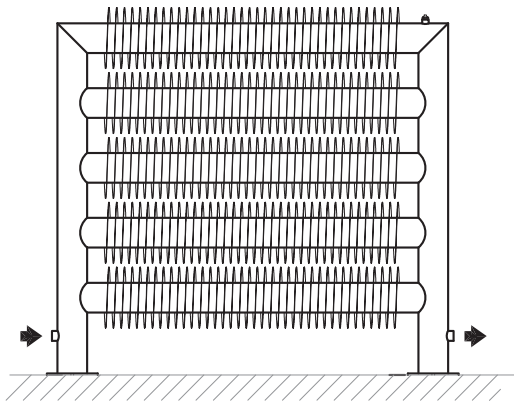


**thread G3/4"**

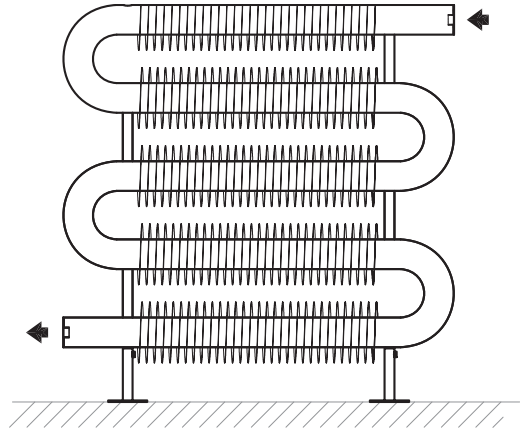


**thread G1"**

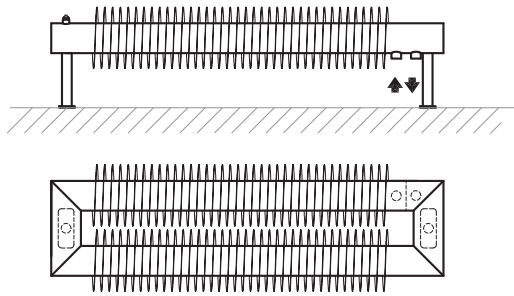
# Next atypical designs of radiators



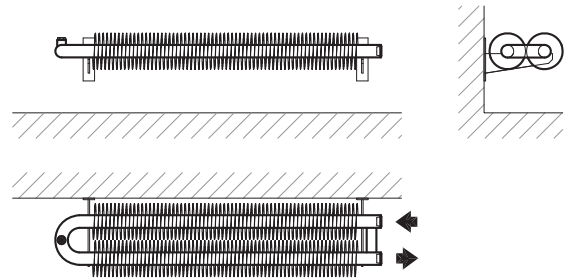
RAT5 76/156 SELF-STANDING



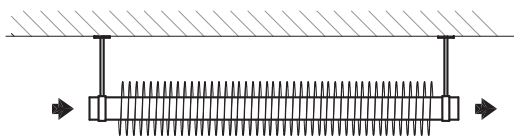
RAO5 57/137 ON THE FLOOR



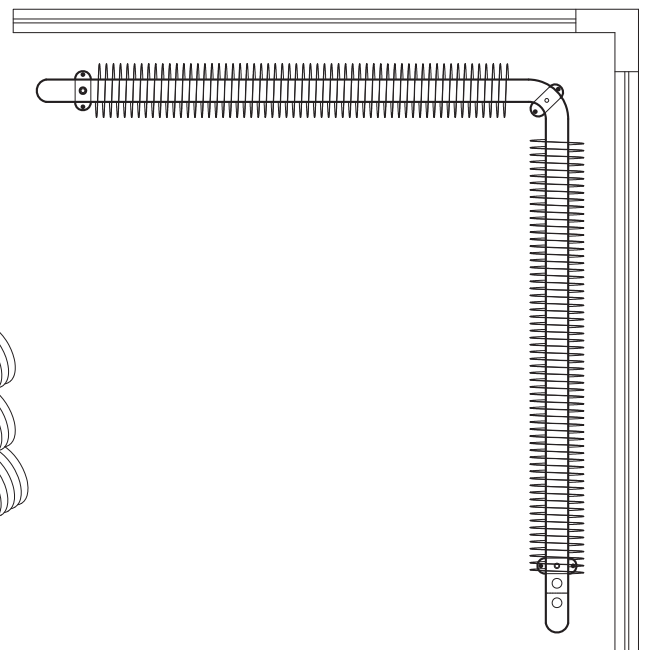
RAT2 76/156 TO THE FLOOR HORIZONTALLY



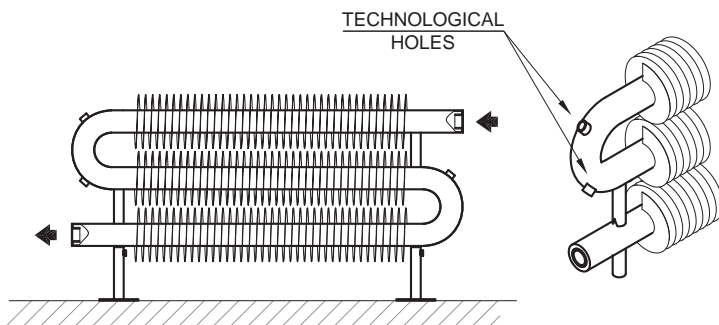
RAO2 32/92 TO THE WALL HORIZONTALLY



RA1 57/137 UNDER CEILING



RAO2 57/137 TO THE FLOOR – BROKEN LINE SHAPE



RAO3 57/137 ON THE FLOOR – GALVANIZED

# How to order Spiral radiators

## Radiator code example



Radiator code example:

**Z T 2 0 3 2 1 0 0 0 W - 0 1 -**

1	2	3	4	5	6	7	8	9	10	11	12	13	14	15
<b>Z</b>	<b>T</b>	<b>2</b>	<b>0</b>	<b>3</b>	<b>2</b>	<b>1</b>	<b>0</b>	<b>0</b>	<b>0</b>	<b>W</b>	<b>-</b>	<b>0</b>	<b>1</b>	<b>-</b>
SPIRAL TYPE		TUBE DIAMETER [MM]			LENGTH [MM]					MOUNTING	DESIGN	COLOUR CODE		ATYPICAL

**Order** → RAT2 Spiral finned tube radiator 32x92, length 1000 mm, wall-mounted, for connection to the central heating system

## Code explanatory notes

Position 1, 2, 3 - Spiral type		
SPIRAL	e.g. ZT2	<b>Z-1</b> model RA1 single-strand Spiral <b>ZT2</b> model RAT2 two-strand Spiral, angular shape <b>ZT3</b> model RAT3 three-strand Spiral, angular shape <b>ZO2</b> model RAO2 two-strand Spiral, with elbow <b>ZO3</b> model RAO3 three-strand Spiral, with elbows
SPIRAL WITHOUT FINS	e.g. H02	<b>H-1</b> model HRA1 single-strand Spiral without fins <b>HT2</b> model HRAT2 two-strand Spiral without fins, angular shape <b>HT3</b> model HRAT3 three-strand Spiral without fins, angular shape <b>HO2</b> model HRAO2 two-strand Spiral without fins, with elbow <b>HO3</b> model HRAO3 three-strand Spiral without fins, with elbows
SPIRAL ELECTRO	e.g. ZO2	<b>Z-1</b> model RA1 single-strand Spiral <b>ZT2</b> model RAT2 two-strand Spiral, angular shape <b>ZO2</b> model RAO2 two-strand Spiral, with elbow
Position 4, 5, 6 - Tube diameter		
SPIRAL	e.g. 076	<b>032, 057, 076, 089, 108</b> mm - diameter of pipes, standard and galvanized models
SPIRAL WITHOUT FINS		<b>032, 057, 076</b> - diameter of pipes, stainless steel models
SPIRAL ELECTRO	e.g. 057	<b>057, 076</b> mm - diameter of pipe
Position 7, 8, 9, 10 - Length (horizontal models), height (vertical models)		
SPIRAL SPIRAL WITHOUT FINS	e.g. 1200	Horizontal models <b>500, 600, 700....., 3000</b> mm in step 100 mm <b>3200, 3400, 3600, ..., 6000</b> mm in step 200 mm  Vertical models <b>500, 600, 700, ..., 2500</b> mm in step 100 mm
SPIRAL ELECTRO	e.g. 2000	Horizontal models <b>500, 750, 1000, 1250, 1500, 1750, 2000</b> mm  Vertical models <b>500, 750, 1000, 1250, 1500, 1750, 2000</b> mm
Position 11 - Mounting		
SPIRAL SPIRAL WITHOUT FINS SPIRAL ELECTRO	e.g. W	Horizontal models <b>F</b> floor mounting on stands (all models) <b>S</b> floor mounting, self-standing variant of Spiral only RAT1, RAT2, RAT3 (not available for Electro models) <b>W</b> wall mounting on brackets (all models)  Vertical models <b>V</b> wall mounting in vertical position (all models) <b>B</b> RAO3, HRAO3 - vertical mounting on the wall, LEFT <b>D</b> RAO3, HRAO3 - vertical mounting on the wall, RIGHT
Position 12 - Design		
SPIRAL SPIRAL WITHOUT FINS	e.g. -	- standard connection to the hot water heating system with forced circulation
SPIRAL ELECTRO	e.g. M	<b>Z Z-heating rod</b> , electrical connection without regulator <b>M Mini PW controller</b> , electrical connection with the Mini PW controller <b>P Vision controller</b> , electrical connection with the Vision controller, Gateway is included in the delivery, suitable for vertical models <b>E Nexus system</b> - electrical connection with various regulators - select and separately order a <b>Solo, Rio, Rio Wi-Fi, Neo</b> or <b>Neo Wi-Fi</b> controller (see pages 15-16) - version Neo and Neo Wi-Fi suitable for vertical versions
Position 13, 14 - Colour code		
SPIRAL SPIRAL WITHOUT FINS SPIRAL ELECTRO	e.g. 01	<b>01</b> standard colour RAL9016, snow white <b>XX</b> see ISAN colour chart at the page 38 (e.g. code 72 - colour S13, sandstone, texture) <b>81</b> stainless steel (available only for Spiral and Spiral without fins Ø32, Ø57 and Ø76 mm) <b>99</b> other colour options, (outside the ISAN palette)
Position 15 - Atypical		
		- standard design <b>N</b> atypical radiator

# Colour Reference Chart



colour series **RAL 9016**  
 shade snow/traffic white  
 finish -  
 extra charge -  
 order code 01



colour series **S09**  
 shade snow white  
 finish texture  
 extra charge ✓  
 order code 68



colour series **RAL 9001**  
 shade ivory/cream  
 finish -  
 extra charge ✓  
 order code 04



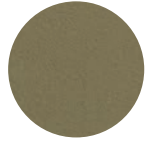
colour series **S31**  
 shade champagne  
 finish metallic  
 extra charge ✓  
 order code 25



colour series **RAL 9018**  
 shade papyrus white  
 finish -  
 extra charge ✓  
 order code 14



colour series **S08**  
 shade ivory  
 finish texture  
 extra charge ✓  
 order code 67



colour series **S27**  
 shade khaki  
 finish texture  
 extra charge ✓  
 order code 21



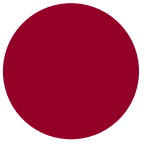
colour series **S36**  
 shade antique gold  
 finish metallic  
 extra charge ✓  
 order code 48



colour series **S32**  
 shade pink coral  
 finish texture  
 extra charge ✓  
 order code 26



colour series **RAL 3002**  
 shade fiery red  
 finish -  
 extra charge ✓  
 order code 08



colour series **S34**  
 shade ruby  
 finish -  
 extra charge ✓  
 order code 28



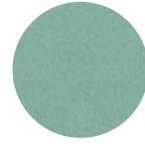
colour series **S13**  
 shade sandstone  
 finish texture  
 extra charge ✓  
 order code 72



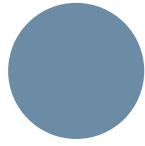
colour series **S28**  
 shade gold olive  
 finish texture  
 extra charge ✓  
 order code 22



colour series **RAL 6021**  
 shade linden green  
 finish -  
 extra charge ✓  
 order code 06



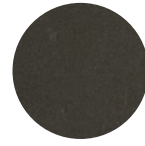
colour series **S29**  
 shade aquamarine  
 finish metallic  
 extra charge ✓  
 order code 23



colour series **RAL 5014**  
 shade pigeon blue  
 finish -  
 extra charge ✓  
 order code 07



colour series **S30**  
 shade sapphire  
 finish texture  
 extra charge ✓  
 order code 24



colour series **S33**  
 shade lava ash  
 finish texture  
 extra charge ✓  
 order code 27



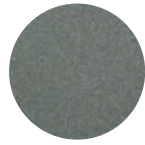
colour series **S03**  
 shade copper  
 finish metallic  
 extra charge ✓  
 order code 62



colour series **S19**  
 shade brass  
 finish metallic  
 extra charge ✓  
 order code 83



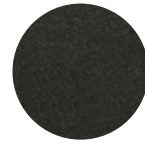
colour series **S38**  
 shade dark grey  
 finish texture  
 extra charge ✓  
 order code 50



colour series **S05**  
 shade silver  
 finish metallic  
 extra charge ✓  
 order code 64



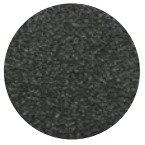
colour series **S37**  
 shade light grey  
 finish texture  
 extra charge ✓  
 order code 49



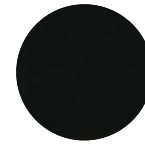
colour series **S02**  
 shade anthracite  
 finish metallic  
 extra charge ✓  
 order code 61



colour series **S35**  
 shade cinnamon  
 finish texture  
 extra charge ✓  
 order code 29



colour series **S10**  
 shade slate  
 finish texture  
 extra charge ✓  
 order code 69



colour series **RAL 9005**  
 shade black  
 finish -  
 extra charge ✓  
 order code 19

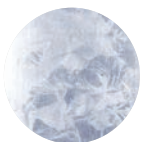


colour series **S40**  
 shade black velvet  
 finish matt  
 extra charge ✓  
 order code 51

## Other surcharges

- other K7 CLASSIC chart colours
- anti-corrosion finish

## Surface treatment

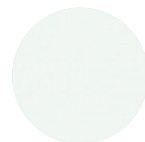


colour series **galvanized**  
 order code 90



colour series **inox**  
 order code 81

## Special treatment



colour series **S41**  
 shade white  
 finish antibacterial\*  
 extra charge ✓  
 order code 88



colour series **S20**  
 shade transparent paint  
 finish transparent paint  
 extra charge ✓  
 order code 84

\*A silver-ion antibacterial finish provides protection against a wide range of bacteria and mildew.





**ISAN Radiátory s.r.o**

Poříčí 26  
678 01 Blansko  
Czech Republic

**CZ**

+420 516 489 138  
obchod@isan.cz  
www.isan.cz

**SK**

+420 516 489 186  
obchod@isan.sk  
www.isan.cz

**Export**

+420 516 489 190  
sales@isan.cz  
www.isan.cz