

# SINGLE VERTICAL RIFT 24 - ELECTRIC VERSION

ALUMINIUM electric DESIGN radiator

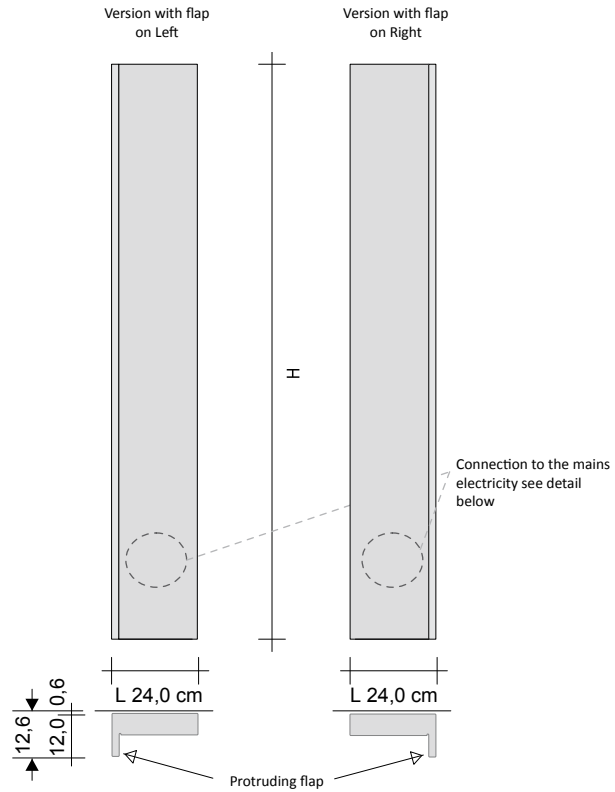

EL



## CONNECTION DIAGRAM

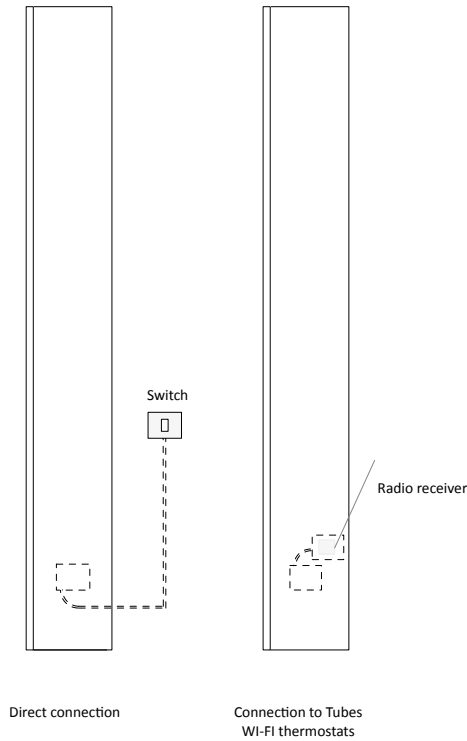

## Electric Control

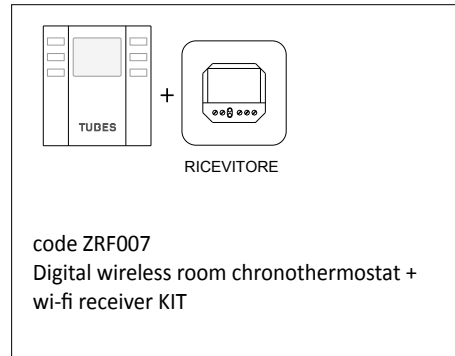

## Connection cable to the electricity mains

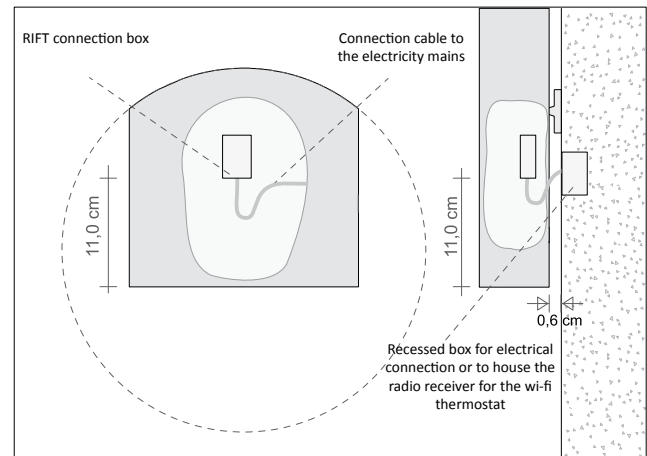

Product code **RFTV24SE#SX140901003**



RFTV24SE#SX140 Article code specified in the price table  
 9010 Colour/finish code specified in the Official TUBES COLOUR CHART  
 LEFT Flap

**ADDITIONAL COLOUR CHARGES**

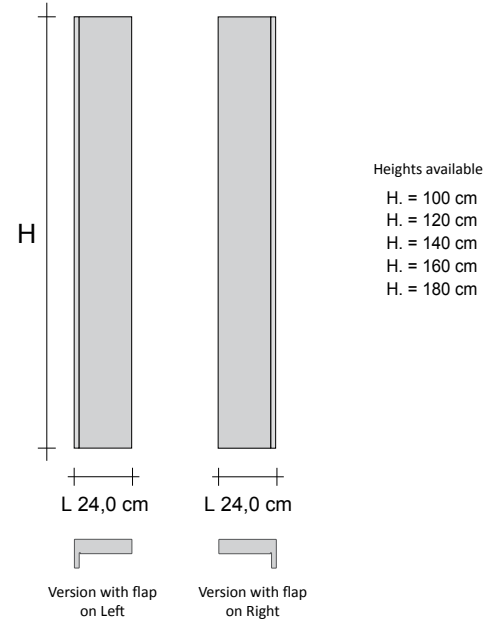
Finishes and Anodizing see page. 5 or the colour table provided at the end of this price list.



**Left and Right Single Vertical - ELECTRIC**

| Model   |   | H<br>(cm) | L<br>(cm) | Electrical<br>Resistance<br>(Watts) | Price<br>Standard White<br>Cat. C0 (€) | Price<br>Category<br>C1/C2 (€) | Price<br>Category<br>Cat. C3 (€) |
|---|---|-----------|-----------|-------------------------------------|--|--------------------------------|----------------------------------|
|  |  |           |           |                                     |  |                                |                                  |
| RFTV24SE#SX100  | RFTV24SE#DX100  | 100,0     | 24,0      | 210 W                               |  |                                |                                  |
| RFTV24SE#SX120  | RFTV24SE#DX120  | 120,0     | 24,0      | 280 W                               |  |                                |                                  |
| RFTV24SE#SX140  | RFTV24SE#DX140  | 140,0     | 24,0      | 350 W                               |  |                                |                                  |
| RFTV24SE#SX160  | RFTV24SE#DX160  | 160,0     | 24,0      | 500 W                               |  |                                |                                  |
| RFTV24SE#SX180  | RFTV24SE#DX180  | 180,0     | 24,0      | 560 W                               |  |                                |                                  |



Hook code ZAAPRFT#...



Towel rail code ZAPSRFT#...

**RIFT accessories**

| Code      | Description                  | Finishes  | Price (€) |
|-----------|------------------------------|---|-----------|
| ZAAPRFT#  | RIFT hook in PLATED brass    | Galvanic finish cat. G0, G1, G2, G3 and G5 (except brushed) |           |
| ZAPSRFT#  | Towel Rail in PLATED brass   |   |           |
| ZAAPRFTC# | RIFT hook in COLOURED brass  | Tubes Colours* cat. C0, C1, C2, C3                          |           |
| ZAPSRFTC# | Towel Rail in COLOURED brass |   |           |

\* the GRGR Chrome Grey finish is NOT available

**ELECTRIC CONTROLS**

Electric control is via the use of the ZRF007 thermostat which regulates the room temperature by interacting with up to a maximum of 5 radiators.

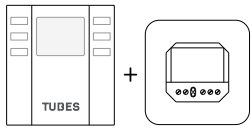
|   | Code   | Description  | Finishes | Price (€) |
|---|--------|--|----------|-----------|
|  | ZRF007 | Radio frequency Room Thermostat Kit with weekly programmer for wall mounting, wireless and certified ECOdesign. The Kit includes the wall box radio frequency receiver which must strictly be installed. | White    |           |

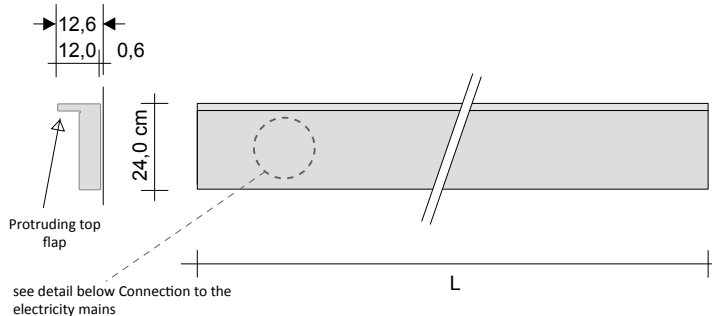

**CONNECTION DIAGRAM**

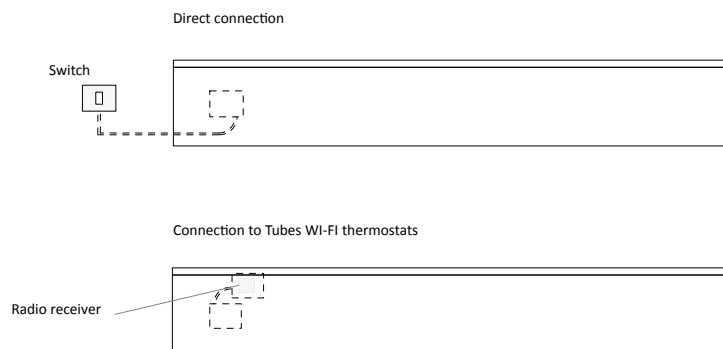

**Electric Control**

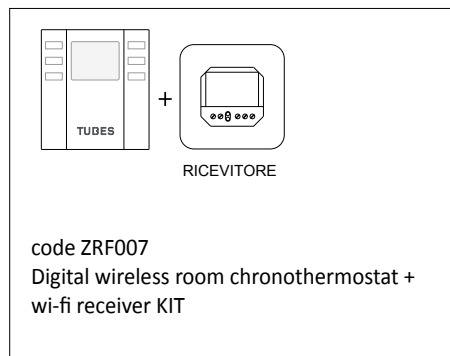

**Connection cable to the electricity mains**

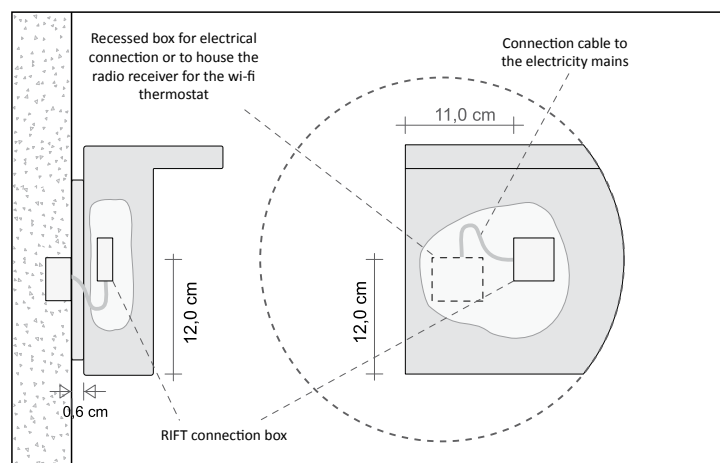

Product code **RFTO24SE#SU140901003**

|                |   |
|----------------|---|
| RFTO24SE#SU140 | Article code specified in the price table                       |
| 9010           | Colour/finish code specified in the Official TUBES COLOUR CHART |
| SU             | Flap  |

**ADDITIONAL COLOUR CHARGES**

Finishes and Anodizing see page. 5 or the colour table provided at the end of this price list.

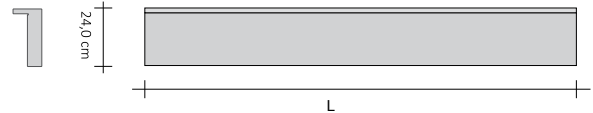

Widths available

- L. = 100 cm
- L. = 120 cm
- L. = 140 cm
- L. = 160 cm
- L. = 180 cm

**Single Horizontal - ELECTRIC version**

| Model          | H<br>(cm) | L<br>(cm) | Electrical<br>Resistance<br>(Watts) | Price<br>Standard White<br>Cat. C0 (€) | Price<br>Category<br>C1/C2 (€) | Price<br>Category<br>Cat. C3 (€) |
|----------------|-----------|-----------|-------------------------------------|--|--------------------------------|----------------------------------|
| RFTO24SE#SU100 | 24,0      | 100,0     | 210 W                               |  |                                |                                  |
| RFTO24SE#SU120 | 24,0      | 120,0     | 280 W                               |  |                                |                                  |
| RFTO24SE#SU140 | 24,0      | 140,0     | 350 W                               |  |                                |                                  |
| RFTO24SE#SU160 | 24,0      | 160,0     | 500 W                               |  |                                |                                  |
| RFTO24SE#SU180 | 24,0      | 180,0     | 560 W                               |  |                                |                                  |

Colour GRGR Chrome Grey NOT available for the RIFT model.

**RIFT accessories**

Hook code ZAAPRFT#...



RIFT shelf  
L 48 cm cod. ZAMRFT48#...  
L 60 cm cod. ZAMRFT60#...

| Code   | Description  | Finishes  | Price (€) |
|--|--|---|-----------|
| ZAAPRFT#...  | RIFT hook in PLATED brass  | Galvanic finish cat. G0, G1, G2, G3 and G5 (except brushed) |           |
| ZAAPRFTC#...   | RIFT hook in COLOURED brass  | Tubes Colours* cat. C0, C1, C2, C3                          |           |
| ZAMRFT4824#LNN<br>ZAMRFT6024#LNN<br>ZAMRFT4815#LNN<br>ZAMRFT6015#LNN | Wooden storage shelf for RIFT 24 dim. 48x15 cm<br>Wooden storage shelf for RIFT 24 dim. 60x15 cm<br>Wooden storage shelf for RIFT 15 dim. 48x15 cm<br>Wooden storage shelf for RIFT 15 dim. 60x15 cm | Natural Wood  |           |
| ZAMRFT4824#LBC<br>ZAMRFT6024#LBC<br>ZAMRFT4815#LBC<br>ZAMRFT6015#LBC | Wooden storage shelf for RIFT 24 dim. 48x15 cm<br>Wooden storage shelf for RIFT 24 dim. 60x15 cm<br>Wooden storage shelf for RIFT 15 dim. 48x15 cm<br>Wooden storage shelf for RIFT 15 dim. 60x15 cm | Matt White  |           |

\* the GRGR Chrome Grey finish is NOT available

**ELECTRIC CONTROLS**

Electric control is via the use of the ZRF007 thermostat which regulates the room temperature by interacting with up to a maximum of 5 radiators.

| Code   | Description  | Finishes | Price (€) |
|--------|--|----------|-----------|
| ZRF007 | Radio frequency Room Thermostat Kit with weekly programmer for wall mounting, wireless and certified ECodesign. The Kit includes the wall box radio frequency receiver which must strictly be installed. | White    |           |

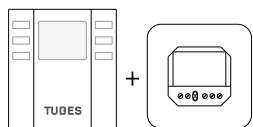

cod. ZRF007

# DOUBLE ALIGNED VERTICAL RIFT 2.24 - ELECTRIC VERSION

ALUMINIUM electric DESIGN radiator



EL

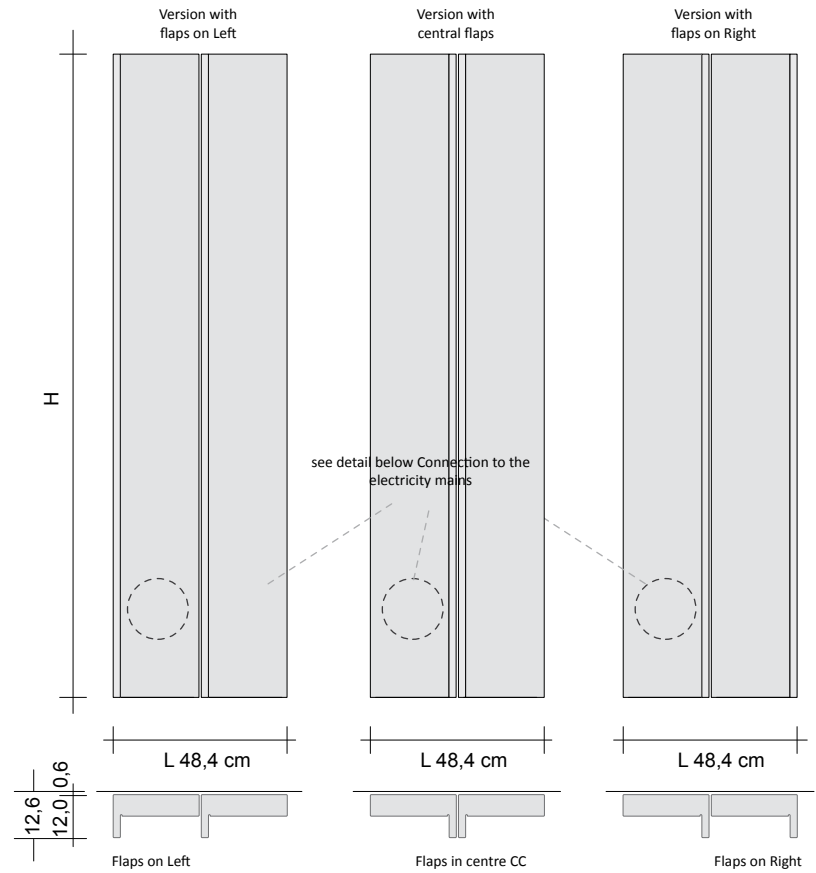

## CONNECTION DIAGRAM

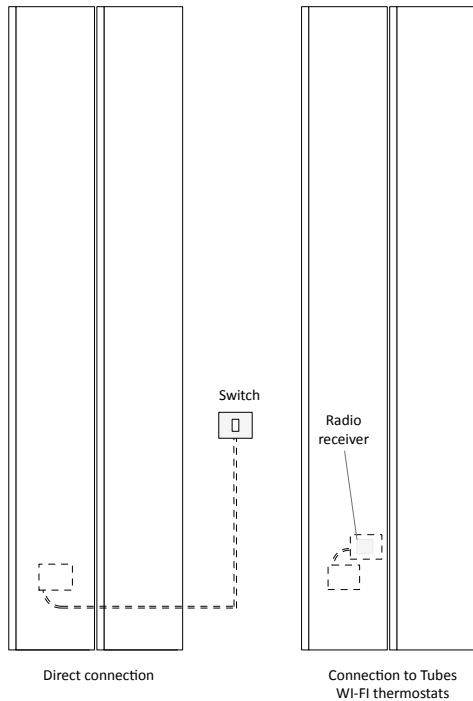

### Electric Control

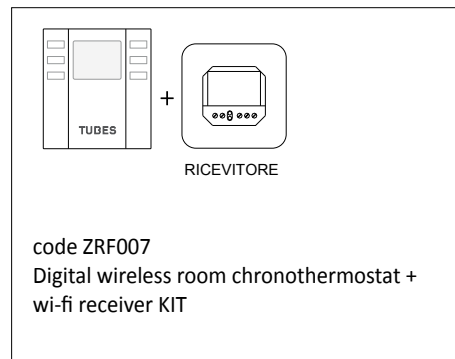

### Connection cable to the electricity mains

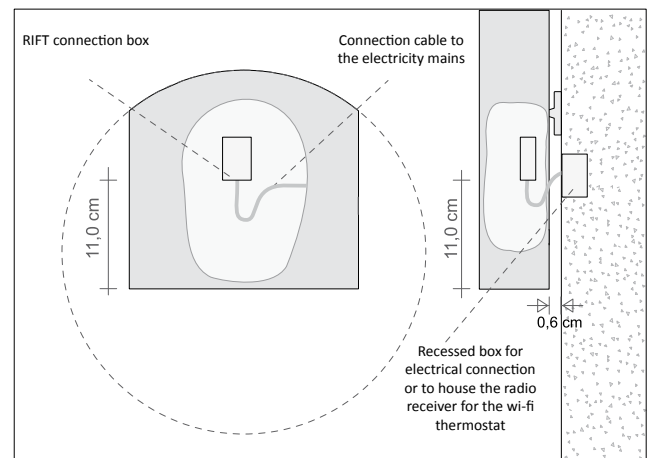

Product code **RFTV24DE#DX180901011**

RFTV24DE#DX180 Article code specified in the price table  
 9010 Colour/finish code specified in the Official TUBES COLOUR CHART  
 Rh Flap



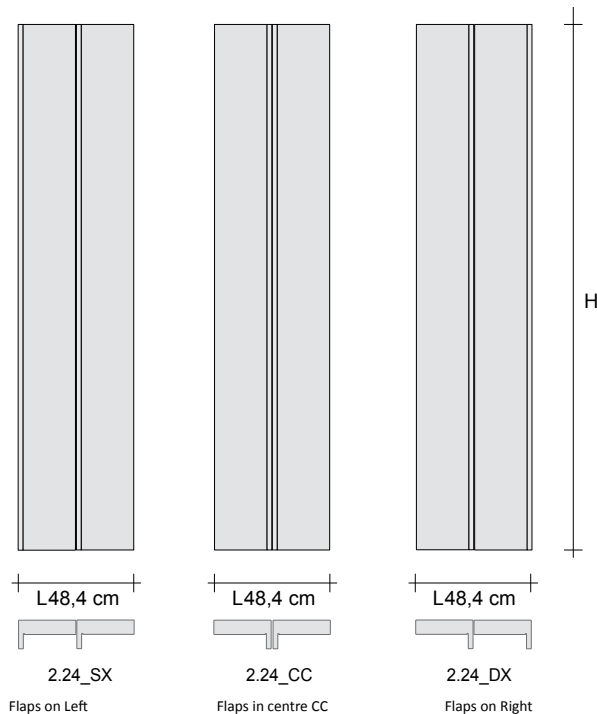

**ADDITIONAL COLOUR CHARGES**

Finishes and Anodizing see page. 5 or the colour table provided at the end of this price list.

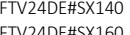
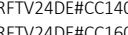
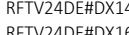
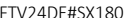

Heights available  
 H. = 140 cm  
 H. = 160 cm  
 H. = 180 cm

**Double Left, Centre and Right Aligned Electric 24**

| Model  | H (cm) | L (cm) | Electrical Resistance (Watts) | Price Standard White Cat. C0 (€) | Price Category C1/C2 (€) | Price Category C3 (€) | Price Multi_Color (2) (€) |
|--|--------|--------|-------------------------------|----------------------------------|--------------------------|-----------------------|---------------------------|
|  RFTV24DE#SX140 | 140,0  | 48,4   | 700 W                         |                                  |                          |                       |                           |
|  RFTV24DE#CC140 | 140,0  | 48,4   | 1000 W                        |                                  |                          |                       |                           |
|  RFTV24DE#DX140 | 140,0  | 48,4   | 1120 W                        |                                  |                          |                       |                           |
|  RFTV24DE#SX160 | 160,0  | 48,4   |                               |                                  |                          |                       |                           |
|  RFTV24DE#CC160 | 160,0  | 48,4   |                               |                                  |                          |                       |                           |
|  RFTV24DE#DX160 | 160,0  | 48,4   |                               |                                  |                          |                       |                           |
|  RFTV24DE#SX180 | 180,0  | 48,4   |                               |                                  |                          |                       |                           |
|  RFTV24DE#CC180 | 180,0  | 48,4   |                               |                                  |                          |                       |                           |
|  RFTV24DE#DX180 | 180,0  | 48,4   |                               |                                  |                          |                       |                           |

Colour GRRC Chrome Grey NOT available for the RIFT model.

(1) In the MULTICOLOR version the code is V24DEM; in this case, the different colors must be specified.

**RIFT accessories**



Hook code ZAAPRFT#...



Towel rail code ZAPSRFT#...

| Code      | Description                  | Finishes  | Price (€) |
|-----------|------------------------------|---|-----------|
| ZAAPRFT#  | RIFT hook in PLATED brass    | Galvanic finish cat. G0, G1, G2, G3 and G5 (except brushed) |           |
| ZAPSRFT#  | Towel Rail in PLATED brass   |   |           |
| ZAAPRFTC# | RIFT hook in COLOURED brass  | Tubes Colours* cat. C0, C1, C2, C3                          |           |
| ZAPSRFTC# | Towel Rail in COLOURED brass |   |           |

\* the GRRC Chrome Grey finish is NOT available

**ELECTRIC CONTROLS**

Electric control is via the use of the ZRF007 thermostat which regulates the room temperature by interacting with up to a maximum of 5 radiators.

| Code   | Description  | Finishes | Price (€) |
|--------|--|----------|-----------|
| ZRF007 | Radio frequency Room Thermostat Kit with weekly programmer for wall mounting, wireless and certified ECodesign. The Kit includes the wall box radio frequency receiver which must strictly be installed. | White    |           |

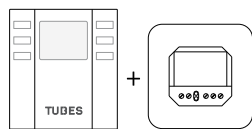

cod. ZRF007

# DOUBLE OFFSET VERTICAL RIFT 15.24 - ELECTRIC VERSION

ALUMINIUM electric DESIGN radiator



EL

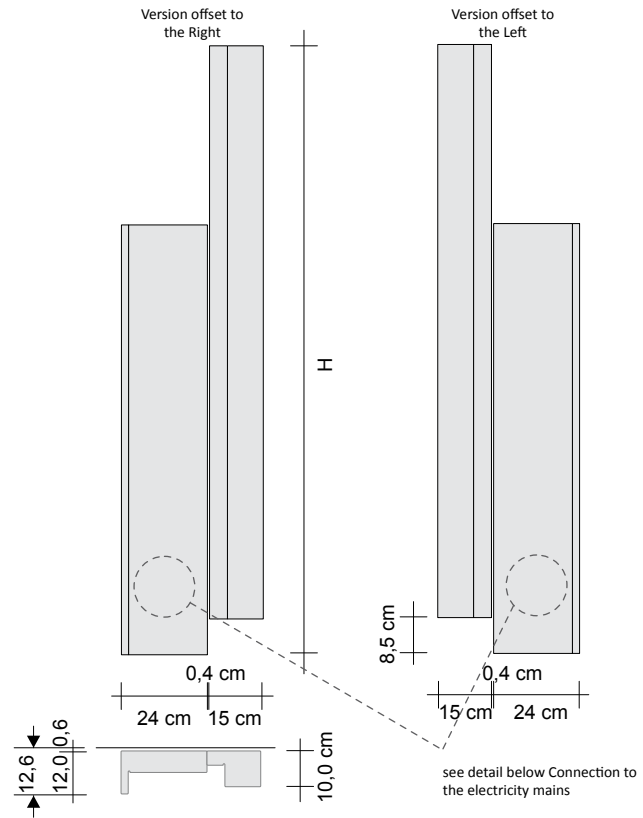

## CONNECTION DIAGRAM

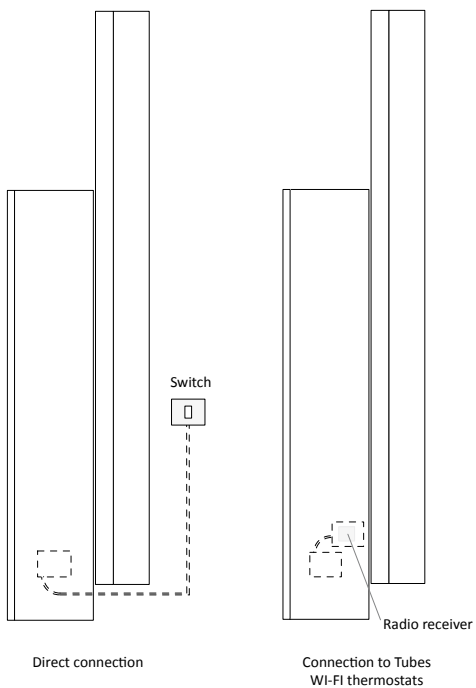

## Electric Control

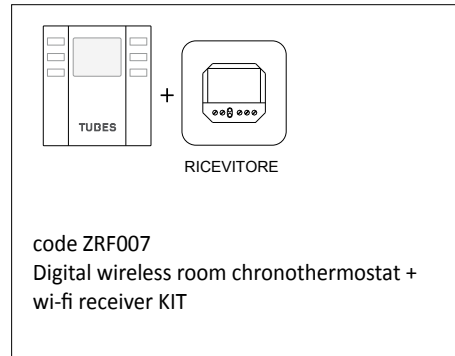

## Connection cable to the electricity mains

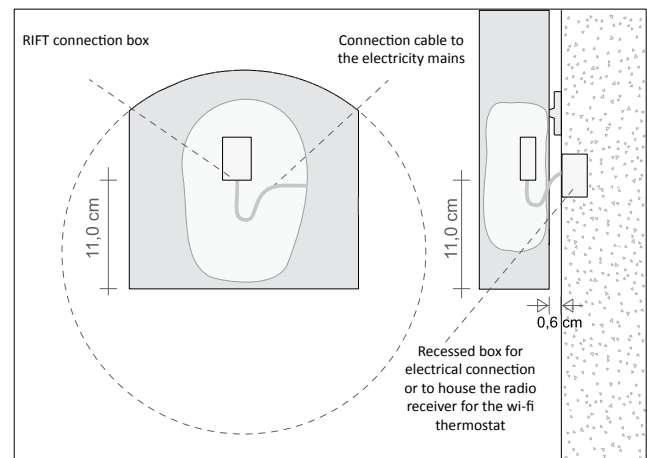

Product code **RFTVDDE2#DX120160901007**

RFTVDDE2#DX120160 Article code specified in the price table

9010

Colour/finish code specified in the Official TUBES COLOUR CHART

Rh

Flap

**ADDITIONAL COLOUR CHARGES**

Finishes and Anodizing see page. 5 or the colour table provided at the end of this price list.

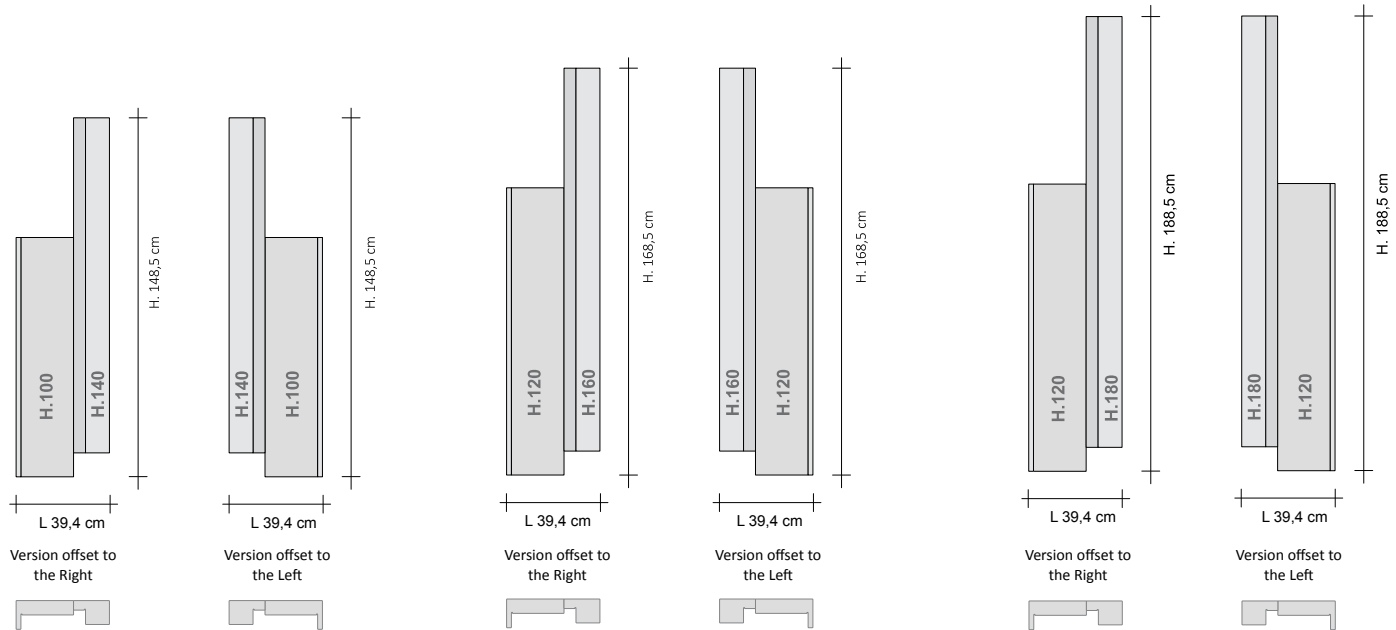

**Double Left and Right Offset Vertical Electric**

| Model             | H (cm) | L (cm) | Electrical Resistance (Watts) | Price Standard White Cat. C0 (€) | Price Category C1/C2 (€) | Price Category Cat. C3 (€) | Price Multi_Color (2) (€) |
|-------------------|--------|--------|-------------------------------|----------------------------------|--------------------------|----------------------------|---------------------------|
| RFTVDDE2#SX140100 | 148,5  | 39,4   | 490 W                         |                                  |                          |                            |                           |
| RFTVDDE2#SX160120 | 168,5  | 39,4   | 630 W                         |                                  |                          |                            |                           |
| RFTVDDE2#SX180120 | 188,5  | 39,4   | 780 W                         |                                  |                          |                            |                           |

Colour GRRC Chrome Grey NOT available for the RIFT model.

(1) In the MULTICOLOR version the code is VDDE2M; in this case, the different colors must be specified.



Hook code ZAAPRFT#...



Towel rail code ZAPSRFT#...

**RIFT accessories**

| Code                   | Description   | Finishes  | Price (€) |
|------------------------|---|---|-----------|
| ZAAPRFT#<br>ZAPSRFT#   | RIFT hook in PLATED brass<br>Towel Rail in PLATED brass     | Galvanic finish cat. G0, G1, G2, G3 and G5 (except brushed) |           |
| ZAAPRFTC#<br>ZAPSRFTC# | RIFT hook in COLOURED brass<br>Towel Rail in COLOURED brass | Tubes Colours* cat. C0, C1, C2, C3                          |           |

\* the GRRC Chrome Grey finish is NOT available

**ELECTRIC CONTROLS**

Electric control is via the use of the ZRF007 thermostat which regulates the room temperature by interacting with up to a maximum of 5 radiators.

| Code   | Description  | Finishes | Price (€) |
|--------|--|----------|-----------|
| ZRF007 | Radio frequency Room Thermostat Kit with weekly programmer for wall mounting, wireless and certified ECodesign. The Kit includes the wall box radio frequency receiver which must strictly be installed. | White    |           |

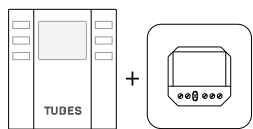

cod. ZRF007



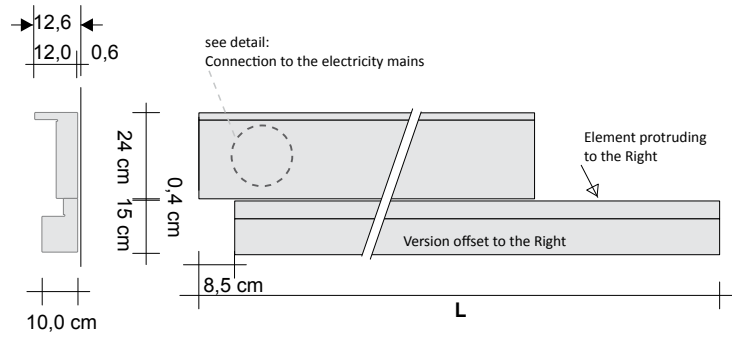
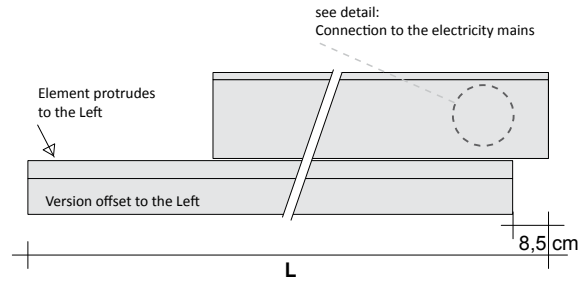

## CONNECTION DIAGRAM

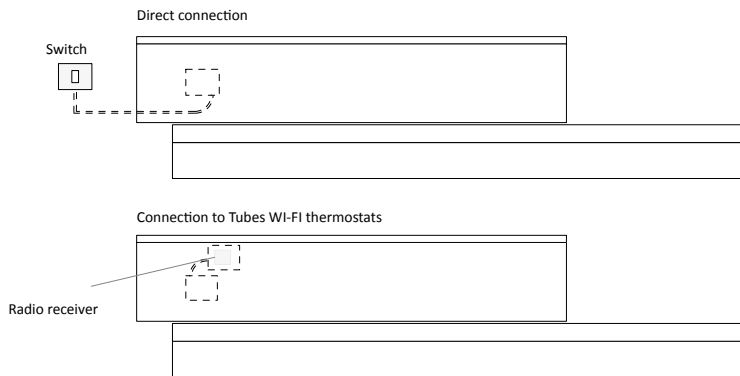

## Electric Control

code ZRF007  
Digital wireless room chronothermostat +  
wi-fi receiver KIT

## Connection cable to the electricity mains

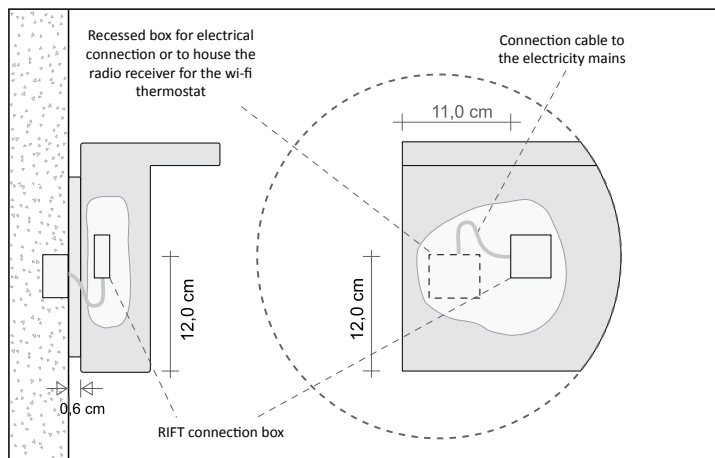

Product code **RFTODDE2#DX120160901007**

RFTODDE2#DX120160 Article code specified in the price table  
 9010 Colour/finish code specified in the Official TUBES COLOUR CHART  
 Rh Offset

**ADDITIONAL COLOUR CHARGES**

Finishes and Anodizing see page. 5 or the colour table provided at the end of this price list.

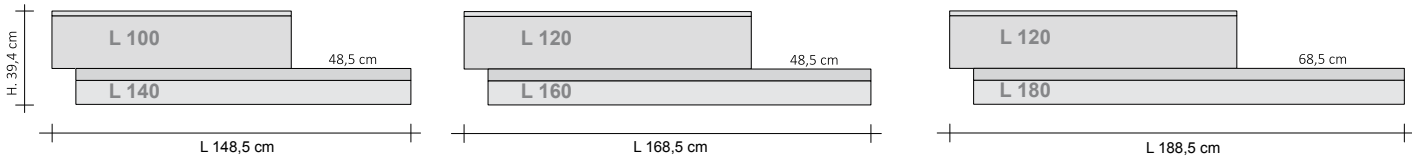

**Version offset to the Right**

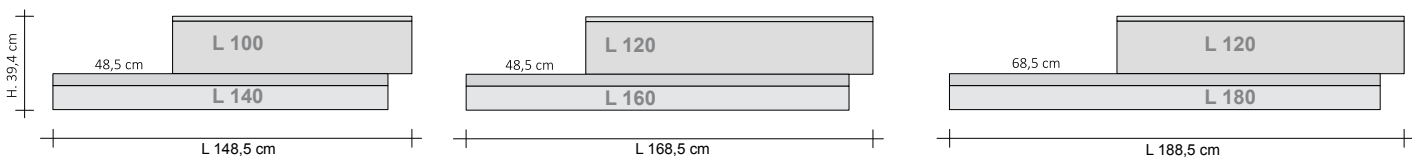

**Offset Version on left**

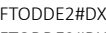
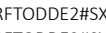
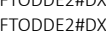
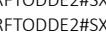

**Left and Right Offset Horizontal - Electric**

| Model   | H (cm) | L (cm) | Electrical Resistance (Watts) | Price Standard White Cat. C0 (€) | Price Category C1/C2 (€) | Price Category Cat. C3 (€) | Price Multi_Color (2) (€) |
|---|--------|--------|-------------------------------|----------------------------------|--------------------------|----------------------------|---------------------------|
|  RFTODDE2#DX100140 | 39,4   | 148,5  | 490 W                         |                                  |                          |                            |                           |
|  RFTODDE2#SX100140 | 39,4   | 148,5  | 490 W                         |                                  |                          |                            |                           |
|  RFTODDE2#DX120160 | 39,4   | 168,5  | 630 W                         |                                  |                          |                            |                           |
|  RFTODDE2#SX120160 | 39,4   | 168,5  | 630 W                         |                                  |                          |                            |                           |
|  RFTODDE2#DX120180 | 39,4   | 188,5  | 780 W                         |                                  |                          |                            |                           |
|  RFTODDE2#SX120180 | 39,4   | 188,5  | 780 W                         |                                  |                          |                            |                           |

Colour GR CR Chrome Grey NOT available for the RIFT model.

(1) In the MULTICOLOR version the code is ODDE2M; in this case, the different colors must be specified.

**RIFT accessories**



Hook code ZAAPRFT#...



RIFT shelf  
 L 48 cm cod. ZAMRFT48#...  
 L 60 cm cod. ZAMRFT60#...

| Code   | Description  | Finishes  | Price (€) |
|--|--|---|-----------|
| ZAAPRFT#...  | RIFT hook in PLATED brass  | Galvanic finish cat. G0, G1, G2, G3 and G5 (except brushed) |           |
| ZAAPRFTC#...   | RIFT hook in COLOURED brass  | Tubes Colours* cat. C0, C1, C2, C3                          |           |
| ZAMRFT4824#LNN<br>ZAMRFT6024#LNN<br>ZAMRFT4815#LNN<br>ZAMRFT6015#LNN | Wooden storage shelf for RIFT 24 dim. 48x15 cm<br>Wooden storage shelf for RIFT 24 dim. 60x15 cm<br>Wooden storage shelf for RIFT 15 dim. 48x15 cm<br>Wooden storage shelf for RIFT 15 dim. 60x15 cm | Natural Wood Finish   |           |
| ZAMRFT4824#LBC<br>ZAMRFT6024#LBC<br>ZAMRFT4815#LBC<br>ZAMRFT6015#LBC | Wooden storage shelf for RIFT 24 dim. 48x15 cm<br>Wooden storage shelf for RIFT 24 dim. 60x15 cm<br>Wooden storage shelf for RIFT 15 dim. 48x15 cm<br>Wooden storage shelf for RIFT 15 dim. 60x15 cm | Matt White Finish   |           |

\* the GR CR Chrome Grey finish is NOT available

**ELECTRIC CONTROLS**

Electric control is via the use of the ZRF007 thermostat which regulates the room temperature by interacting with up to a maximum of 5 radiators.

| Code   | Description  | Finishes | Price (€) |
|--------|--|----------|-----------|
| ZRF007 | Radio frequency Room Thermostat Kit with weekly programmer for wall mounting, wireless and certified ECOdesign. The Kit includes the wall box radio frequency receiver which must strictly be installed. | White    |           |

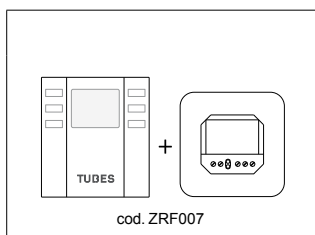

# MULTIPLE OFFSET VERTICAL RIFT 15 - ELECTRIC VERSION

ALUMINIUM electric DESIGN radiator



EL

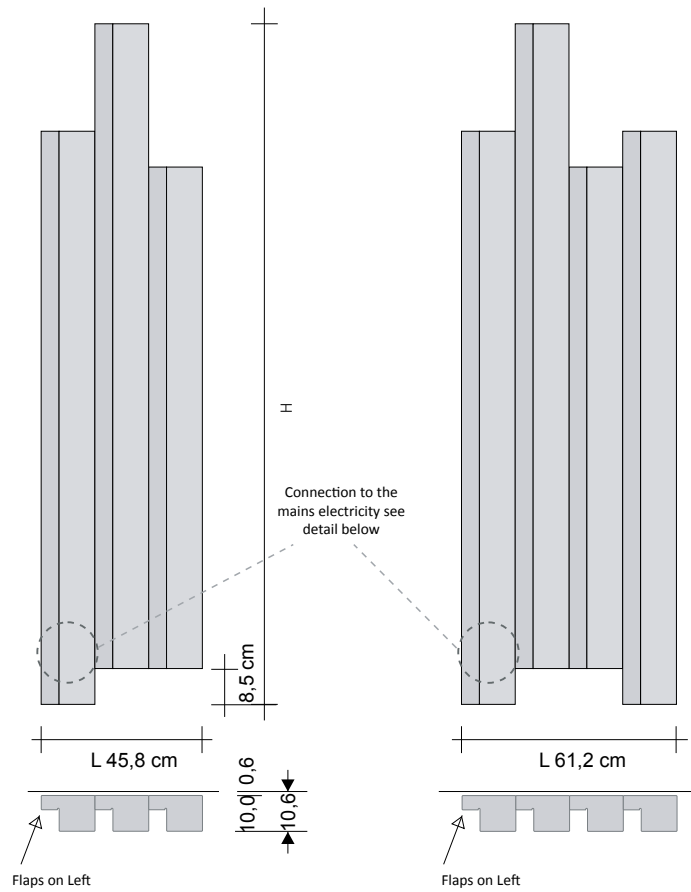

## CONNECTION DIAGRAM

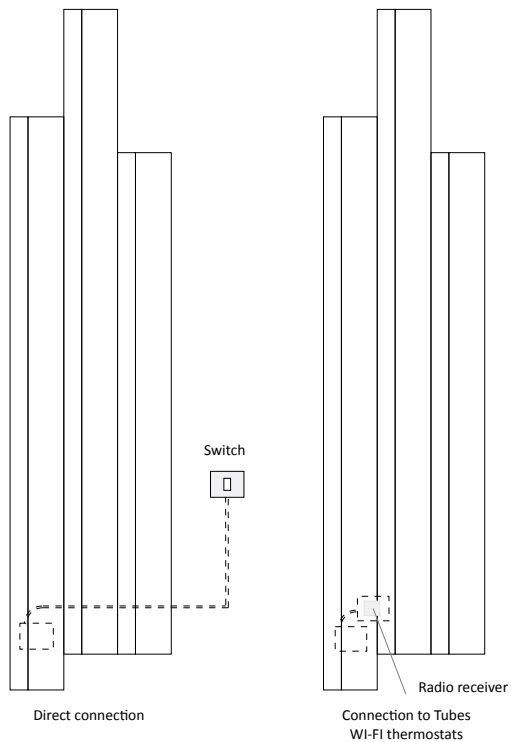

## RIFT connection box

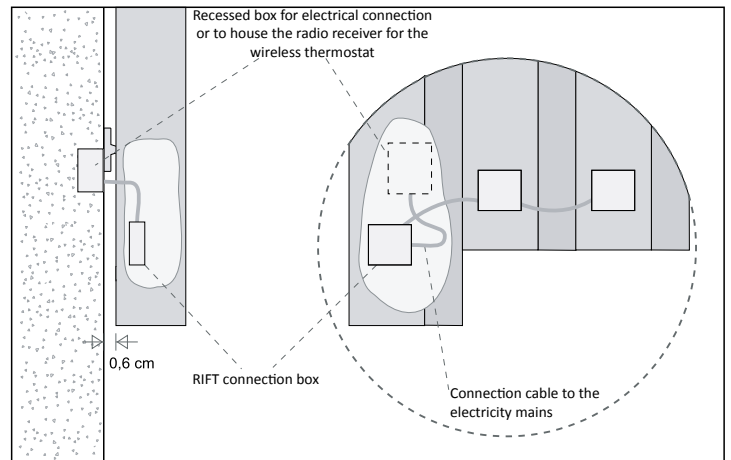

Product code **RFTV15MDE3#SX1909010**

RFTV15MDE3#SX190 Article code specified in the price table  
 9010 Colour/finish code specified in the Official TUBES COLOUR CHART  
 LEFT Flap

**ADDITIONAL COLOUR CHARGES**

Finishes and Anodizing see page. 5 or the colour table provided at the end of this price list.

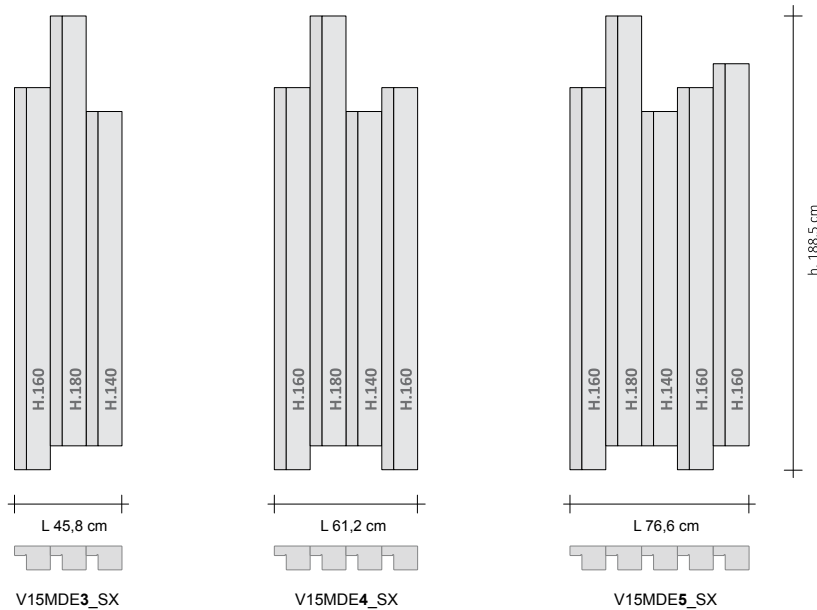

**Multiple Offset Vertical 15 - Hydraulic version RIGHT-LEFT**

| Model            | H (cm) | L (cm) | Electrical Resistance (Watts) | Price Standard White Cat. C0 (€) | Price Category C1/C2 (€) | Price Category Cat. C3 (€) | Price Multi_Color (2) (€) |
|------------------|--------|--------|-------------------------------|----------------------------------|--------------------------|----------------------------|---------------------------|
| RFTV15MDE3#DX190 | 188,5  | 45,8   | 1100 W                        |                                  |                          |                            |                           |
| RFTV15MDE3#SX190 | 188,5  | 45,8   | 1100 W                        |                                  |                          |                            |                           |
| RFTV15MDE4#DX190 | 188,5  | 61,2   | 1450 W                        |                                  |                          |                            |                           |
| RFTV15MDE4#SX190 | 188,5  | 61,2   | 1450 W                        |                                  |                          |                            |                           |
| RFTV15MDE5#DX190 | 188,5  | 76,6   | 1800 W                        |                                  |                          |                            |                           |
| RFTV15MDE5#SX190 | 188,5  | 76,6   | 1800 W                        |                                  |                          |                            |                           |

Colour GRRC Chrome Grey NOT available for the RIFT model.

(1) In the MULTICOLOR version the code is RFTV15MDE3M/ RFTV15MDE4M/ RFTV15MDE5M and the different colours must be specified

**ELECTRIC CONTROLS**

Electric control is via the use of the ZRF007 thermostat which regulates the room temperature by interacting with up to a maximum of 5 radiators.

| Code   | Description  | Finishes | Price (€) |
|--------|--|----------|-----------|
| ZRF007 | Radio frequency Room Thermostat Kit with weekly programmer for wall mounting, wireless and certified ECOdesign. The Kit includes the wall box radio frequency receiver which must strictly be installed. | White    |           |

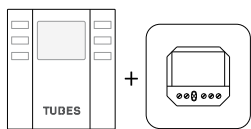

cod. ZRF007

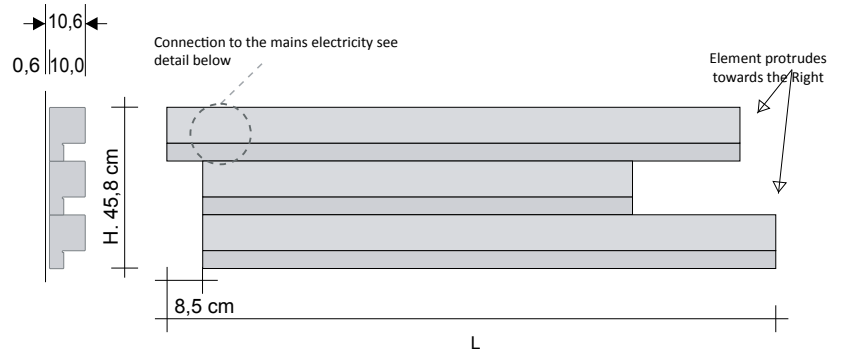

**CONNECTION DIAGRAM**

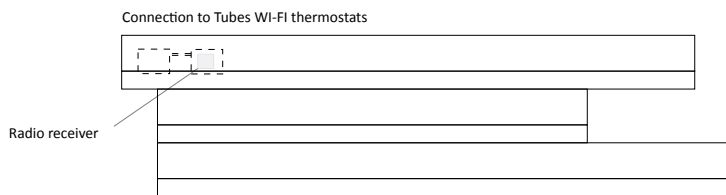
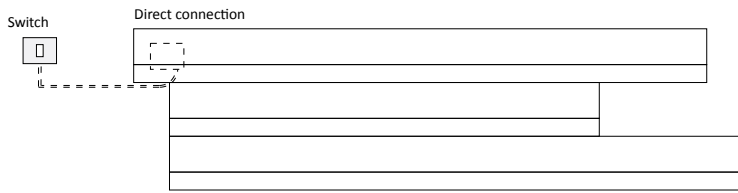

**Connection cable to the electricity mains**

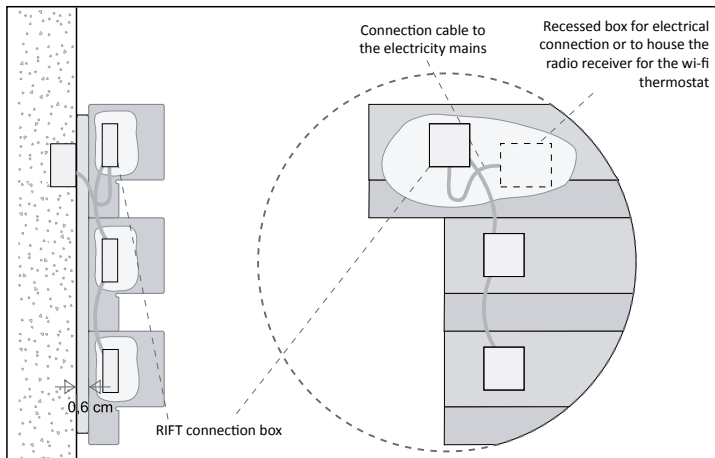

Product code **RFTO15MDE3#SX1909010**

RFTO15MDE3#SX190 Article code specified in the price table  
 9010 Colour/finish code specified in the Official TUBES COLOUR CHART  
 LEFT Flap

**ADDITIONAL COLOUR CHARGES**

Finishes and Anodizing see page. 5 or the colour table provided at the end of this price list.

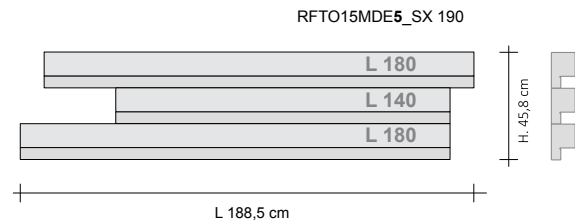
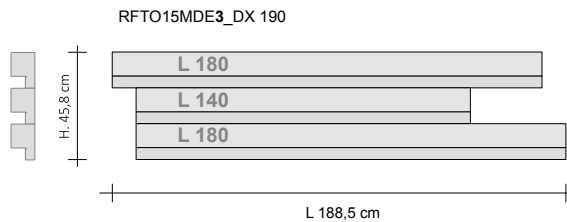
**MULTIPLE Horizontal - Electric version Left and Right**

| Model  | H<br>(cm) | L<br>(cm) | Electrical<br>Resistance<br>(Watts) | Price<br>Standard White<br>Cat. C0 (€) | Price<br>Category<br>C1/C2 (€) | Price<br>Category<br>Cat. C3 (€) | Price<br>Multi_Color<br>(2) (€) |
|--|-----------|-----------|-------------------------------------|--|--------------------------------|----------------------------------|---------------------------------|
|  RFTO15MDE3#DX190 | 45,8      | 188,5     | 1100 w                              |  |                                |                                  |                                 |
|  RFTO15MDE3#SX190 |           |           |                                     |  |                                |                                  |                                 |

Colour GRRC Chrome Grey NOT available for the RIFT model.

(1) In the MULTICOLOR version the code is RFTO15MDE3M and the different colours must be specified

**RIFT accessories**

RIFT shelf

| Code                             | Description  | Finishes     | Price (€) |
|----------------------------------|--|--------------|-----------|
| ZAMRFT4815#LNN<br>ZAMRFT6015#LNN | Wooden storage shelf for RIFT 15 dim. 48x15 cm<br>Wooden storage shelf for RIFT 15 dim. 60x15 cm | Natural Wood |           |
| ZAMRFT4815#LBC<br>ZAMRFT6015#LBC | Wooden storage shelf for RIFT 15 dim. 48x15 cm<br>Wooden storage shelf for RIFT 15 dim. 60x15 cm | Matt White   |           |

**ELECTRIC CONTROLS**

Electric control is via the use of the ZRF007 thermostat which regulates the room temperature by interacting with up to a maximum of 5 radiators.

| Code   | Description  | Finishes | Price (€) |
|--------|--|----------|-----------|
| ZRF007 | Radio frequency Room Thermostat Kit with weekly programmer for wall mounting, wireless and certified ECOdesign. The Kit includes the wall box radio frequency receiver which must strictly be installed. | White    |           |

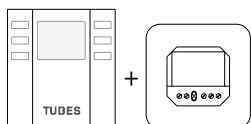

cod. ZRF007

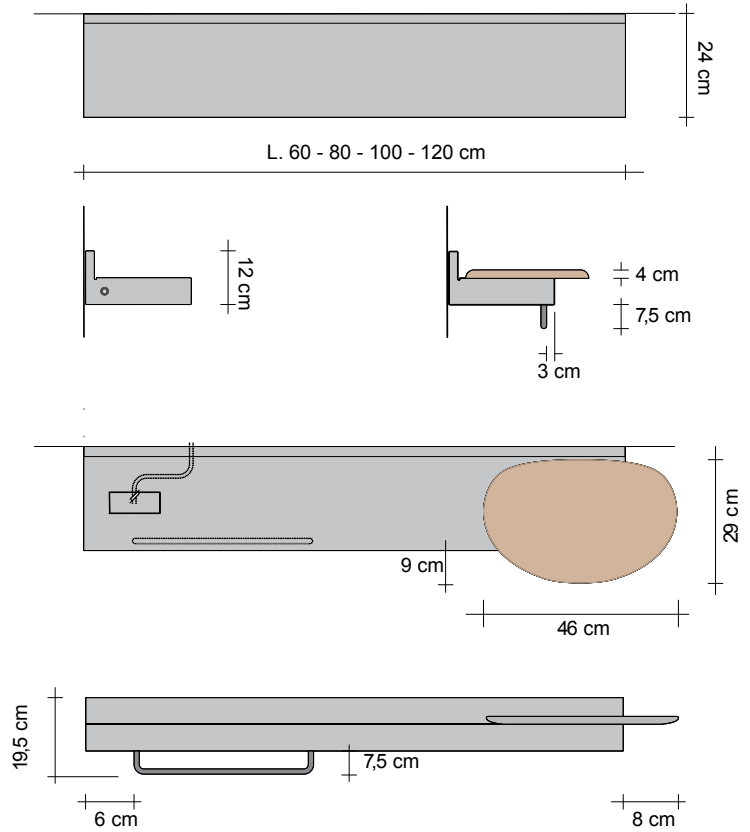

**CONNECTION DIAGRAM**

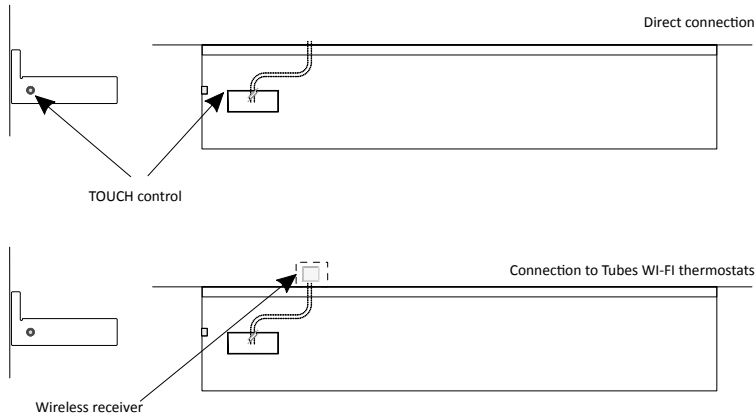

**Connection to the electricity mains**

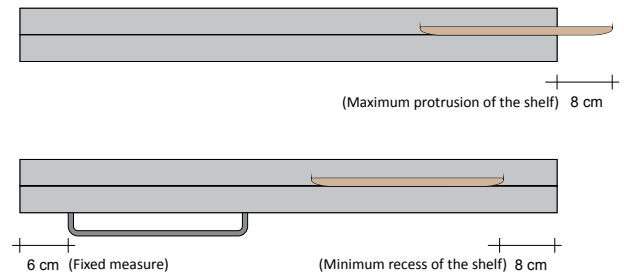
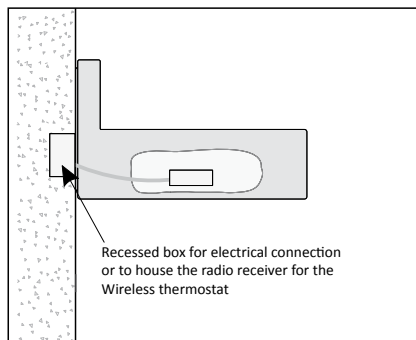

Product code **RFTREL#0609010**

RFTREL#060 Article code specified in the price table  
9010 Colour/finish code specified in the Official TUBES COLOUR CHART

**ADDITIONAL COLOUR CHARGES**

Finishes and Anodizing see page. 5 or the colour table provided at the end of this price list.

**RIFT/reverse electric**

| Model  | H<br>(cm) | L<br>(cm) | Electrical<br>Resistance<br>(Watts) | Price<br>Standard White<br>Cat. C0 (€) | Price<br>Category<br>C1/C2 (€) | Price<br>Category<br>Cat. C3 (€) |
|--|-----------|-----------|-------------------------------------|--|--------------------------------|----------------------------------|
| RIFT / reverse version with control and adjustment via TOUCH switch                                    |           |           |                                     |  |                                |                                  |
| RFTREL#060   | 12,0      | 60,0      | 150 W                               |  |                                |                                  |
| RFTREL#080   | 12,0      | 80,0      | 150 W                               |  |                                |                                  |
| RFTREL#100   | 12,0      | 100,0     | 300 W                               |  |                                |                                  |
| RFTREL#120   | 12,0      | 120,0     | 300 W                               |  |                                |                                  |
| Version with control via TOUCH switch, adjustment and programming via wireless digital thermostat code |           |           |                                     |  |                                |                                  |
| ZRF007   |           |           |                                     |  |                                |                                  |
| RFTREW#060   | 12,0      | 60,0      | 150 W                               |  |                                |                                  |
| RFTREW#080   | 12,0      | 80,0      | 150 W                               |  |                                |                                  |
| RFTREW#100   | 12,0      | 100,0     | 300 W                               |  |                                |                                  |
| RFTREW#120   | 12,0      | 120,0     | 300 W                               |  |                                |                                  |

**RIFT accessories**

The RIFT/Reverse heated towel rail must UNDER ALL CIRCUMSTANCES be ordered together with the radiator since it must be set up during production; the heated towel rail CANNOT be installed at a later date.



RIFT/reverse towel rail



RIFT/ reverse wooden shelf

| Code             | Description   | Finishes  | Price (€) |
|------------------|---|---|-----------|
| ZAPSRFTRG#050... | RIFT/reverse towel rail* L.50.0xH.7.5 cm  | Galvanic finish cat. G0, G1, G2, G3 and G5 (except brushed) |           |
| ZAPSRFTRG#065... | RIFT/reverse towel rail* L.65.0xH.7.5 cm (available only for Rift L.80, 100, 120 cm)  |   |           |
| ZAPSRFTRG#095... | Towel rail* RIFT/reverse L.95,0xH.7,5 cm (available only for Rift L.120 cm)   |   |           |
| ZAPSRFTR#050     | RIFT/reverse towel rail* L.50.0xH.7.5 cm  | Tubes Colours** cat. C0, C1, C2, C3                         |           |
| ZAPSRFTR#065     | RIFT/reverse towel rail* L.65.0xH.7.5 cm (available only for Rift L.80, 100, 120 cm)  |   |           |
| ZAPSRFTR#095     | Towel rail* RIFT/reverse L.95,0xH.7,5 cm (available only for Rift L.80, 100, 120 cm)  |   |           |
| ZAMRFTREV        | Wooden shelf for RIFT/reverse L.46.0x29.0 cm (Installable in width L.100/120 and only on the Right side of the RIFT/reverse using a magnetic attachment to be secured inside the shelf. | Natural Wood  |           |

\* The RIFT/reverse towel rail must be set up specifically, so it must be ordered together with the radiator.

\*\* the GRGR Chrome Grey finish is NOT available

**ELECTRIC CONTROLS**

cod. ZRF007  
ECOdesign digital wireless room  
chronothermostat + receiver kit

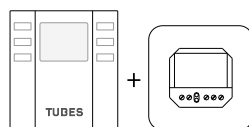

cod. ZRF007

ZRF007 electric control is included in the price of the RFTREW version



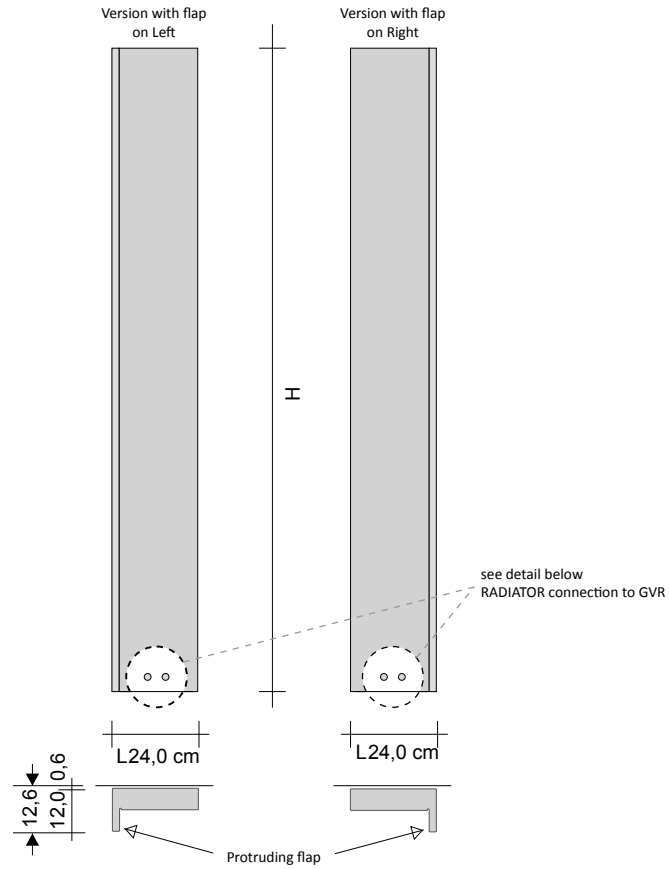

**RADIATOR connection to GVR**

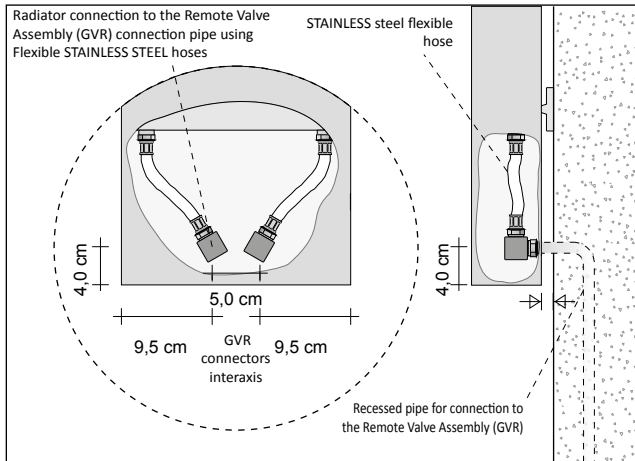

**Connection to the Remote Valve Assembly (GVR)**

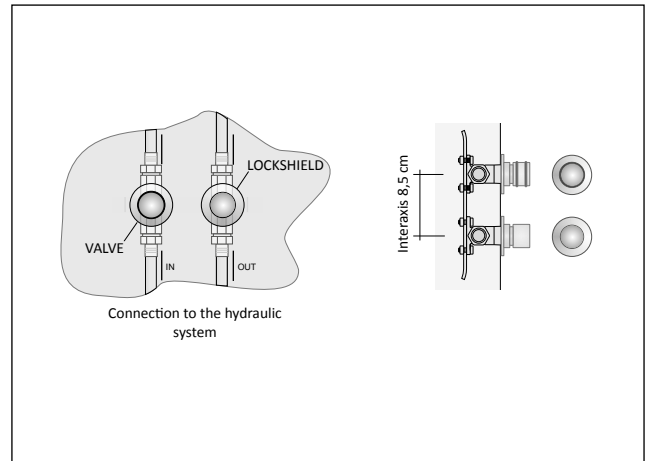

Product code **RFTV24SI#SX1409010R12**





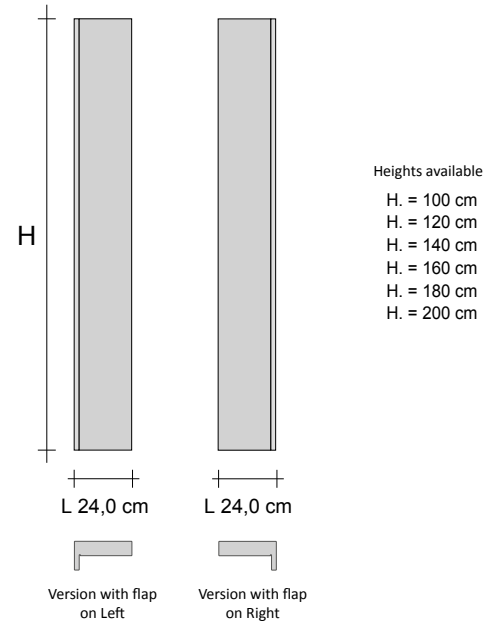

RFTV24SI#SX140 Article code specified in the price table  
 9010 Colour/finish code specified in the Official TUBES COLOUR CHART  
 R12 Connector code  
 LEFT Flap

**ADDITIONAL COLOUR CHARGES**

Finishes and Anodizing see page. 5 or the colour table provided at the end of this price list.



**Vertical Single - Hydraulic version RIGHT-LEFT**

| Model  | H (cm) | L (cm) | Heat output in Watts COLOURED version |          | Price Standard White Cat. C0 (€) | Price Category C1/C2 (€) | Price Category C3 (€) |
|--|--------|--------|---------------------------------------|----------|----------------------------------|--------------------------|-----------------------|
|  |        |        | ΔT. 50°C                              | ΔT. 30°C |                                  |                          |                       |
|  RFTV24SI#SX100  | 100,0  | 24,0   | 330                                   | 172      |                                  |                          |                       |
|  RFTV24SI#SX120  | 120,0  | 24,0   | 396                                   | 207      |                                  |                          |                       |
|  RFTV24SI#SX140 | 140,0  | 24,0   | 462                                   | 241      |                                  |                          |                       |
|  RFTV24SI#SX160 | 160,0  | 24,0   | 528                                   | 276      |                                  |                          |                       |
|  RFTV24SI#SX180 | 180,0  | 24,0   | 594                                   | 310      |                                  |                          |                       |
|  RFTV24SI#SX200 | 200,0  | 24,0   | 660                                   | 345      |                                  |                          |                       |

For RAL colours not included in the chart 30 % on the price of White C0 - request feasibility in advance.  
 (1) GRCC Chrome Grey colour NOT available for the RIFT model

**RIFT accessories**



Hook code ZAAPRFT#...



Towel rail code ZAPSRFT#...

| Code         | Description                  | Finishes  | Price (€) |
|--------------|------------------------------|---|-----------|
| ZAAPRFT#...  | RIFT hook in PLATED brass    | Galvanic finish cat. G0, G1, G2, G3 and G5 (except brushed) |           |
| ZAPSRFT#...  | Towel Rail in PLATED brass   |   |           |
| ZAAPRFTC#... | RIFT hook in COLOURED brass  | Tubes Colours* cat. C0, C1, C2, C3                          |           |
| ZAPSRFTC#... | Towel Rail in COLOURED brass |   |           |

**Remote valve assembly – GVR**

For more information on the choice of valves, see p. 312

| Code       | Description   | Finishes          | Price (€) |
|------------|---|-------------------|-----------|
| GVR#1      | RECESSED Valve that can be fitted with a thermostat and Lockshield assembly for REMOTE connection | Chromed Plated    |           |
| GVRTG#1... | RECESSED thermostatic valve and Lockshield assembly for REMOTE connection*                        |                   |           |
| GVRC#1...  | RECESSED Valve that can be fitted with a thermostat and Lockshield assembly for REMOTE connection | Coloured Coloured |           |
| GVRTC#1... | RECESSED thermostatic valve and Lockshield assembly for REMOTE connection*                        |                   |           |

Plated finishes: See table of Tubes special finishes  
 Colored Finishes: see categories C0, C1, C2 and C3 of the Tubes color chart  
 \* The price does not include the cost of the thermostatic head (see page 320)

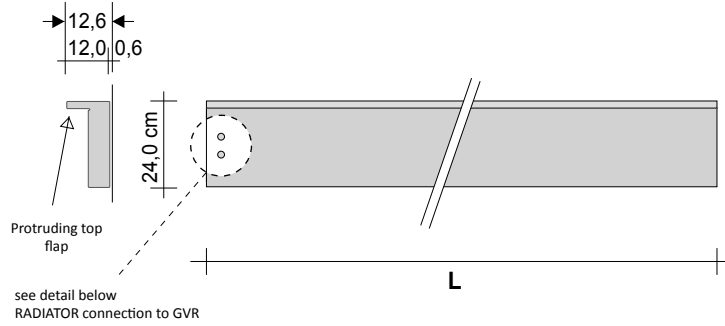

**RADIATOR connection to GVR**

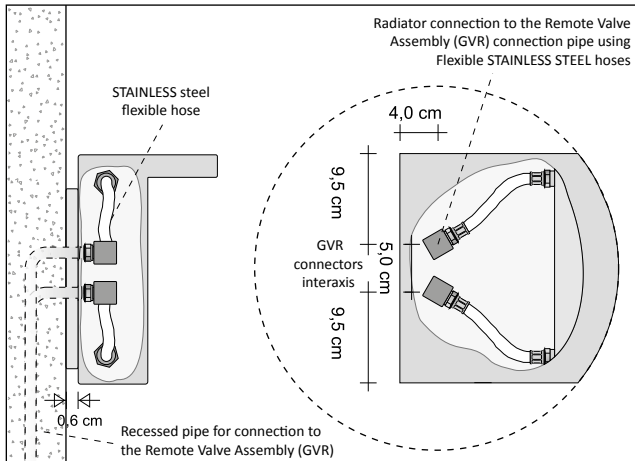

**Connection to the Remote Valve Assembly (GVR)**

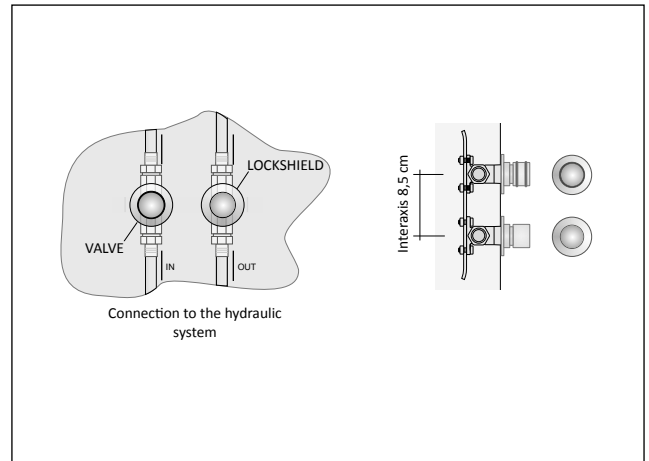

Product code **RFTO24SI#SU1409010R12**

RFTO24SI#SU140 Article code specified in the price table  
 9010 Colour/finish code specified in the Official TUBES COLOUR CHART  
 R12 Connector code

**ADDITIONAL COLOUR CHARGES**

Finishes and Anodizing see page. 5 or the colour table provided at the end of this price list.

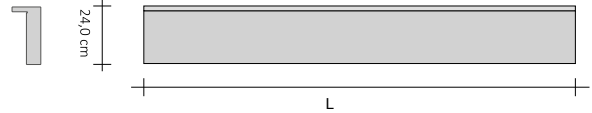

Widths available

- L. = 100 cm
- L. = 120 cm
- L. = 140 cm
- L. = 160 cm
- L. = 180 cm
- L. = 200 cm

**Single Horizontal Top Flap - Hydraulic**

| Model          | H<br>(cm) | L<br>(cm) | Heat output in Watts<br>COLOURED version |          | Price<br>Standard White<br>Cat. C0 (€) | Price<br>Category<br>C1/C2 (€) | Price<br>Category<br>Cat. C3 (€) |
|----------------|-----------|-----------|--|----------|--|--------------------------------|----------------------------------|
|                |           |           | ΔT. 50°C                                 | ΔT. 30°C |  |                                |                                  |
| RFTO24SI#SU100 | 24,0      | 100,0     | 279                                      | 150      |  |                                |                                  |
| RFTO24SI#SU120 | 24,0      | 120,0     | 335                                      | 181      |  |                                |                                  |
| RFTO24SI#SU140 | 24,0      | 140,0     | 391                                      | 211      |  |                                |                                  |
| RFTO24SI#SU160 | 24,0      | 160,0     | 447                                      | 241      |  |                                |                                  |
| RFTO24SI#SU180 | 24,0      | 180,0     | 503                                      | 271      |  |                                |                                  |
| RFTO24SI#SU200 | 24,0      | 200,0     | 559                                      | 301      |  |                                |                                  |

For RAL colours not included in the chart 30 % on the price of White C0 - request feasibility in advance.  
 (1) GRRC Chrome Grey colour NOT available for the RIFT model

**RIFT accessories**



Hook code ZAAPRFT#...



RIFT shelf  
 L 48 cm cod. ZAMRFT48#...  
 L 60 cm cod. ZAMRFT60#...

| Code                             | Description  | Finishes  | Price (€) |
|----------------------------------|--|---|-----------|
| ZAAPRFT#...                      | RIFT hook in PLATED brass  | Galvanic finish cat. G0, G1, G2, G3 and G5 (except brushed) |           |
| ZAAPRFTC#...                     | RIFT hook in COLOURED brass  | Tubes Colours* cat. C0, C1, C2, C3                          |           |
| ZAMRFT4824#LNN<br>ZAMRFT6024#LNN | Wooden storage shelf for RIFT 24 dim. 48x15 cm<br>Wooden storage shelf for RIFT 24 dim. 60x15 cm | Natural Wood Finish   |           |
| ZAMRFT4824#LBC<br>ZAMRFT6024#LBC | Wooden storage shelf for RIFT 24 dim. 48x15 cm<br>Wooden storage shelf for RIFT 24 dim. 60x15 cm | Matt White Finish   |           |

**Remote valve assembly – GVR**

For more information on the choice of valves, see p. 312

| Code   | Description   | Finishes             | Price (€) |
|--|---|----------------------|-----------|
| GVR#1<br>GVRTG#1...  | RECESSED Valve that can be fitted with a thermostat and Lockshield assembly for REMOTE connection<br>RECESSED thermostatic valve and Lockshield assembly for REMOTE connection* | Chromed<br>Plated    |           |
| GVRC#1...<br>GVRTC#1...  | RECESSED Valve that can be fitted with a thermostat and Lockshield assembly for REMOTE connection<br>RECESSED thermostatic valve and Lockshield assembly for REMOTE connection* | Coloured<br>Coloured |           |
| Plated finishes: See table of Tubes special finishes<br>Colored Finishes: see categories C0, C1, C2 and C3 of the Tubes color chart<br>* The price does not include the cost of the thermostatic head (see page 320) |   |                      |           |

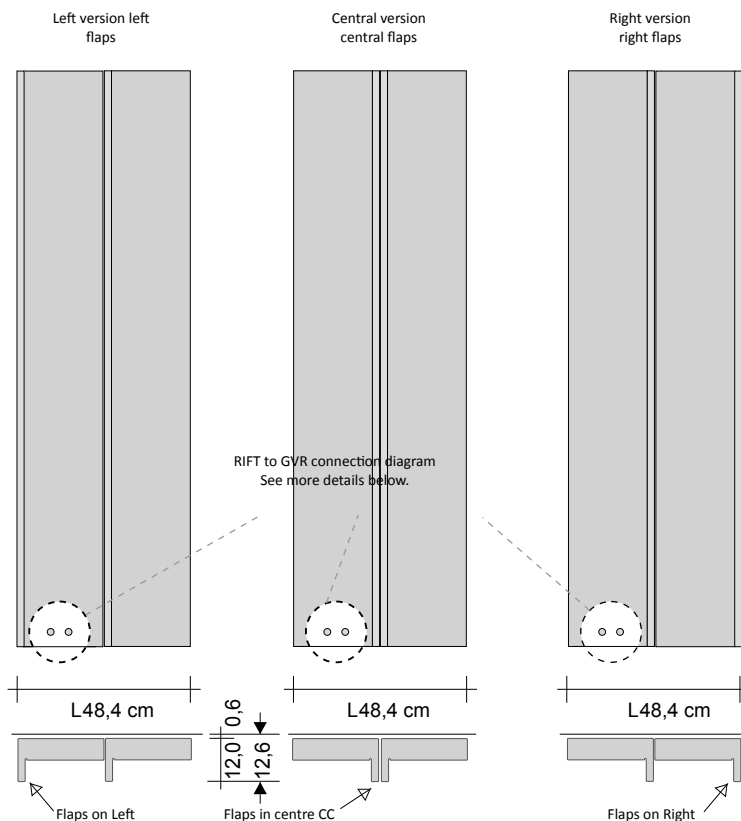

### RADIATOR connection to GVR

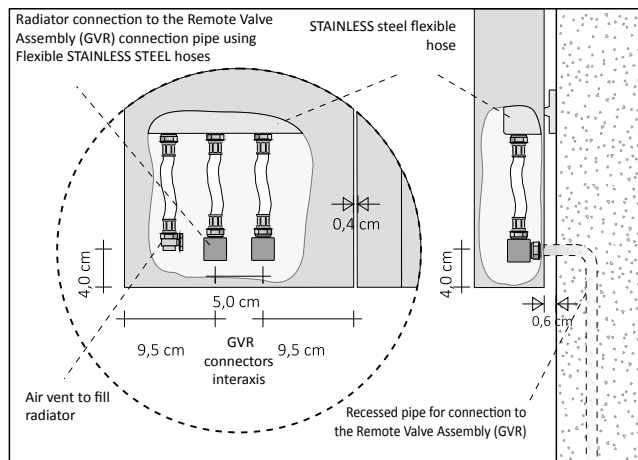

### Connection to the Remote Valve Assembly (GVR)

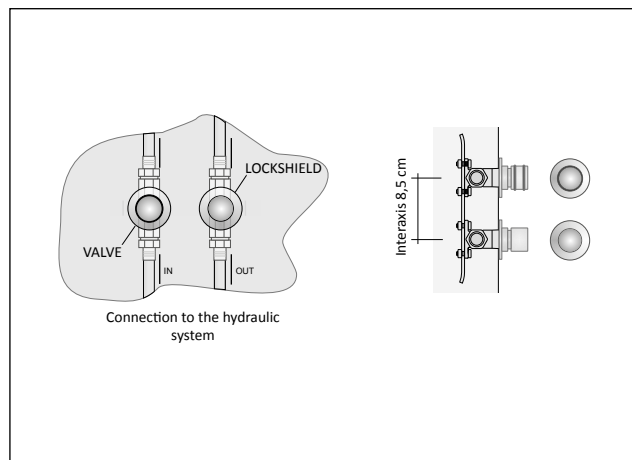

### RIFT accessories



Hook code ZAAPRFT#...



Towel rail code ZAPSRFT#...

| Code                         | Description   | Finishes  | Price (€) |
|------------------------------|---|---|-----------|
| ZAAPRFT#...<br>ZAPSRFT#...   | RIFT hook in PLATED brass<br>Towel Rail in PLATED brass     | Galvanic finish cat. G0, G1, G2, G3 and G5 (except brushed) |           |
| ZAAPRFTC#...<br>ZAPSRFTC#... | RIFT hook in COLOURED brass<br>Towel Rail in COLOURED brass | Tubes Colours* cat. C0, C1, C2, C3                          |           |

Product code **RFTV24DAI2#SX160ST9010R12**

RFTV24DAI2#SX160 Article code specified in the price table  
 9010 Colour/finish code specified in the Official TUBES COLOUR CHART  
 R12 Connector code  
 LEFT Flap on Left

**ADDITIONAL COLOUR CHARGES**

Finishes and Anodizing see page. 5 or the colour table provided at the end of this price list.

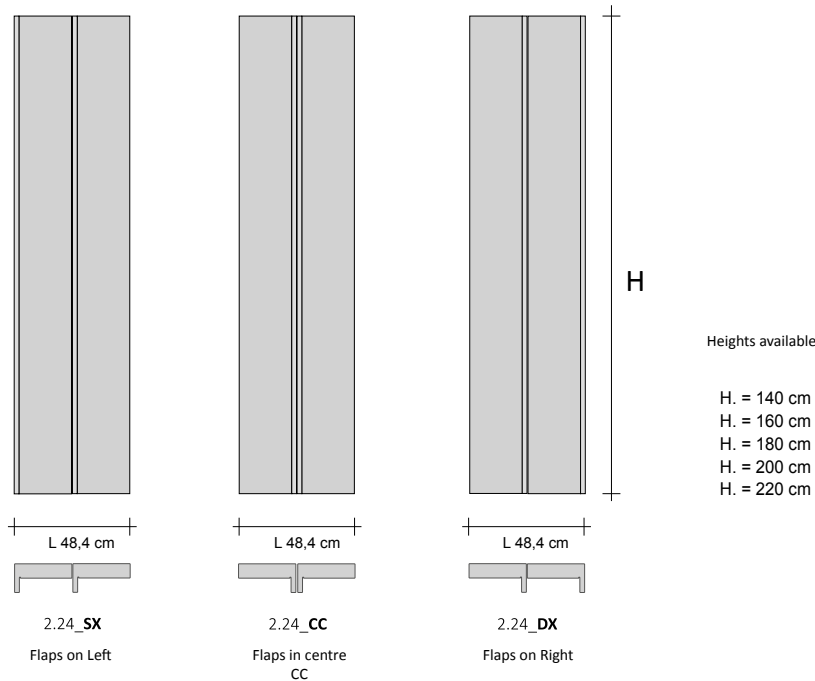

**Double Aligned Vertical 24 - Hydraulic version RIGHT-LEFT-CENTRED**

| Model            | H (cm) | L (cm) | Heat output in Watts COLOURED version |          | Price Standard White Cat. C0 (€) | Price Category C1/C2 (€) | Price <sup>(1)</sup> Multi_Colour Category Cat. C3 (€) |
|------------------|--------|--------|---------------------------------------|----------|----------------------------------|--------------------------|--|
|                  |        |        | ΔT. 50°C                              | ΔT. 30°C |                                  |                          |  |
| RFTV24DAI2#SX140 |        |        |                                       |          |                                  |                          |  |
| RFTV24DAI2#CC140 |        |        |                                       |          |                                  |                          |  |
| RFTV24DAI2#DX140 |        |        |                                       |          |                                  |                          |  |
| RFTV24DAI2#SX160 | 140,0  | 48,4   | 924                                   | 488      |                                  |                          |  |
| RFTV24DAI2#SX160 | 160,0  | 48,4   | 1056                                  | 558      |                                  |                          |  |
| RFTV24DAI2#SX180 | 180,0  | 48,4   | 1188                                  | 628      |                                  |                          |  |
| RFTV24DAI2#SX200 | 200,0  | 48,4   | 1320                                  | 697      |                                  |                          |  |
| RFTV24DAI2#SX220 | 220,0  | 48,4   | 1452                                  | 767      |                                  |                          |  |

(1) In the MULTI-COLOURED version, the code is RFTV24DAI2M and the various colours must be specified

**Remote valve assembly – GVR**

For more information on the choice of valves, see p. 312

| Code       | Description   | Finishes          | Price (€) |
|------------|---|-------------------|-----------|
| GVR#1      | RECESSED Valve that can be fitted with a thermostat and Lockshield assembly for REMOTE connection | Chromed Plated    |           |
| GVRTG#1... | RECESSED thermostatic valve and Lockshield assembly for REMOTE connection*                        |                   |           |
| GVRC#1...  | RECESSED Valve that can be fitted with a thermostat and Lockshield assembly for REMOTE connection | Coloured Coloured |           |
| GVRTC#1... | RECESSED thermostatic valve and Lockshield assembly for REMOTE connection*                        |                   |           |

Plated finishes: See table of Tubes special finishes  
 Colored Finishes: see categories C0, C1, C2 and C3 of the Tubes color chart  
 \* The price does not include the cost of the thermostatic head (see page 320)

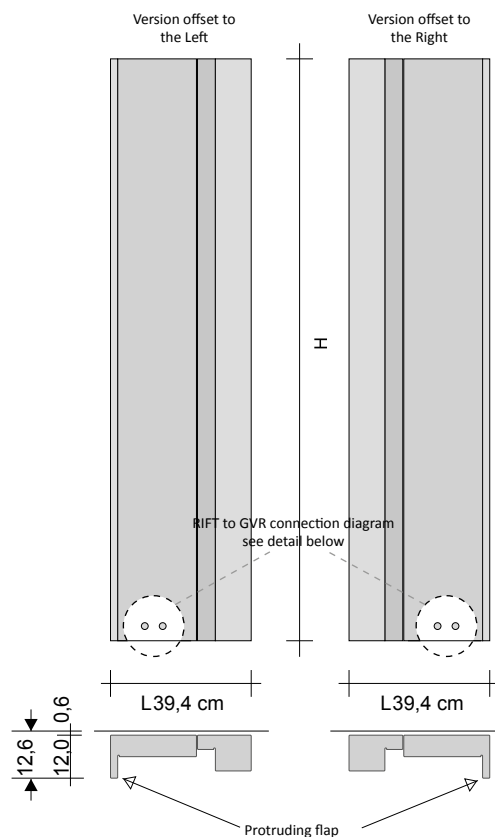

## RADIATOR connection to GVR

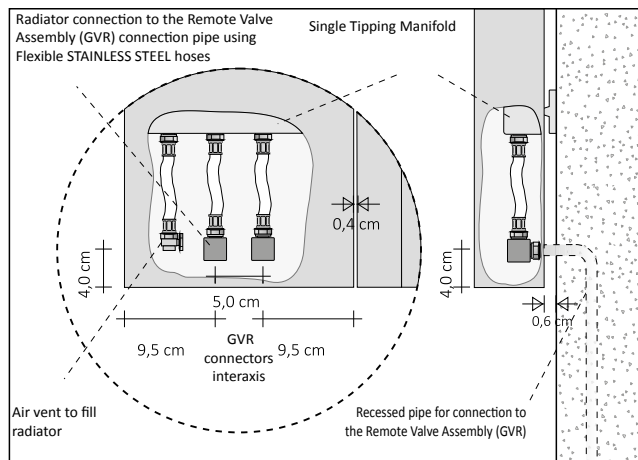

## Connection to the Remote Valve Assembly (GVR)

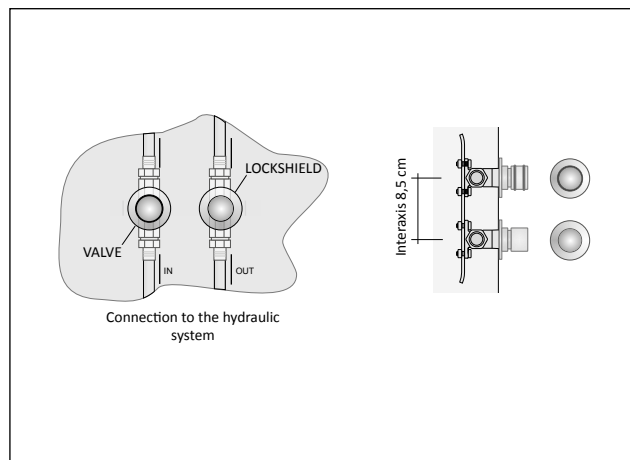

## RIFT accessories



Hook code ZAAPRFT#...



Towel rail code ZAPSRFT#...

| Code                         | Description   | Finishes  | Price (€) |
|------------------------------|---|---|-----------|
| ZAAPRFT#...<br>ZAPSRFT#...   | RIFT hook in PLATED brass<br>Towel Rail in PLATED brass     | Galvanic finish cat. G0, G1, G2, G3 and G5 (except brushed) |           |
| ZAAPRFTC#...<br>ZAPSRFTC#... | RIFT hook in COLOURED brass<br>Towel Rail in COLOURED brass | Tubes Colours* cat. C0, C1, C2, C3                          |           |

Product code **RFTVDAI2#SX1609010R12**



RFTVDAI2#SX160 Article code specified in the price table  
 9010 Colour/finish code specified in the Official TUBES COLOUR CHART  
 R12 Connector code  
 LEFT Flap on Left

**ADDITIONAL COLOUR CHARGES**

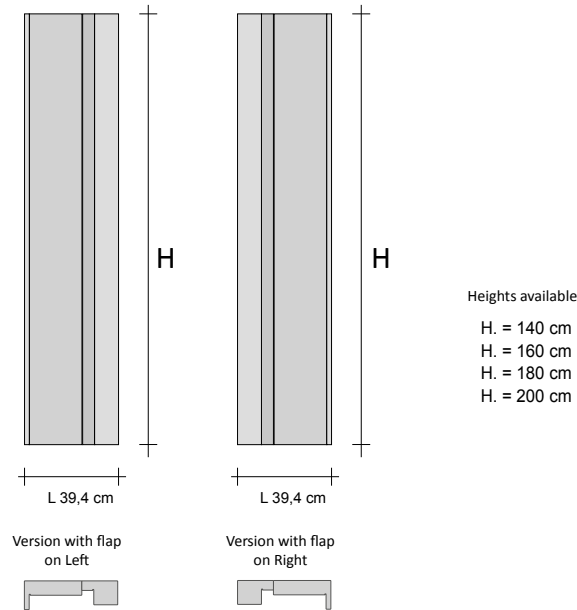
Finishes and Anodizing see page. 5 or the colour table provided at the end of this price list.



**Double Aligned Vertical - Hydraulic version RIGHT-LEFT**

| Model  | H (cm) | L (cm) | Heat output in Watts COLOURED version |          | Price Standard White Cat. C0 (€) | Price Category C1/C2 (€) | Price <sup>(1)</sup> Multi_Colour Category Cat. C3 (€) | Price (€) |
|--|--------|--------|---------------------------------------|----------|----------------------------------|--------------------------|--|-----------|
|  |        |        | ΔT. 50°C                              | ΔT. 30°C |                                  |                          |  |           |
|  RFTVDAI2#SX140 | 140,0  | 39,4   | 770                                   | 407      |                                  |                          |  |           |
|  RFTVDAI2#DX140 |        |        |                                       |          |                                  |                          |  |           |
| RFTVDAI2#SX160   | 160,0  | 39,4   | 881                                   | 465      |                                  |                          |  |           |
| RFTVDAI2#SX180   | 180,0  | 39,4   | 991                                   | 524      |                                  |                          |  |           |
| RFTVDAI2#SX200   | 200,0  | 39,4   | 1101                                  | 582      |                                  |                          |  |           |

(1) In the MULTI-COLOURED version, the code is RFTVDAI2M and the various colours must be specified

**Remote valve assembly – GVR**

For more information on the choice of valves, see p. 312

| Code   | Description   | Finishes          | Price (€) |
|--|---|-------------------|-----------|
|  |   |                   |           |
| GVR#1  | RECESSED Valve that can be fitted with a thermostat and Lockshield assembly for REMOTE connection | Chromed Plated    |           |
| GVRTG#1...   | RECESSED thermostatic valve and Lockshield assembly for REMOTE connection*                        |                   |           |
| GVRC#1...  | RECESSED Valve that can be fitted with a thermostat and Lockshield assembly for REMOTE connection | Coloured Coloured |           |
| GVRTC#1...   | RECESSED thermostatic valve and Lockshield assembly for REMOTE connection*                        |                   |           |
| Plated finishes: See table of Tubes special finishes<br>Colored Finishes: see categories C0, C1, C2 and C3 of the Tubes color chart<br>* The price does not include the cost of the thermostatic head (see page 320) |   |                   |           |



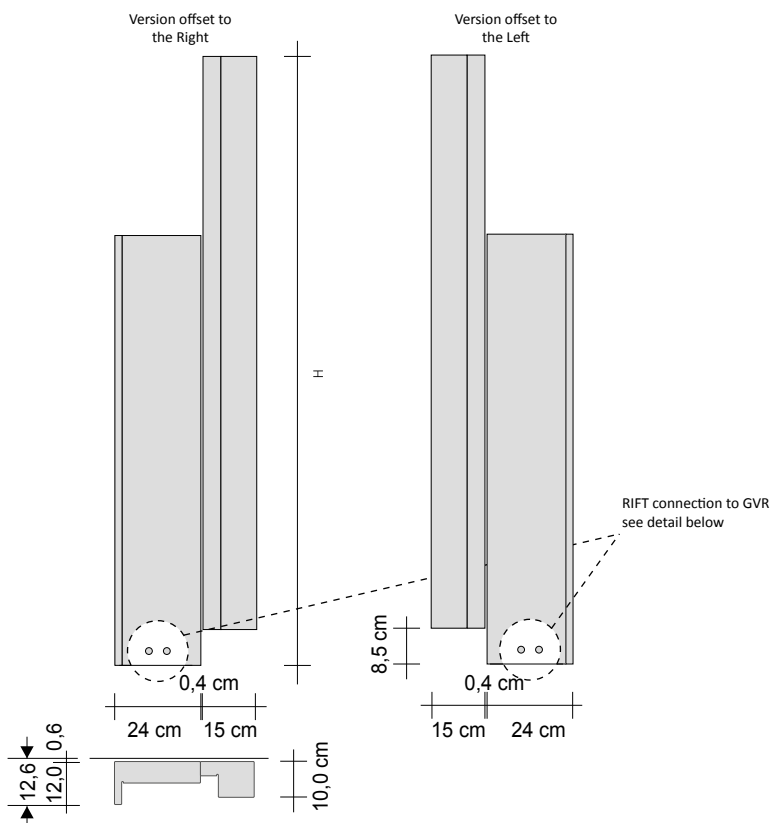

**RADIATOR connection to GVR**

**Connection to the Remote Valve Assembly (GVR)**

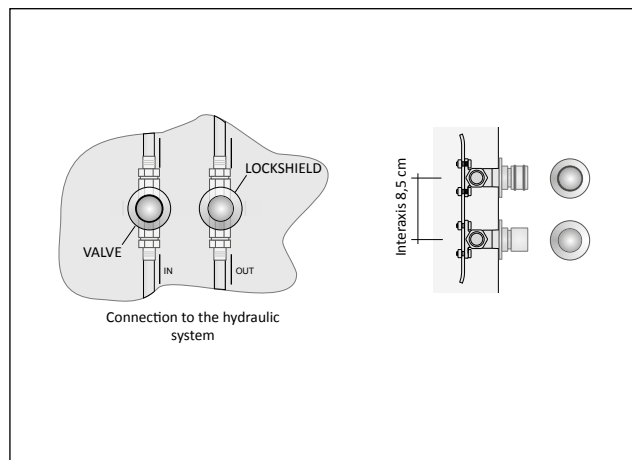
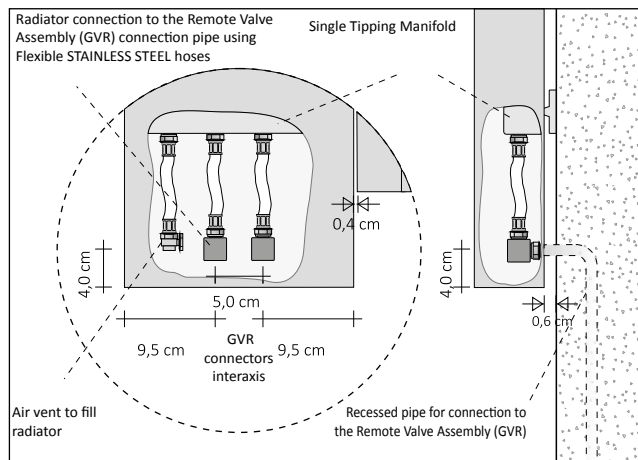

**RIFT accessories**



Hook code ZAAPRFT#...

Towel rail code ZAPSRFT#...

| Code                         | Description   | Finishes  | Price (€) |
|------------------------------|---|---|-----------|
| ZAAPRFT#...<br>ZAPSRFT#...   | RIFT hook in PLATED brass<br>Towel Rail in PLATED brass     | Galvanic finish cat. G0, G1, G2, G3 and G5 (except brushed) |           |
| ZAAPRFTC#...<br>ZAPSRFTC#... | RIFT hook in COLOURED brass<br>Towel Rail in COLOURED brass | Tubes Colours* cat. C0, C1, C2, C3                          |           |

Product code **RFTVDDI2#DX1201609010R12**

RFTVDDI2#DX120160 Article code specified in the price table  
 9010 Colour/finish code specified in the Official TUBES COLOUR CHART  
 R12 Connector code  
 Rh offset

**ADDITIONAL COLOUR CHARGES**

Finishes and Anodizing see page. 5 or the colour table provided at the end of this price list.

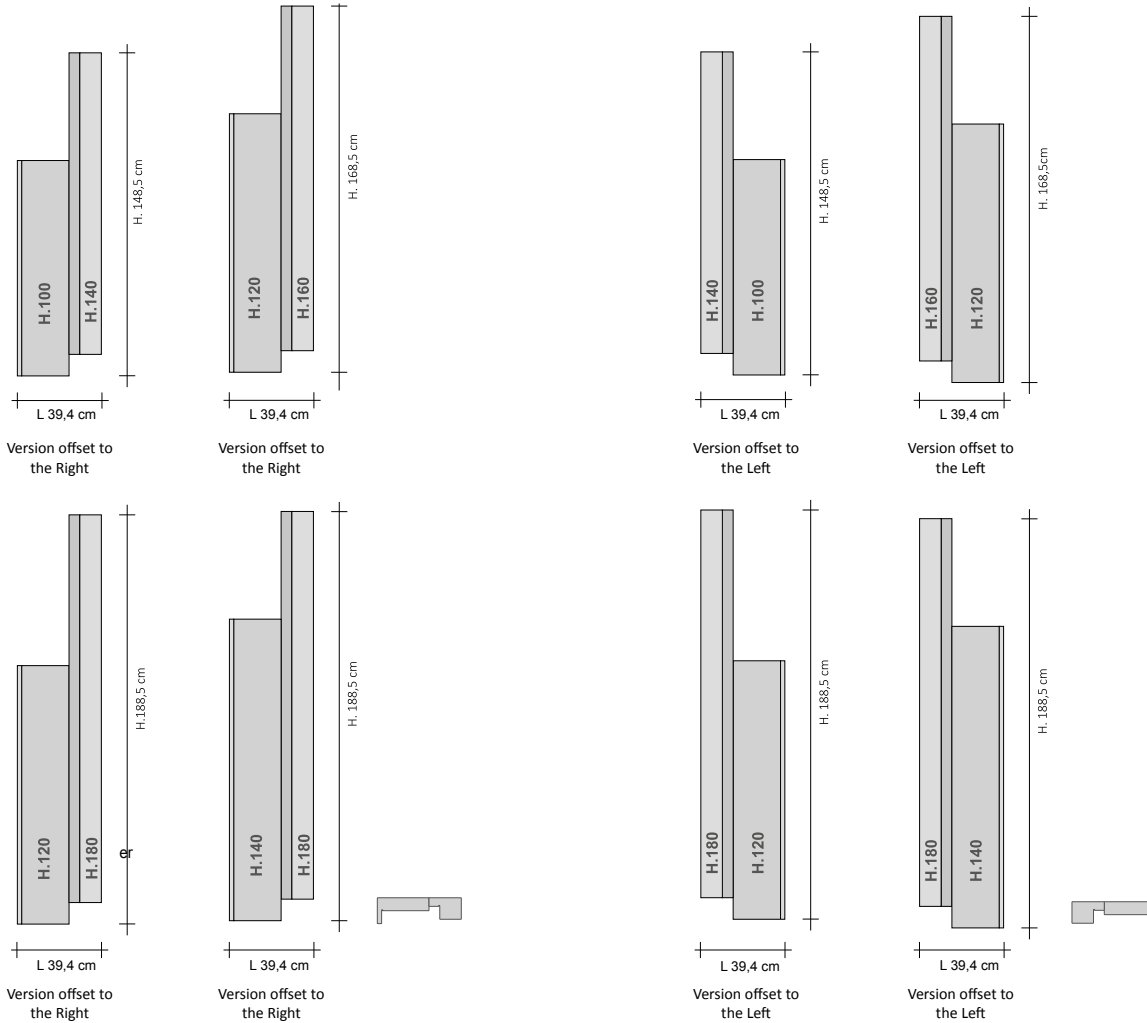

**Double Left and Right Offset Vertical Hydraulic**

| Model             | H (cm) | L (cm) | Heat output in Watts      |          | Price Standard White Cat. C0 (€) | Price Category C1/C2 (€) | Price <sup>(1)</sup> Multi_Colour Category Cat. C3 (€) |
|-------------------|--------|--------|---------------------------|----------|----------------------------------|--------------------------|--|
|                   |        |        | COLOURED version ΔT. 50°C | ΔT. 30°C |                                  |                          |  |
| RFTVDDI2#SX140100 | 148,5  | 39,4   | 700                       | 365      |                                  |                          |  |
| RFTVDDI2#DX100140 | 148,5  | 39,4   |                           |          |                                  |                          |  |
| RFTVDDI2#SX160120 | 168,5  | 39,4   | 821                       | 428      |                                  |                          |  |
| RFTVDDI2#DX120160 | 168,5  | 39,4   |                           |          |                                  |                          |  |
| RFTVDDI2#SX180120 | 188,5  | 39,4   | 870                       | 453      |                                  |                          |  |
| RFTVDDI2#DX120180 | 188,5  | 39,4   |                           |          |                                  |                          |  |
| RFTVDDI2#SX180140 | 188,5  | 39,4   | 942                       | 491      |                                  |                          |  |
| RFTVDDI2#DX140180 | 188,5  | 39,4   |                           |          |                                  |                          |  |

(1) In the MULTI-COLOUR version, the code is VDDI2M and the various colours must be specified

**Remote valve assembly – GVR**

For more information on the choice of valves, see p. 312

| Code   | Description   | Finishes          | Price (€) |
|--|---|-------------------|-----------|
| GVR#1  | RECESSED Valve that can be fitted with a thermostat and Lockshield assembly for REMOTE connection | Chromed Plated    |           |
| GVRTG#1...   | RECESSED thermostatic valve and Lockshield assembly for REMOTE connection*                        |                   |           |
| GVRC#1...  | RECESSED Valve that can be fitted with a thermostat and Lockshield assembly for REMOTE connection | Coloured Coloured |           |
| GVRTC#1...   | RECESSED thermostatic valve and Lockshield assembly for REMOTE connection*                        |                   |           |
| Plated finishes: See table of Tubes special finishes<br>Colored Finishes: see categories C0, C1, C2 and C3 of the Tubes color chart<br>* The price does not include the cost of the thermostatic head (see page 320) |   |                   |           |



# DOUBLE OFFSET HORIZONTAL RIFT 15.24 - HYDRAULIC VERSION

DESIGN radiator with hydraulic system in ALUMINUM

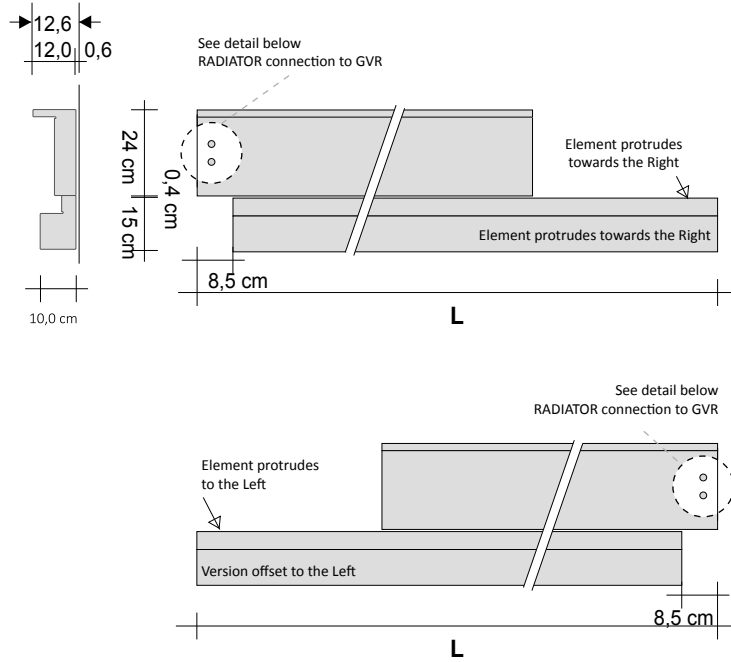

## RADIATOR connection to GVR

## Connection to the Remote Valve Assembly (GVR)

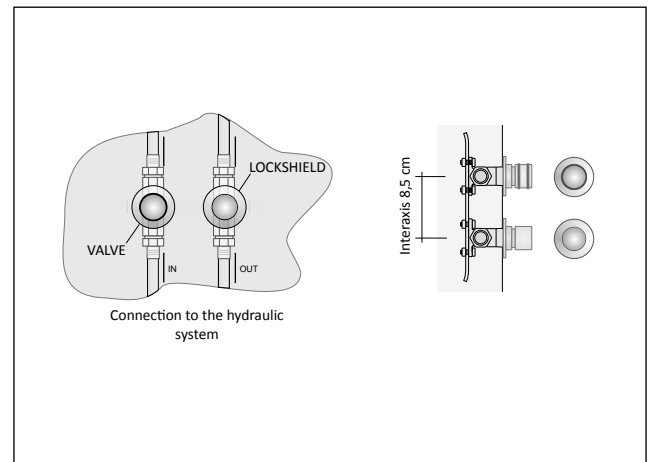
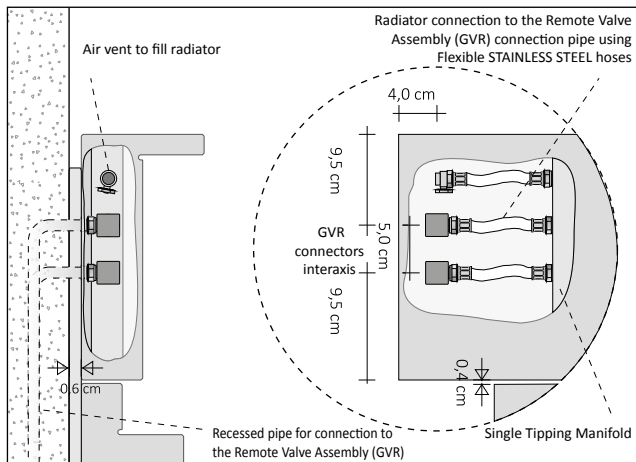

## Accessori RIFT



Hook code ZAAPRFT#...



RIFT shelf  
L 48 cm cod. ZAMRFT48#...  
L 60 cm cod. ZAMRFT60#...

| Code   | Description  | Finishes  | Price (€) |
|--|--|---|-----------|
| ZAAPRFT#...  | RIFT hook in PLATED brass  | Galvanic finish cat. G0, G1, G2, G3 and G5 (except brushed) |           |
| ZAAPRFTC#...   | RIFT hook in COLOURED brass  | Tubes Colours* cat. C0, C1, C2, C3                          |           |
| ZAMRFT4824#LNN<br>ZAMRFT6024#LNN<br>ZAMRFT4815#LNN<br>ZAMRFT6015#LNN | Wooden storage shelf for RIFT 24 dim. 48x15 cm<br>Wooden storage shelf for RIFT 24 dim. 60x15 cm<br>Wooden storage shelf for RIFT 15 dim. 48x15 cm<br>Wooden storage shelf for RIFT 15 dim. 60x15 cm | Natural Wood Finish   |           |
| ZAMRFT4824#LBC<br>ZAMRFT6024#LBC<br>ZAMRFT4815#LBC<br>ZAMRFT6015#LBC | Wooden storage shelf for RIFT 24 dim. 48x15 cm<br>Wooden storage shelf for RIFT 24 dim. 60x15 cm<br>Wooden storage shelf for RIFT 15 dim. 48x15 cm<br>Wooden storage shelf for RIFT 15 dim. 60x15 cm | Matt White Finish   |           |

Product code **RFTODDI2#DX1201609010R12**

RFTODDI2#DX120160 Article code specified in the price table  
 9010 Colour/finish code specified in the Official TUBES COLOUR CHART  
 R12 Connector code  
 Rh offset

**ADDITIONAL COLOUR CHARGES**

Finishes and Anodizing see page. 5 or the colour table provided at the end of this price list.

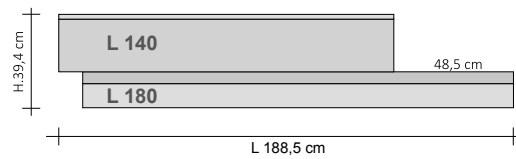
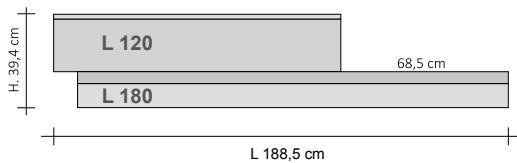
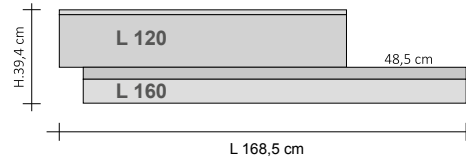
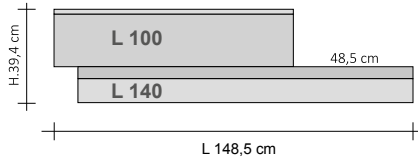

**Version offset to the Right**

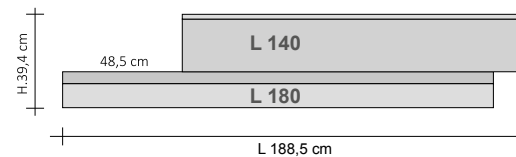
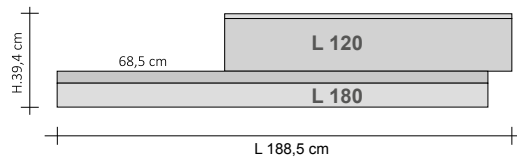
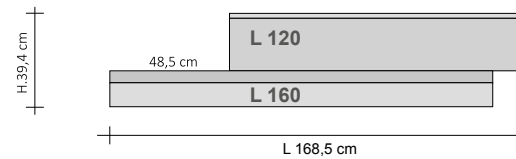
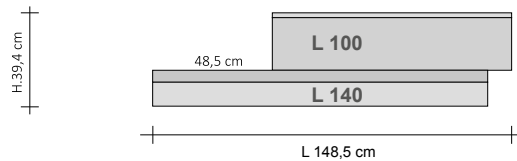

**Version offset to the Left**



**Double Offset Horizontal - Hydraulic version**

| Model   | H<br>(cm) | L<br>(cm) | Heat output in Watts<br>COLOURED version |          | Price<br>Standard White<br>Cat. C0 (€) | Price<br>Category<br>C1/C2 (€) | Price <sup>(1)</sup><br>Category<br>Cat. C3 (€) | Multi_Colour<br>Price<br>(€) |
|---|-----------|-----------|--|----------|--|--------------------------------|---|------------------------------|
|   |           |           | ΔT. 50°C                                 | ΔT. 30°C |  |                                |   |                              |
|  RFTODDI2#DX100140 | 39,4      | 148,5     | 558                                      | 297      |  |                                |   |                              |
|  RFTODDI2#SX100140 | 39,4      | 148,5     |  |          |  |                                |   |                              |
| RFTODDI2#DX120160   | 39,4      | 168,5     | 654                                      | 348      |  |                                |   |                              |
| RFTODDI2#SX120160   | 39,4      | 168,5     |  |          |  |                                |   |                              |
| RFTODDI2#DX120180   | 39,4      | 188,5     | 694                                      | 369      |  |                                |   |                              |
| RFTODDI2#SX120180   | 39,4      | 188,5     |  |          |  |                                |   |                              |
| RFTODDI2#DX140180   | 39,4      | 188,5     | 750                                      | 399      |  |                                |   |                              |
| RFTODDI2#SX140180   | 39,4      | 188,5     |  |          |  |                                |   |                              |

(1) In the MULTI-COLOUR version, the code is ODDI2M and the various colours must be specified

**Remote valve assembly – GVR**

For more information on the choice of valves, see p. 312

| Code   | Description   | Finishes             | Price (€) |
|--|---|----------------------|-----------|
|  |   |                      |           |
| GVR#1  | RECESSED Valve that can be fitted with a thermostat and Lockshield assembly for REMOTE connection | Chromed<br>Plated    |           |
| GVRTG#1...   | RECESSED thermostatic valve and Lockshield assembly for REMOTE connection*                        |                      |           |
| GVRC#1...  | RECESSED Valve that can be fitted with a thermostat and Lockshield assembly for REMOTE connection | Coloured<br>Coloured |           |
| GVRTC#1...   | RECESSED thermostatic valve and Lockshield assembly for REMOTE connection*                        |                      |           |
| Plated finishes: See table of Tubes special finishes<br>Colored Finishes: see categories C0, C1, C2 and C3 of the Tubes color chart<br>* The price does not include the cost of the thermostatic head (see page 320) |   |                      |           |

# MULTIPLE OFFSET VERTICAL RIFT 15 - HYDRAULIC VERSION

DESIGN radiator with hydraulic system in ALUMINUM

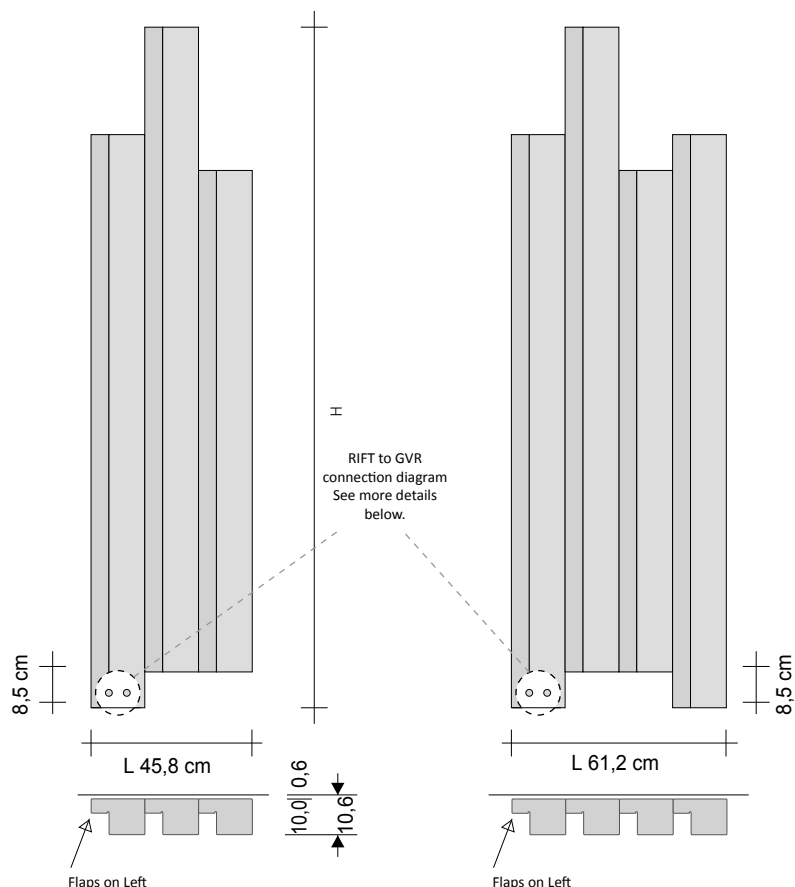

## RADIATOR connection to GVR

## Connection to the Remote Valve Assembly (GVR)

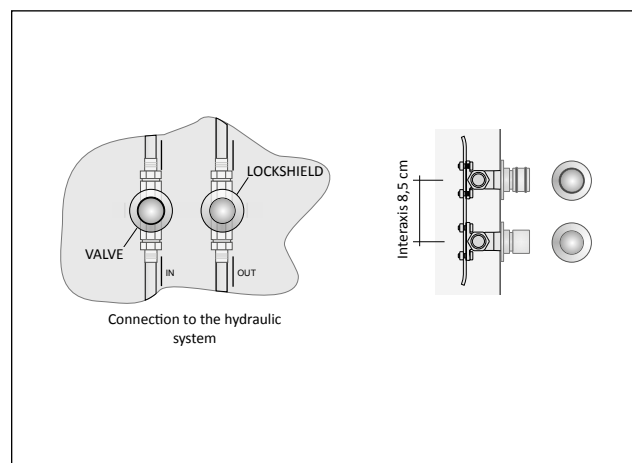
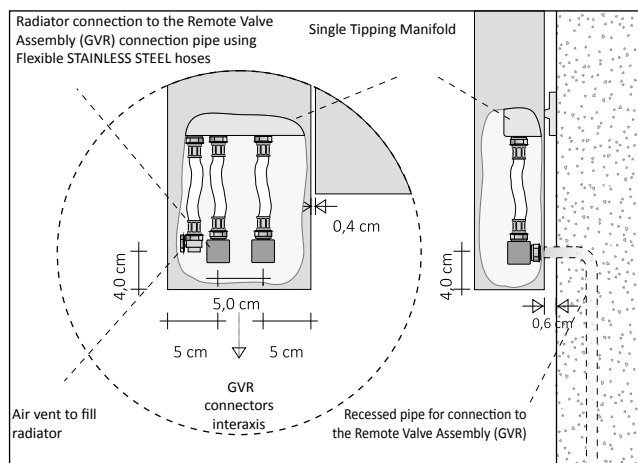

## Remote valve assembly – GVR

For more information on the choice of valves, see p. 312

|  | Code       | Description   | Finishes             | Price (€) |
|--|------------|---|----------------------|-----------|
|  | GVR#1      | RECESSED Valve that can be fitted with a thermostat and Lockshield assembly for REMOTE connection | Chromed<br>Plated    |           |
|  | GVRTG#1... | RECESSED thermostatic valve and Lockshield assembly for REMOTE connection*                        |                      |           |
|  | GVRC#1...  | RECESSED Valve that can be fitted with a thermostat and Lockshield assembly for REMOTE connection | Coloured<br>Coloured |           |
|  | GVRTC#1... | RECESSED thermostatic valve and Lockshield assembly for REMOTE connection*                        |                      |           |
| Plated finishes: See table of Tubes special finishes<br>Colored Finishes: see categories C0, C1, C2 and C3 of the Tubes color chart<br>* The price does not include the cost of the thermostatic head (see page 320) |            |   |                      |           |

Product code **RFTV15MDI3#SX1709010R12**

RFTV15MDI3#SX170 Article code specified in the price table  
 9010 Colour/finish code specified in the Official TUBES COLOUR CHART  
 R12 Connector code  
 LEFT Flap on Left

**ADDITIONAL COLOUR CHARGES**

Finishes and Anodizing see page. 5 or the colour table provided at the end of this price list.

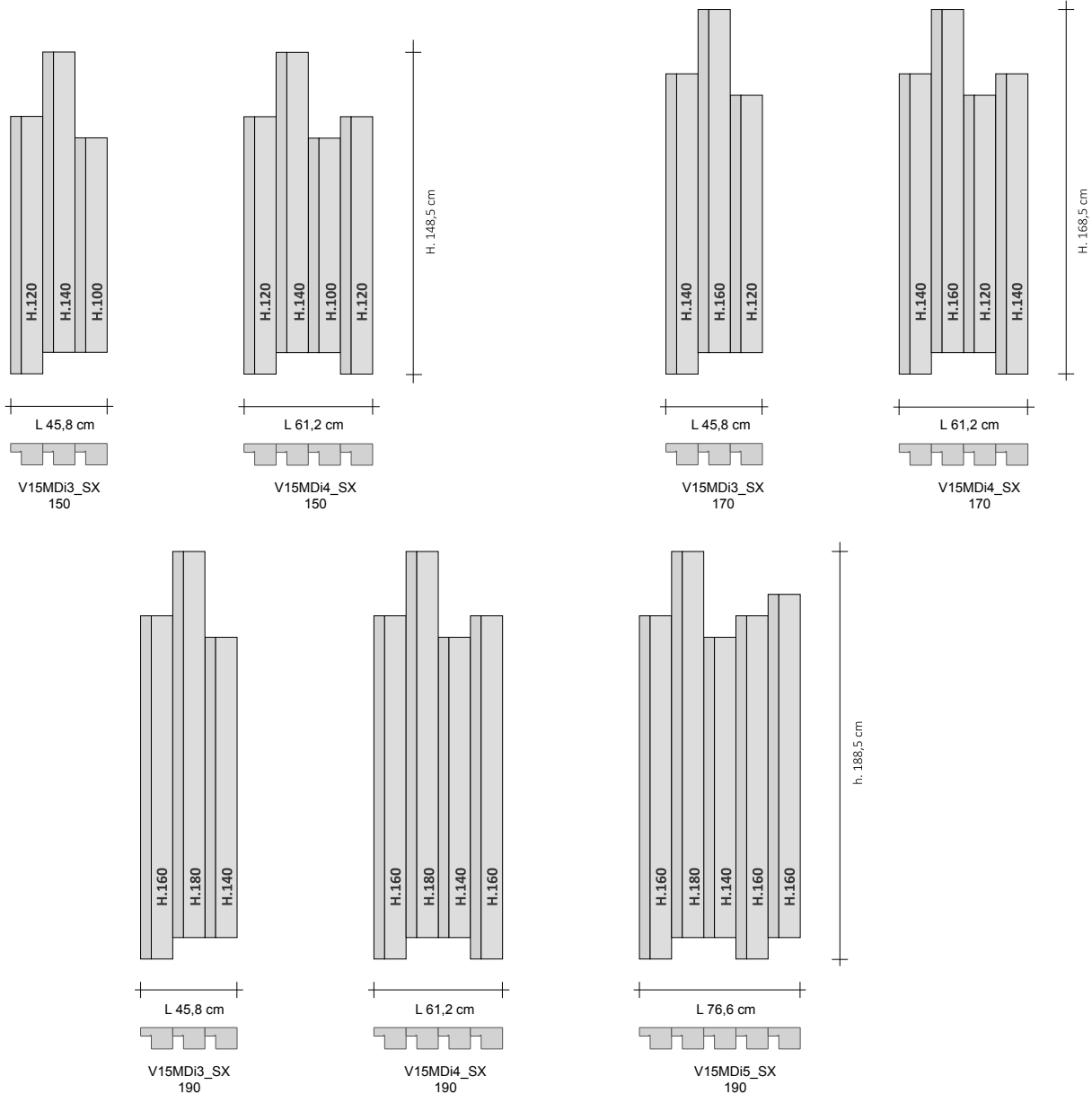

**MULTIPLE Left and Right Offset Vertical Hydraulic**

| Model            | H (cm)           | L (cm) | Heat output in Watts COLOURED version |          | Price Standard White Cat. C0 (€) | Price Category C1/C2 (€) | Price <sup>(1)</sup> Multi_Colour Category Cat. C3 (€) |
|------------------|------------------|--------|---------------------------------------|----------|----------------------------------|--------------------------|--|
|                  |                  |        | ΔT. 50°C                              | ΔT. 30°C |                                  |                          |  |
| RFTV15MDI3#SX150 | RFTV15MDI3#DX150 | 148,5  | 45,8                                  | 794      | 419                              |                          |  |
| RFTV15MDI3#SX170 | RFTV15MDI3#DX170 | 168,5  | 45,8                                  | 926      | 489                              |                          |  |
| RFTV15MDI3#SX190 | RFTV15MDI3#DX190 | 188,5  | 45,8                                  | 1059     | 559                              |                          |  |
| RFTV15MDI4#SX150 | RFTV15MDI4#DX150 | 148,5  | 61,2                                  | 1059     | 559                              |                          |  |
| RFTV15MDI4#SX170 | RFTV15MDI4#DX170 | 168,5  | 61,2                                  | 1235     | 652                              |                          |  |
| RFTV15MDI4#SX190 | RFTV15MDI4#DX190 | 188,5  | 61,2                                  | 1412     | 746                              |                          |  |
| RFTV15MDI5#SX190 | RFTV15MDI5#DX190 | 188,5  | 76,6                                  | 1764     | 932                              |                          |  |

(1) In the MULTI-COLOURED version, the code is V15MDI3M and the various colours must be specified

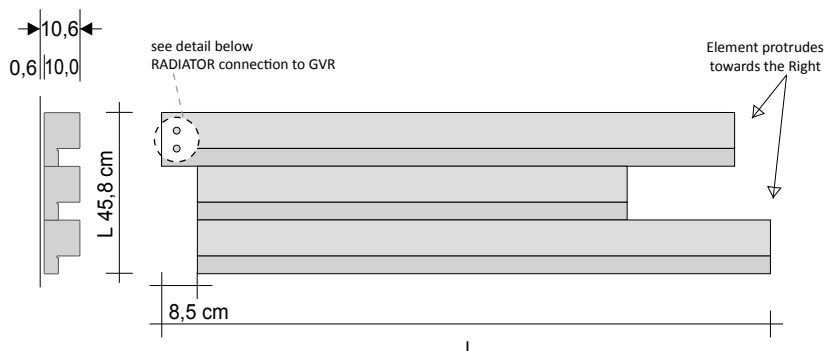

## RADIATOR connection to GVR

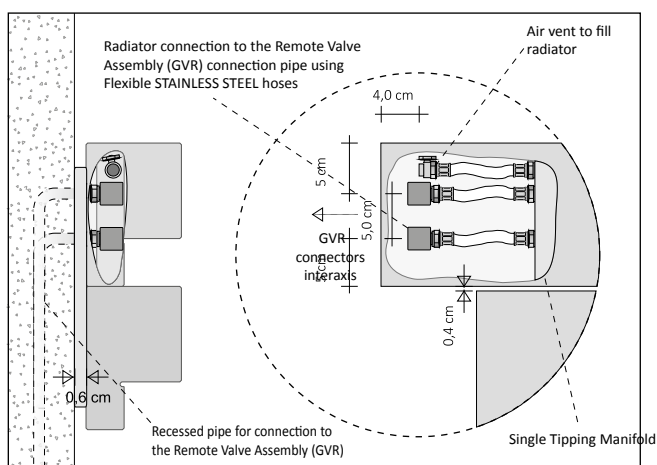

## Connection to the Remote Valve Assembly (GVR)

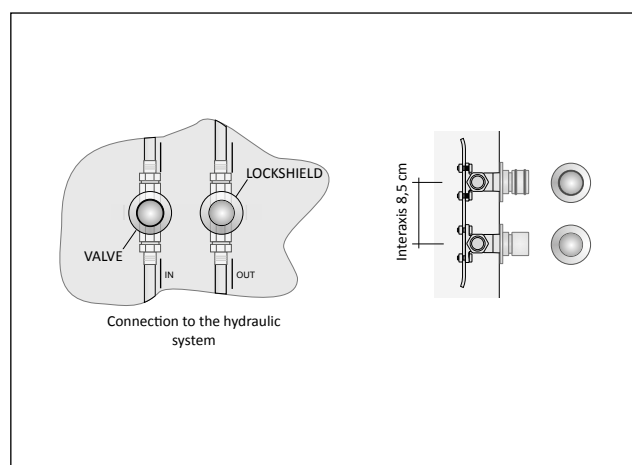

## RIFT accessories



Hook code ZAAPRFT#...



RIFT shelf  
L 48 cm cod. ZAMRFT48#...  
L 60 cm cod. ZAMRFT60#...

| Code   | Description  | Finishes  | Price (€) |
|--|--|---|-----------|
| ZAAPRFT#...  | RIFT hook in PLATED brass  | Galvanic finish cat. G0, G1, G2, G3 and G5 (except brushed) |           |
| ZAAPRFTC#...   | RIFT hook in COLOURED brass  | Tubes Colours* cat. C0, C1, C2, C3                          |           |
| ZAMRFT4824#LNN<br>ZAMRFT6024#LNN<br>ZAMRFT4815#LNN<br>ZAMRFT6015#LNN | Wooden storage shelf for RIFT 24 dim. 48x15 cm<br>Wooden storage shelf for RIFT 24 dim. 60x15 cm<br>Wooden storage shelf for RIFT 15 dim. 48x15 cm<br>Wooden storage shelf for RIFT 15 dim. 60x15 cm | Natural Wood Finish   |           |
| ZAMRFT4824#LBC<br>ZAMRFT6024#LBC<br>ZAMRFT4815#LBC<br>ZAMRFT6015#LBC | Wooden storage shelf for RIFT 24 dim. 48x15 cm<br>Wooden storage shelf for RIFT 24 dim. 60x15 cm<br>Wooden storage shelf for RIFT 15 dim. 48x15 cm<br>Wooden storage shelf for RIFT 15 dim. 60x15 cm | Matt White Finish   |           |

Product code **RFTO15MDI3#SX1709010R12**

RFTO15MDI3#SX170 Article code specified in the price table  
 9010 Colour/finish code specified in the Official TUBES COLOUR CHART  
 R12 Connector code  
 LEFT offset

**ADDITIONAL COLOUR CHARGES**

Finishes and Anodizing see page. 5 or the colour table provided at the end of this price list.

**Version offset to the Right**

**Version offset to the Left**

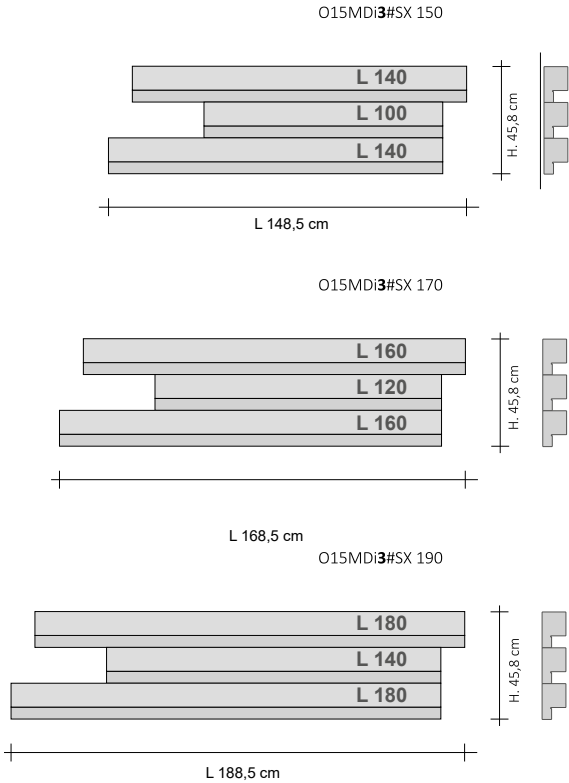
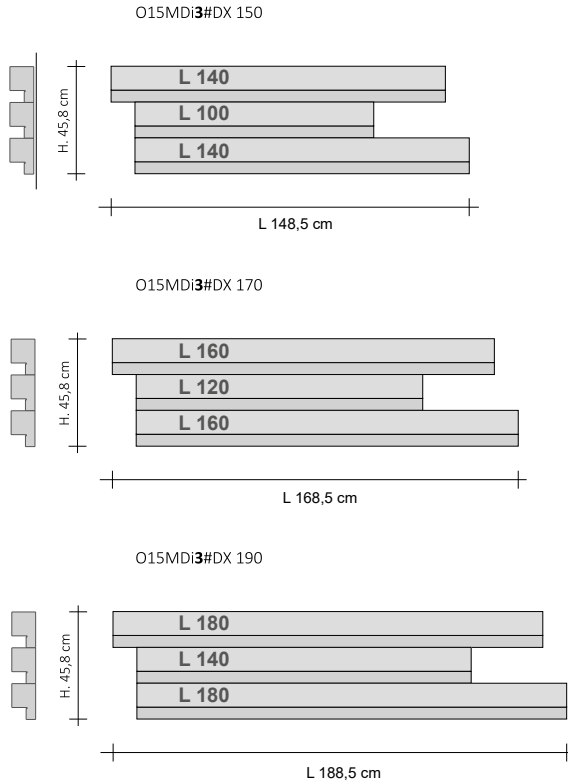

**MULTIPLE 15 offset horizontal 15, hydraulic version RIGHT and LEFT**

| Model            | H (cm) | L (cm) | Heat output in Watts COLOURED version |          | Price Standard White Cat. C0 (€) | Price Category C1/C2 (€) | Price <sup>(1)</sup> Multi_Colour Category Cat. C3 (€) | Price (€) |
|------------------|--------|--------|---------------------------------------|----------|----------------------------------|--------------------------|--|-----------|
|                  |        |        | ΔT. 50°C                              | ΔT. 30°C |                                  |                          |  |           |
| RFTO15MDI3#DX150 | 45,8   | 148,5  | 838                                   | 445      |                                  |                          |  |           |
| RFTO15MDI3#DX170 | 45,8   | 168,5  | 970                                   | 516      |                                  |                          |  |           |
| RFTO15MDI3#DX190 | 45,8   | 188,5  | 1103                                  | 586      |                                  |                          |  |           |

(1) In the MULTI-COLOUR version, the code is O15MDI3M and the various colours must be specified

**Remote valve assembly – GVR**

For more information on the choice of valves, see p. 312

| Code       | Description   | Finishes          | Price (€) |
|------------|---|-------------------|-----------|
| GVR#1      | RECESSED Valve that can be fitted with a thermostat and Lockshield assembly for REMOTE connection | Chromed Plated    |           |
| GVRTG#1... | RECESSED thermostatic valve and Lockshield assembly for REMOTE connection*                        |                   |           |
| GVRC#1...  | RECESSED Valve that can be fitted with a thermostat and Lockshield assembly for REMOTE connection | Coloured Coloured |           |
| GVRTC#1... | RECESSED thermostatic valve and Lockshield assembly for REMOTE connection*                        |                   |           |

Plated finishes: See table of Tubes special finishes  
 Colored Finishes: see categories C0, C1, C2 and C3 of the Tubes color chart  
 \* The price does not include the cost of the thermostatic head (see page 320)